

U S A



## 45 years of success 45 años de éxitos

Since 1978 Egoluce, founded by three friends: Bruno, Mario e Renato with a great lighting experience and passion, has been manufacturing 100% Made in Italy lighting products, collaborating with Italian companies and artisans to offer the highest quality and long-lasting light fixtures for various applications. Experience, innovation, and technology are the values that have made Egoluce one of the important players in the worldwide lighting industry.

Our know-how and attention to detail in every production phase have been the main aspects of Egoluce success. We constantly research and test innovative solutions to develop products with the latest materials, technologies, and design trends. Our products are designed to be energy efficient and eco-friendly, contributing to environmental sustainability. At Egoluce, we believe that modern lighting

*Desde 1978 Egoluce, fundada por tres amigos: Bruno, Mario y Renato con una gran experiencia y pasión por la iluminación, fabrica productos de iluminación 100% Made in Italy, trabajando con empresas y artesanos italianos para ofrecer luminarias de la más alta calidad y durabilidad para diferentes aplicaciones. Experiencia, innovación y tecnología son los valores que han convertido a Egoluce en uno de los principales actores de la industria de la iluminación en todo el mundo.*

*Nuestro saber hacer y nuestra atención al detalle en cada fase de la producción han sido aspectos clave del éxito de Egoluce. Investigamos y probamos constantemente soluciones innovadoras para desarrollar productos con los últimos materiales, tecnologías y tendencias de diseño. Nuestros productos están diseñados para ser eficientes energéticamente y respetuosos con el medio ambiente, contribuyendo así a la sostenibilidad medioambiental.*

controls should consider the human biorhythm and positively impact our health and well-being. We are dedicated to create lighting solutions that enhance the perception of the spaces and provide an unforgettable sensorial experience.

Egoluce offers lighting solutions to Architects, Lighting Specialists, Designers, and Specifiers. We also provide our customers with tailored solutions and custom products for every market demand.

At Egoluce, we are proud to be part of the great Italian tradition of craftsmanship and design.

*En Egoluce creemos que los sistemas modernos de control de la iluminación deben tener en cuenta el biorritmo humano y repercutir positivamente en nuestra salud y bienestar. Nos dedicamos a crear soluciones técnicas de iluminación que mejoran la percepción de los espacios y proporcionan una experiencia sensorial inolvidable.*

*Egoluce ofrece soluciones de iluminación a arquitectos, especialistas en iluminación, diseñadores y técnicos. También ofrecemos a nuestros clientes soluciones a medida y productos personalizados para cada necesidad del mercado.*

*En Egoluce estamos orgullosos de formar parte de la gran tradición italiana de artesanía y diseño.*

100% MADE IN ITALY 



## 4 good reasons to choose Egoluce

### 4 buenas razones para elegir EGOLUCE

#### 1 – LED

EGOLUCE products are equipped with latest generation LED. We use different technologies to grant very good performances:

- Excellent luminous efficacy.
- Very good colour rendering.
- Different light colours.
- Designed to last for a very long time.

#### 2 – MATERIALS

We have selected best materials for products that must have long-lasting life:

- ALUMINIUM – ductile and unalterable grants an optimal heat dissipation (important to grant longest operational life of LED).
- STAINLESS STEEL – the best warranty for fixtures that must resist to atmospheric or chemical agents (salt, chlorine, etc.)
- CLEAR CRYSTAL: to create objects with unique light effects and reflections.
- METHACRYLATE: to diffuse and at the same time shade the punctual light of LED.

#### 3- GENERAL FEATURES

Small details that makes a great product:• LED unit easy to replace, the light source can be replaced as if it were a common lamp.

- Proper heat sink device placed in every product to grant maximum lifetime for the LED.
- Most of the products can be operated both at 350 mA or 500 mA.
- Optimization of the luminous flux obtained by the use of lenses and reflectors.

#### 4 – SAFETY

A granted quality

- All our models undergo rigorous temperature and functional testing.
- All electronic components displayed in our catalogue (drivers, dimmers) are marked with European quality certification (ENEC).
- 100% of our products undergo quality and

#### 1 - LED

Los productos EGOLUCE están equipados con fuentes LED de última generación. Las distintas tecnologías aplicadas garantizan un excelente rendimiento:

- Excelente rendimiento lumínico.
- Excelente valor de reproducción cromática.
- Varias temperaturas de color.
- Fuentes diseñadas para durar.

#### 2 - MATERIALES

Hemos seleccionado los mejores materiales para luminarias que deben durar en el tiempo:- ALUMINIO: dúctil e inalterable, garantiza una excelente dispersión del calor (importante para optimizar la vida útil de los LED).

- ACERO INOXIDABLE: la mejor garantía para luminarias que deben resistir agentes atmosféricos o químicos (sal, cloro, etc.).
- CRISTAL CLARO: para crear objetos con efectos de luz y proyecciones únicos.
- METACRYLATE: para difundir y al mismo tiempo enmascarar la luz puntual del LED

#### 3 - CARACTERÍSTICAS GENERALES

Pequeños detalles que hacen grande a un producto:

- Fácil sustitución por LED, la fuente de luz se puede sustituir tan fácilmente como una bombilla normal.
- Presencia de disipadores de calor adecuados en todos los productos para garantizar la durabilidad de los LED.
- Posibilidad de alimentar la mayoría de los productos con 350 mA o 500 mA
- Optimización del flujo luminoso mediante el uso de lentes o parábolas.

#### 4 - SEGURIDAD

Calidad garantizada:

- Todos los modelos se someten a pruebas térmicas y funcionales.
- Todos los componentes electrónicos ofrecidos en el catálogo (controladores, atenuadores) llevan la marca de calidad europea (ENEC).
- El 100% de la producción se somete a pruebas de calidad y funcionamiento antes de salir al mercado.



## Fixture repairable. Aparato reparable.

EGOLUCE models are designed and produced according to the best quality standards existing on the technical lighting market following the “well made” standard: in full compliance with both quality and regulatory rules, in the fields of application of our products.

- Care and precision of the design aimed at a production of the highest quality.
- Excellent quality in the manufacture of products thanks to: high selection of high-end components, attention to coating, precise and punctual assembly and packaging, perfect for all types of shipping.
- Extremely severe durability and reliability tests: both on individual components and on final products.

These targets guarantees 5 years warranty on correctly installed EGOLUCE products and components following the instruction for users.

Los modelos de EGOLUCE se diseñan y fabrican con los más altos estándares de calidad del mercado de la iluminación, siguiendo el criterio de “hacer las cosas bien” en pleno cumplimiento de las normas tanto de calidad como reglamentarias en los ámbitos de aplicación de nuestros productos.

- Cuidado y precisión en el diseño para una producción de máxima calidad.
- Excelente calidad en la fabricación de productos gracias a: selección de componentes de alta gama, cuidado en el acabado, montaje preciso y puntual, embalaje impecable para todo tipo de envíos.
- Pruebas extremadamente rigurosas de durabilidad y fiabilidad, tanto en componentes individuales como en aparatos acabados.

Esto asegura una garantía de 5 años para los productos y componentes EGOLUCE correctamente instalados según las hojas de instrucciones.



Products without the ETL certification mark are wired 110V

Los productos sin la marca de certificación ETL están conectados a 110V



# Layout

Still Life  
Configuración

Code  
Código

Name  
Nombre

Picture  
Fotos

**Zeppelin**  
Design U.T. EGOLUCE

Plasterboard spring included  
Muelle de escayola incluido

ROUND / RONDA  
Ø 1.57"

FRAMEWORK / MARCO  
1.57"x1.57"

Finish	LED max 2W 500mA	209lm	4000K
/W	LED max 2W 500mA	209lm	4000K
/WW	LED max 2W 500mA	199lm	3000K
/XW	LED max 2W 500mA	189lm	2700K

Wide beam / Haz de luz ancho

ACCESSORIES / ACCESORIOS

DRIVERS / CONDUCTORES

0216 Plastic Box / Caja de plástico

0220 Kit draining junction box + IP68 connector / Kit de encajador de drenaje + conector IP68

0127 Drivers 500 mA - 1-6 Zeppelin

0128 Drivers 350 mA - 1-10 Zeppelin

0141/DIM Multi-power dimmable driver PUSH - 1...10V - 1-11 Zeppelin

0141/DALI Multi-power DALI dimmable driver - 1-11 Zeppelin

0145/DALI Multi-power DALI dimmable driver - 1-21 Zeppelin

Only serial connection - Solo conexión serie

Technical Data  
Datos técnicos

Technical Drawing  
Dibujo técnico

Accessories  
Accesorios

Drivers  
Conductores

## PRODUCT / PRODUCTO

Bold characters are used for code and specifications needed to identify the product code to be indicated in orders.

Los caracteres en negrita se utilizan para el código y las especificaciones que contribuyen a la definición del producto que debe indicarse en los pedidos.

Finish  
Acabado

Light color  
Color claro

Gross Lumen Package  
Lúmenes nominales

Code	Finish	Light color	Gross Lumen Package	Weight
<b>6348</b> _ / _	<b>.33</b> Stainless steel AISI 316L - Acero cepillado			0.18 lb
				1,26"
	Source LED cod.			
	/W	LED max 2W 500mA	209lm	4000K
	/WW	LED max 2W 500mA	199lm	3000K
	/XW	LED max 2W 500mA	189lm	2700K

## SIGNS / SÍMBOLOS

- Floor - Table  
Suelo - Mesa
- Wall  
Pared
- Suspension - Ceiling  
Suspensión - Techo
- Cut out (round)  
Agujero empotrado (redondo)
- Recessed hole (square)  
Agujero empotrado (cuadrado)
- Walk over fitting  
Luminarias transitables
- Drive over fittings  
Calzadas
- Surface temperature <.....°C  
Temperatura superficial &t;.....°C
- Converter not included  
Fuente de alimentación excluida
- Converter included  
Fuente de alimentación incluida
- Cable length  
Longitud del cable
- Dimmer included  
Regulador de intensidad incluido
- CRI >90
- Fixture repairable  
Luminaria reparable
- Degrees  
Grados
- Turnable  
Ajustable
- Weight  
Peso
- Rechargeable battery  
Batería recargable
- IP65 Water resistant  
Resistente al agua
- Tunable white  
TW

## IP / IP

- 1st digit:** protection against penetration by solid bodies.  
1er dígito protección contra la penetración de sólidos.
- 0 No protection.  
Desprotegido.
- 1 Protected against solid matters (over 1.97").  
Protegido de sólidos mayores de 1.97".
- 2 Protected against solid matters (over 12mm).  
Protegido de sólidos mayores de 12 mm.
- 3 Protected against solid matters (over 0.98").  
Protegido de sólidos mayores de 0.98".
- 4 Protected against solid matters (over 0.039").  
Protegido de sólidos superiores a 0.039".
- 5 Dust proof.  
Protegido contra el polvo.
- 6 Fully dust proof.  
Totalmente protegido contra el polvo.

- 2nd digit:** protection against penetration by water.  
2º dígito: protección contra la penetración de agua.
- 0 No protection.  
Desprotegido.
- 1 Protected against drops of water falling vertically.  
Protegido contra la caída vertical de gotas de agua.
- 3 Rain proof fixture.  
Protegido contra la lluvia.
- 4 Splash proof fixture.  
Protegido contra salpicaduras.
- 5 Water jet proof.  
Protegido contra chorros de agua.
- 6 Wave proof.  
Protegido contra las olas.
- 7 Watertight immersion fixture.  
Protegido contra la inmersión.

## MARK / MARCAS

- Fixture on Class II, with double or reinforced insulation.  
Luminaria de clase II con aislamiento doble o reforzado.
- SELV fixture with remote transformer.  
Luminaria de muy baja tensión con transformador remoto.
- Fixture ready for installation on normally inflammable surfaces.  
Luminaria adecuada para su instalación en superficies normalmente inflamables.



## LIGHT COLOR CODES / CÓDIGOS DE COLOR DE LAS LUCES

- /XW Extra White Led 2700K
- /WW Warm White Led 3000K
- /W Natural White Led 4000K
- /B Blue Led

## OPTION CODES / CÓDIGO DE VERSIÓN

- /EM Emergency  
Emergencia
- /DIM Dimming  
Regulable
- /DALI Dimming  
Regulable
- /ST Satin diffuser  
Con difusor satinado
- /TR Transparent diffuser  
Con difusor transparente



## Finishes / Acabados

 <p><b>.00</b> Clear <i>Transparente</i></p>	 <p><b>.01</b> White <i>Blanco</i></p>	 <p><b>.02</b> Black <i>Negro</i></p>	 <p><b>.05</b> Red <i>Rojo</i></p>
 <p><b>.06</b> Green <i>Verde</i></p>	 <p><b>.14</b> Blackboard <i>Pizarra</i></p>	 <p><b>.21</b> Shiny golded <i>Oro brillante</i></p>	 <p><b>.25</b> Golded Satin <i>Satén dorado</i></p>
 <p><b>.29</b> Gold leaf <i>Hoja de Oro</i></p>	 <p><b>.30</b> Silver leaf <i>Hoja de plata</i></p>	 <p><b>.31</b> Chromed <i>Cromado</i></p>	 <p><b>.32</b> Nickel mat <i>Níquel satinado</i></p>
 <p><b>.33</b> Stainless steel AISI 316L <i>Acero cepillado AISI 316L</i></p>	 <p><b>.34</b> Painted corten finishing <i>Corten pintado</i></p>	 <p><b>.39</b> Painted Anthracite finishing <i>Pintado antracita</i></p>	 <p><b>.45</b> Aluminium anodized <i>Aluminio anodizado</i></p>
 <p><b>.50</b> Crystal <i>Cristal</i></p>	 <p><b>.56</b> Mirror <i>Espejo</i></p>	 <p><b>.57</b> Blown white glass <i>Vidrio blanco soplado</i></p>	 <p><b>.85</b> Painted silver finishing <i>Plata pintada</i></p>
 <p><b>.86</b> Painted gold finishing <i>Oro pintado</i></p>	 <p><b>.87</b> Painted copper finishing <i>Cobre pintado</i></p>	 <p><b>.88</b> Painted bronze finishing <i>Bronce pintado</i></p>	

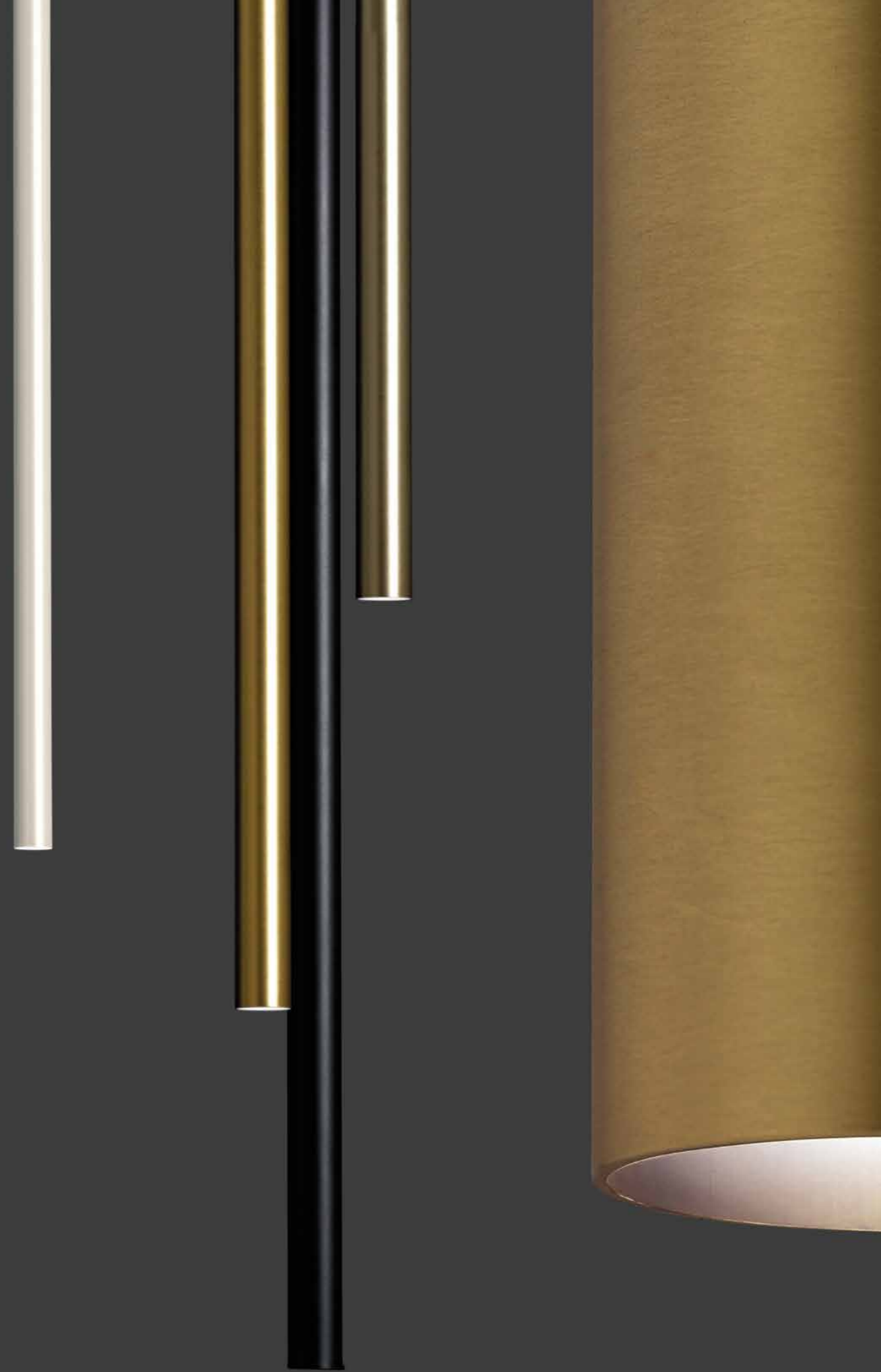



# Index / Índice



Lancia Tonda  
14

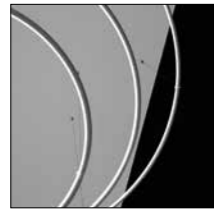

Lancia Tonda XL /XXL  
20



Lancia Tonda System  
24

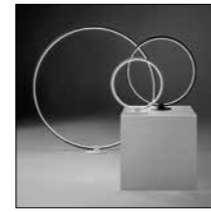

Lancia Tonda  
32



Lancia  
38



Lancia System  
44



Lancia no limits  
48

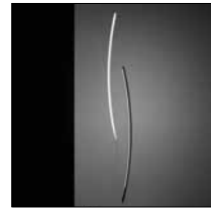

Lancia di Achille  
54

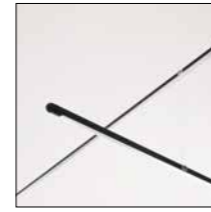

Matita  
60



Radar  
68

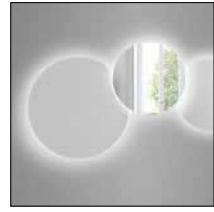

Moonlight  
74



Tiny  
90



Newton Spots  
108



Newton Spots Slim  
118



Newton Spots Flat  
120



Newton Track 48V  
124

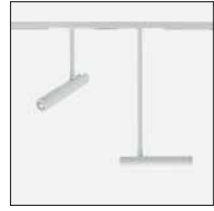

Newton Slim Track 48V  
126



Newton Flat Track 48V  
130



Newton System  
134

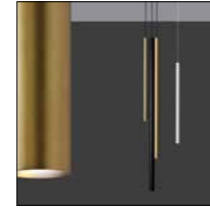

Stick System  
144



Linea  
150



Joy  
164



Lara  
190



Lara Maxi  
192



Wanda  
202



Wanda System  
212

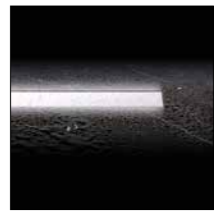

Spooky  
220



Zeppelin  
242



Zeppelin 25 Plus  
244



Zeppelin Maxi  
246



Zeppelin COB  
250



Zeppelin Orientabile  
252



Tris  
254



Drive  
258



Vista  
262



Kross  
268



Step  
272



Soft  
276



Cerchio  
280



Vision 1  
288



Vision 3  
290



Top  
294



Top Mini  
296



Dot  
298



Pix  
302



Sirio  
306



Alcor  
310



Vega  
314



Fire  
318



Ice  
322



Snorky  
326



Cerchietto  
330



Cruise  
334



Spoon  
338



Slot  
346

INDOOR

# Lancia

Design P. Peperè



Adjustable suspension lamp with both direct or diffused light. A body of extruded aluminum with an opal polycarbonate diffuser, injection-molded ABS caps, and a transparent coaxial power cable of 250 cm. Lancia System offers multiple compositions. The coupling system allows you to rotate the profile and direct the light in the desired direction. The elegant line gives it an appearance that adapts well to any space, from classic to modern interiors.

*Lámpara de suspensión regulable con ambas luz directa o difusa. Un cuerpo de aluminio extruido con un difusor de policarbonato opalino, tapas de ABS moldeadas por inyección y un cable de alimentación coaxial transparente de 250 cm. El sistema Lancia ofrece múltiples composiciones. El sistema de acoplamiento permite girar el perfil y dirigir la luz en la dirección deseada. Su elegante línea le confiere un aspecto que se adapta bien a cualquier espacio, desde los interiores clásicos a los modernos.*

# Lancia Tonda

Design P. Pepere





# Lancia Tonda

Design P. Pepere



Dimmable on request  
Regulable bajo pedido

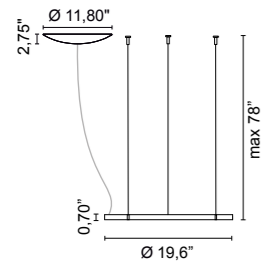

**U1566** \_ \_ / \_ \_ 2.65 lb

- .01**  White - Blanco
- .02**  Black - Negro
- .25**  Gilded satin - Oro satinado
- .31**  Chromed - Cromado
- .85**  Painted silver finishing - Plata pintada
- .86**  Painted gold finishing - Oro pintado
- .87**  Painted copper finishing - Cobre pintado
- .88**  Painted bronze finishing - Bronce pintado

<b>/W</b>	4000K	LED 27W CRI>90	3390lm
<b>/WW</b>	3000K	LED 27W CRI>90	3030lm
<b>/XW</b>	2700K	LED 27W CRI>90	2835lm

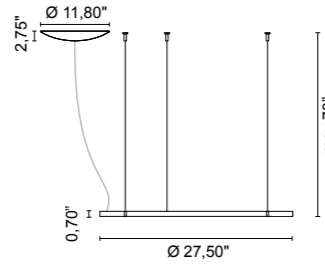

**U1562** \_ \_ / \_ \_ 3.09 lb

- .01**  White - Blanco
- .02**  Black - Negro
- .25**  Gilded satin - Oro satinado
- .31**  Chromed - Cromado
- .85**  Painted silver finishing - Plata pintada
- .86**  Painted gold finishing - Oro pintado
- .87**  Painted copper finishing - Cobre pintado
- .88**  Painted bronze finishing - Bronce pintado

<b>/W</b>	4000K	LED 37,5W CRI>90	4746lm
<b>/WW</b>	3000K	LED 37,5W CRI>90	4242lm
<b>/XW</b>	2700K	LED 37,5W CRI>90	3969lm

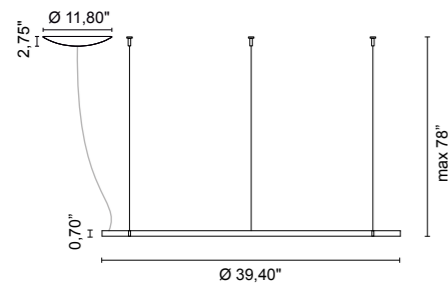

**U1563** \_ \_ / \_ \_ 3.75 lb

- .01**  White - Blanco
- .02**  Black - Negro
- .85**  Painted silver finishing - Plata pintada
- .86**  Painted gold finishing - Oro pintado
- .87**  Painted copper finishing - Cobre pintado
- .88**  Painted bronze finishing - Bronce pintado

<b>/W</b>	4000K	LED 54W CRI>90	6780lm
<b>/WW</b>	3000K	LED 54W CRI>90	6060lm
<b>/XW</b>	2700K	LED 54W CRI>90	5670lm

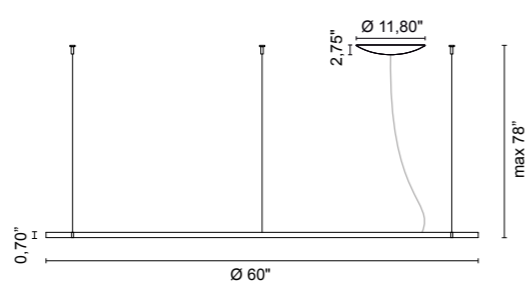

**U1564** \_ \_ / \_ \_ 5.51 lb

- .01**  White - Blanco
- .02**  Black - Negro
- .85**  Painted silver finishing - Plata pintada
- .86**  Painted gold finishing - Oro pintado
- .87**  Painted copper finishing - Cobre pintado
- .88**  Painted bronze finishing - Bronce pintado

<b>/W</b>	4000K	LED 81W CRI>90	10170lm
<b>/WW</b>	3000K	LED 81W CRI>90	9090lm
<b>/XW</b>	2700K	LED 81W CRI>90	8505lm



Electric cable length 98,43"  
Longitud del cable eléctrico 98,43"

## OPTIONAL



Displacement component  
Elemento de descentralización

**0536** \_ \_

- .01**  White - Blanco
- .02**  Black - Negro
- .25**  Gilded satin - Oro satinado
- .31**  Chromed - Cromado

## FINISHES CODES - CÓDIGOS DE ACABADOS

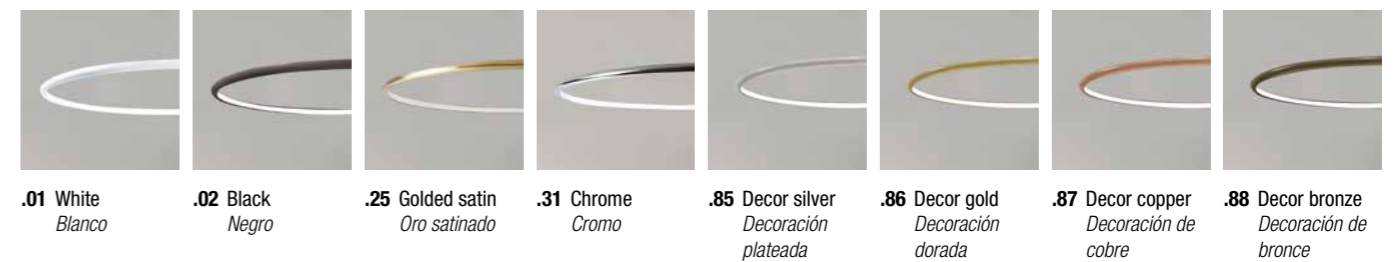

- .01** White  
Blanco
- .02** Black  
Negro
- .25** Gilded satin  
Oro satinado
- .31** Chrome  
Cromo
- .85** Decor silver  
Decoración plateada
- .86** Decor gold  
Decoración dorada
- .87** Decor copper  
Decoración de cobre
- .88** Decor bronze  
Decoración de bronce

# Lancia Tonda

Design P. Peperè



Dimmable on request  
Regulable bajo pedido

**U1573**.\_.\_ / \_.\_ 16.00 lb

**.01**  White - Blanco

**.02**  Black - Negro

**/W** LED 172,5W 21696lm 4000K

**/WW** LED 172,5W 19392lm 3000K

**/XW** LED 172,5W 18144lm 2700K



On request are available compositions with rings with different diameter.

*A petición están disponibles las composiciones con anillos de diferente diámetro.*

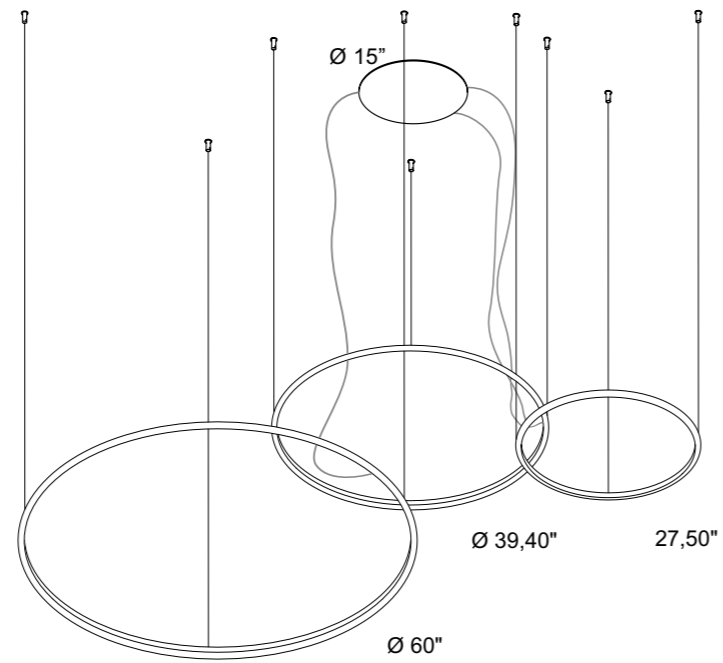
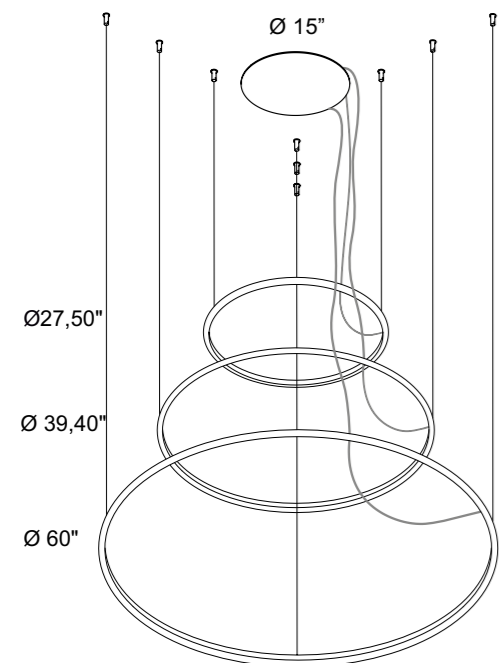

**U1574**.\_.\_ / \_.\_ 16.00 lb

**.01**  White - Blanco

**.02**  Black - Negro

**/W** LED 172,5W 21696lm 4000K

**/WW** LED 172,5W 19392lm 3000K

**/XW** LED 172,5W 18144lm 2700K



On request are available compositions with rings with different diameter.

*A petición están disponibles las composiciones con anillos de diferente diámetro.*

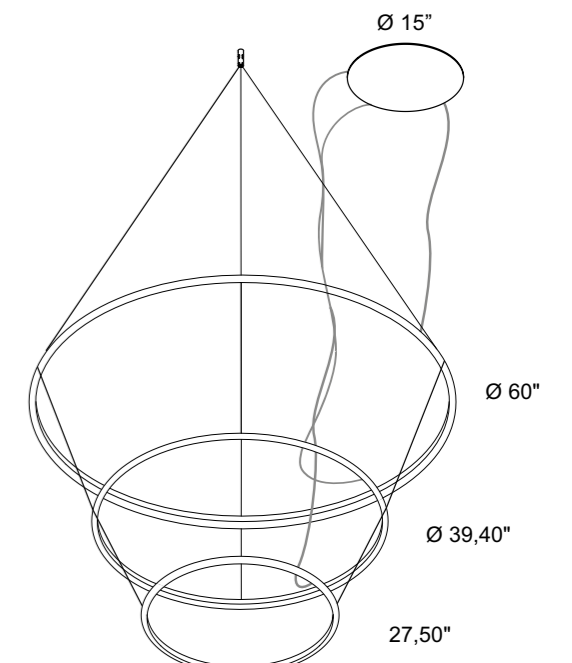
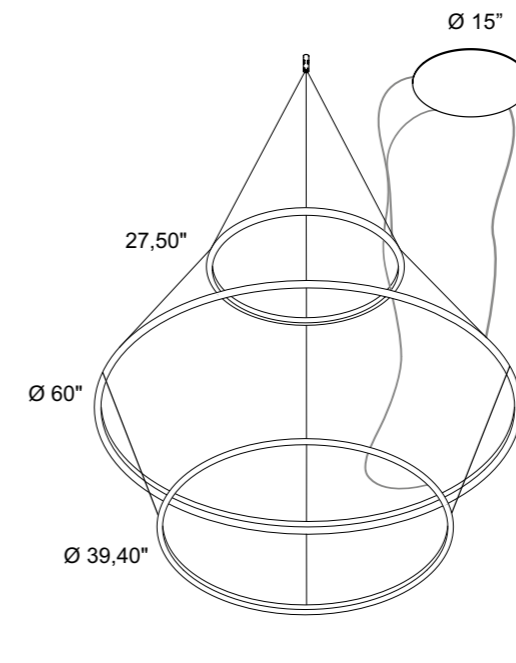

# Lancia Tonda XL/XXL

Design P. Peperè

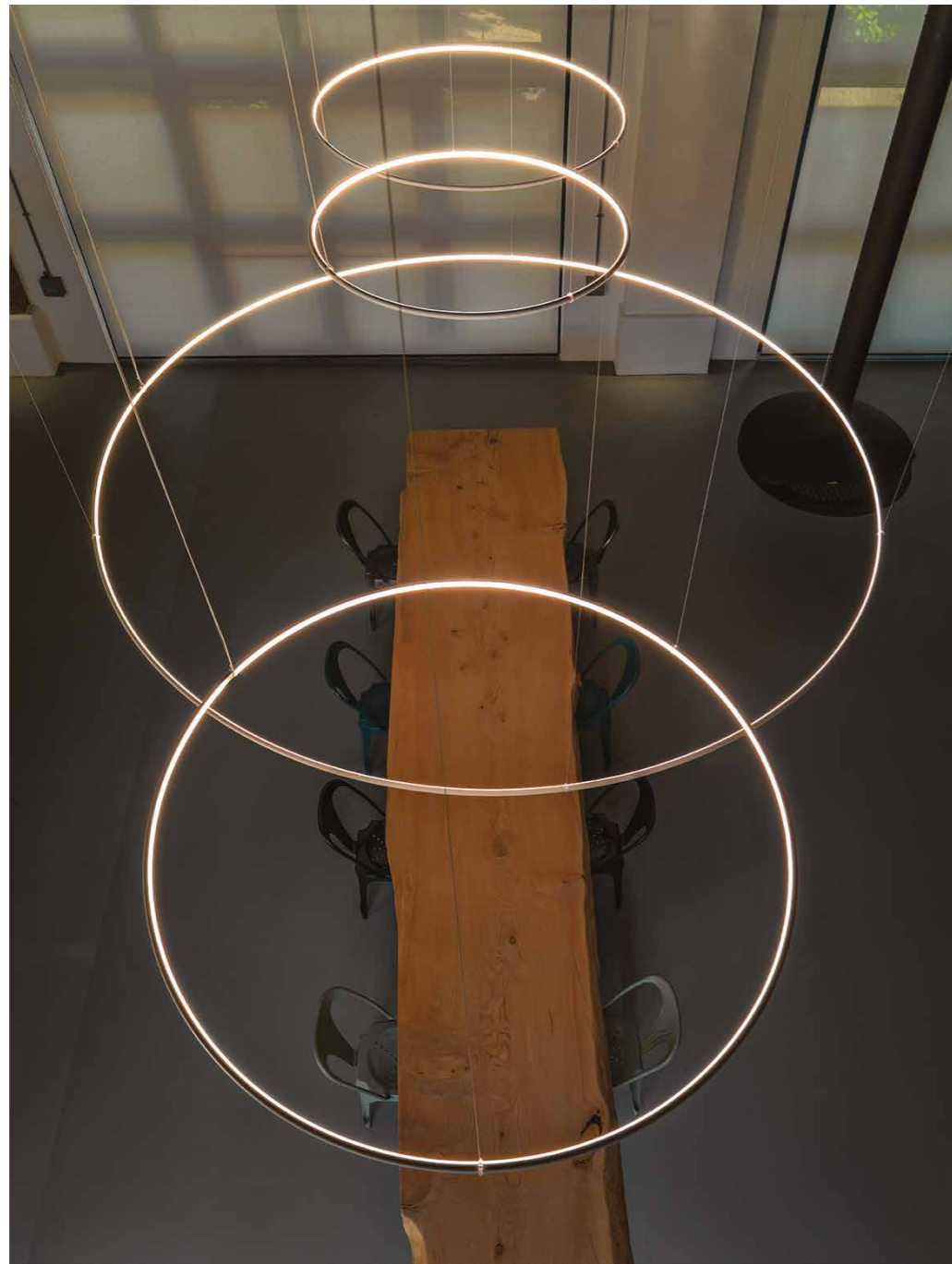

# Lancia Tonda XL/XXL

Design P. Pepere



Dimmable on request  
Regulable bajo pedido

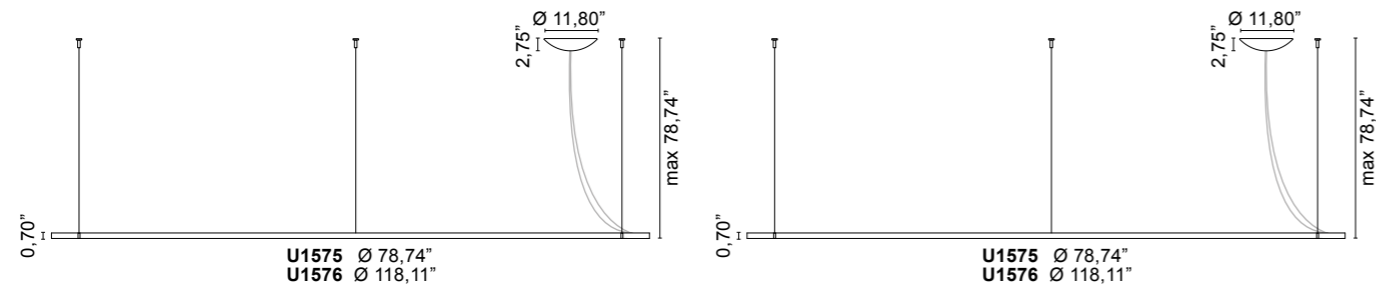

**U1575** 6.61 lb  
**U1576** 11.02 lb

.01	White - Blanco	
.02	Black - Negro	

/W	4000K	LED 67W CRI>90	7560lm
/WW	3000K	LED 67W CRI>90	7140lm
/XW	2700K	LED 67W CRI>90	6720lm

**U1576** 11.02 lb

.01	White - Blanco	
.02	Black - Negro	

/W	4000K	LED 96W CRI>90	10800lm
/WW	3000K	LED 96W CRI>90	10120lm
/XW	2700K	LED 96W CRI>90	9600lm

## ASSEMBLY SCHEME ESQUEMA DE MONTAJE

The lamp is supplied in 4 separate sectors to be assembled during installation  
La lámpara se suministra en 4 secciones separadas que deben ensamblarse durante la instalación

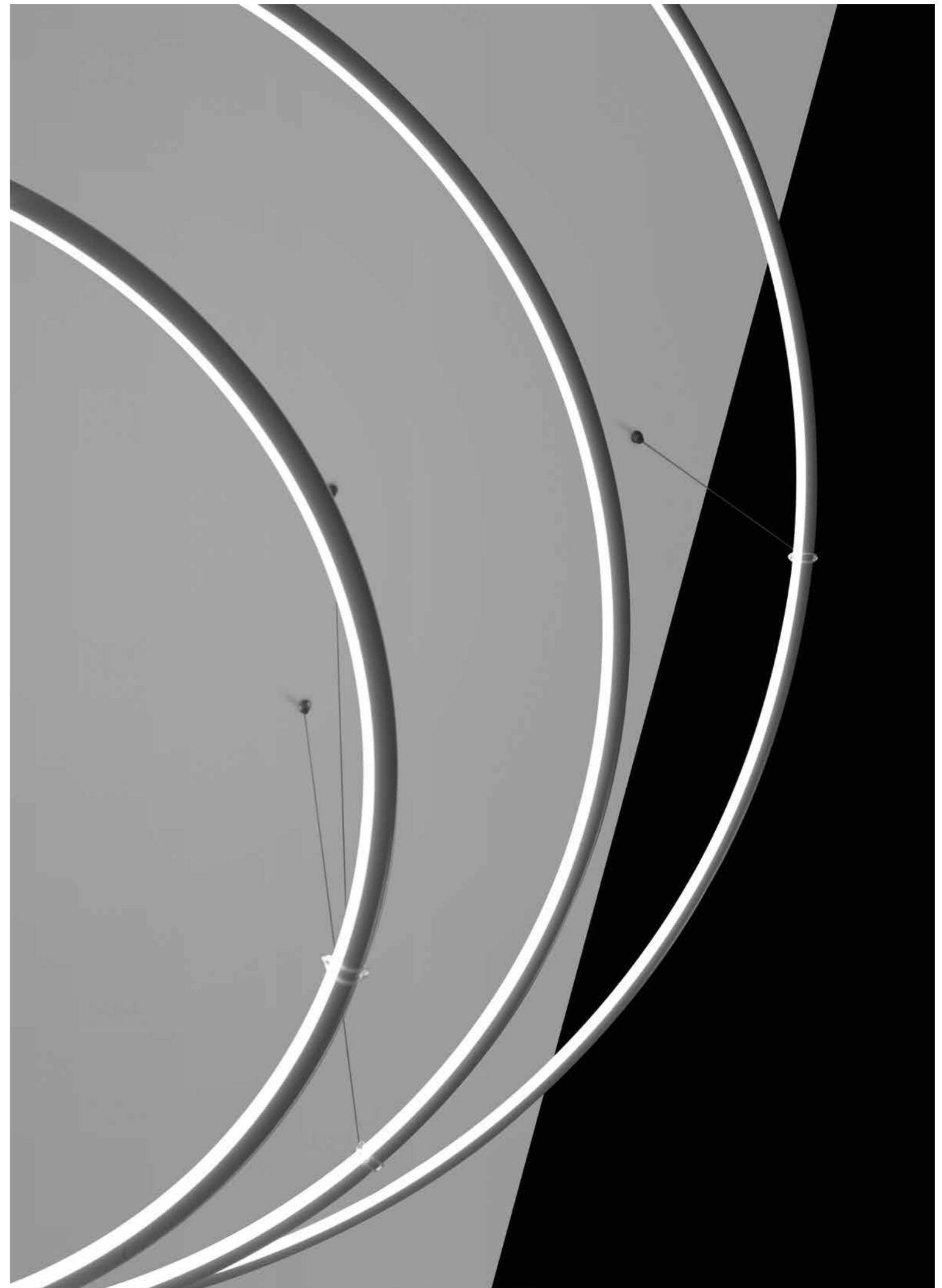
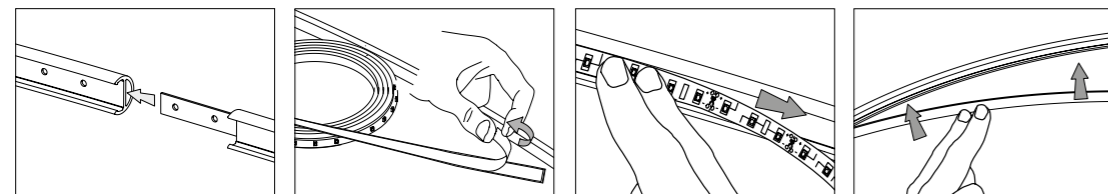
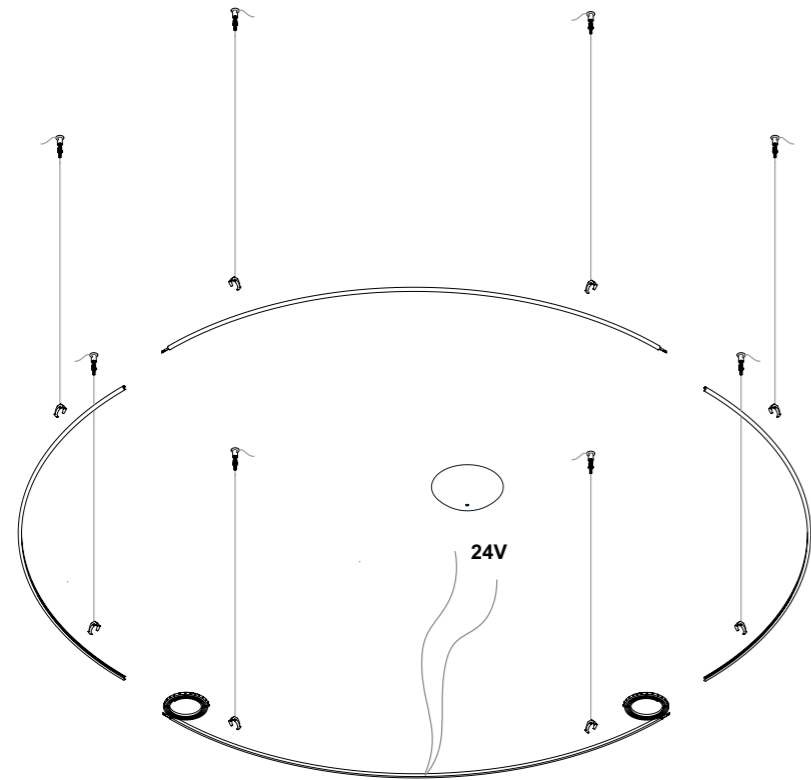

# Lancia Tonda System

Design P. Pepere

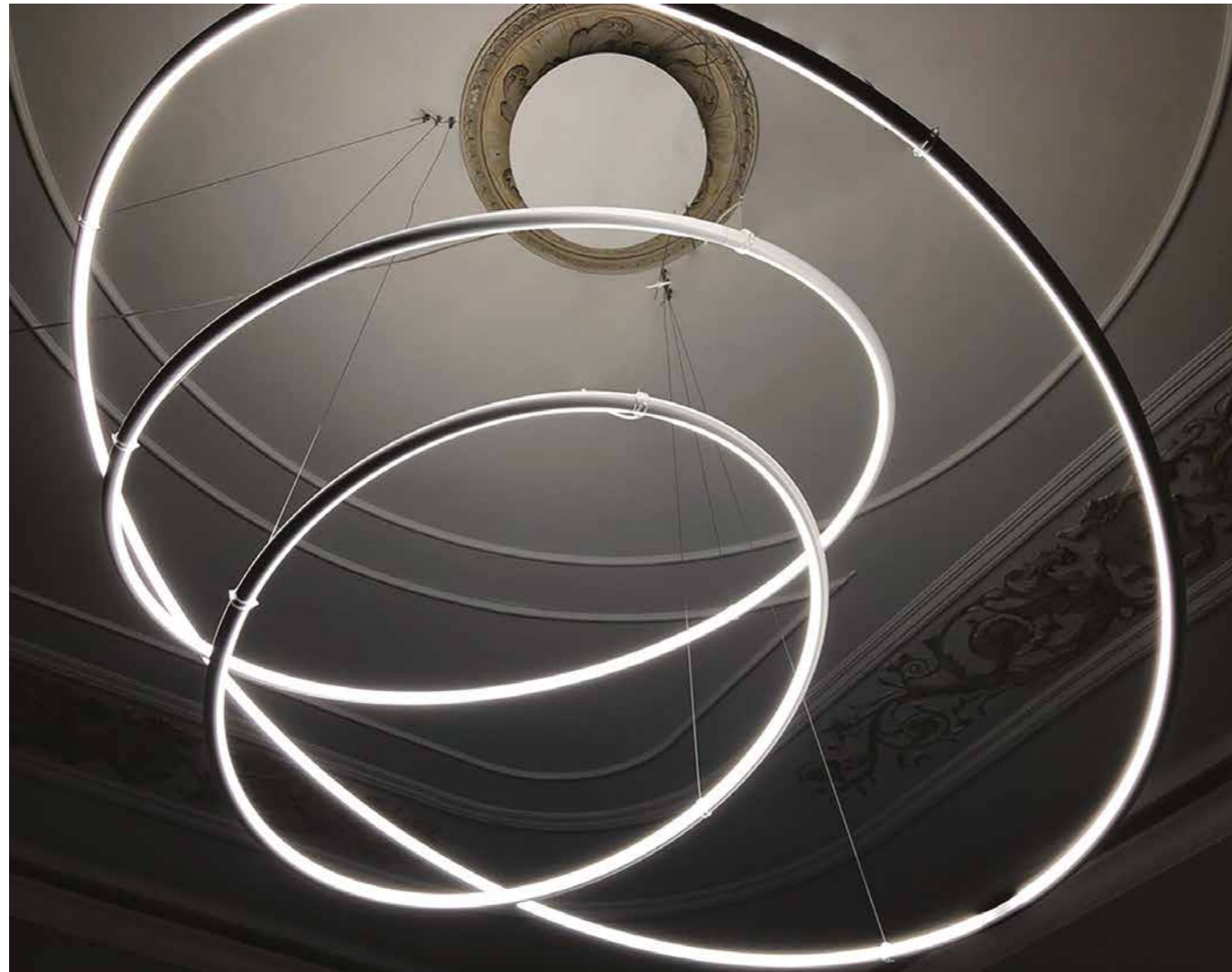



## Lancia Tonda System

Design P. Peperè



# Lancia Tonda System

Design P. Peperè



Length of electrical cable 98.42"  
Longitud del cable eléctrico 98.42"

## SINGLE LAMP CABLE KIT / KIT DE CABLE DE LÁMPARA INDIVIDUAL

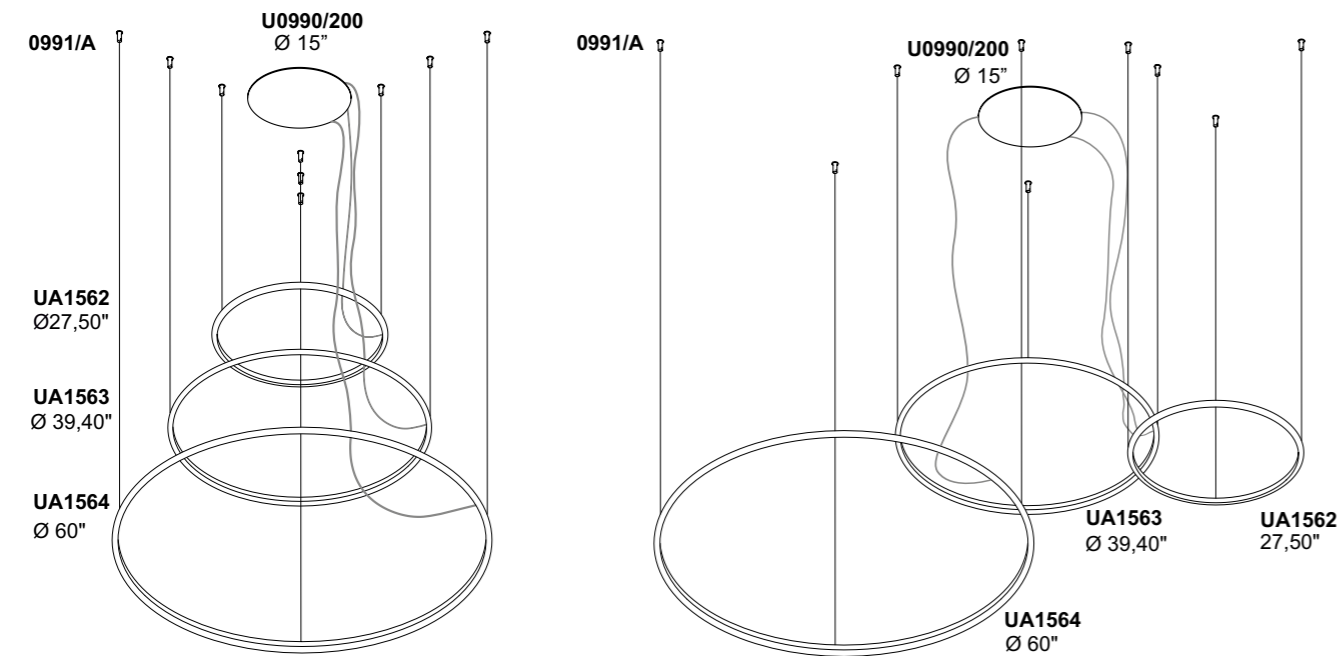

## 3 LAMPS CABLE KIT / JUEGO DE CABLES DE 3 LÁMPARAS

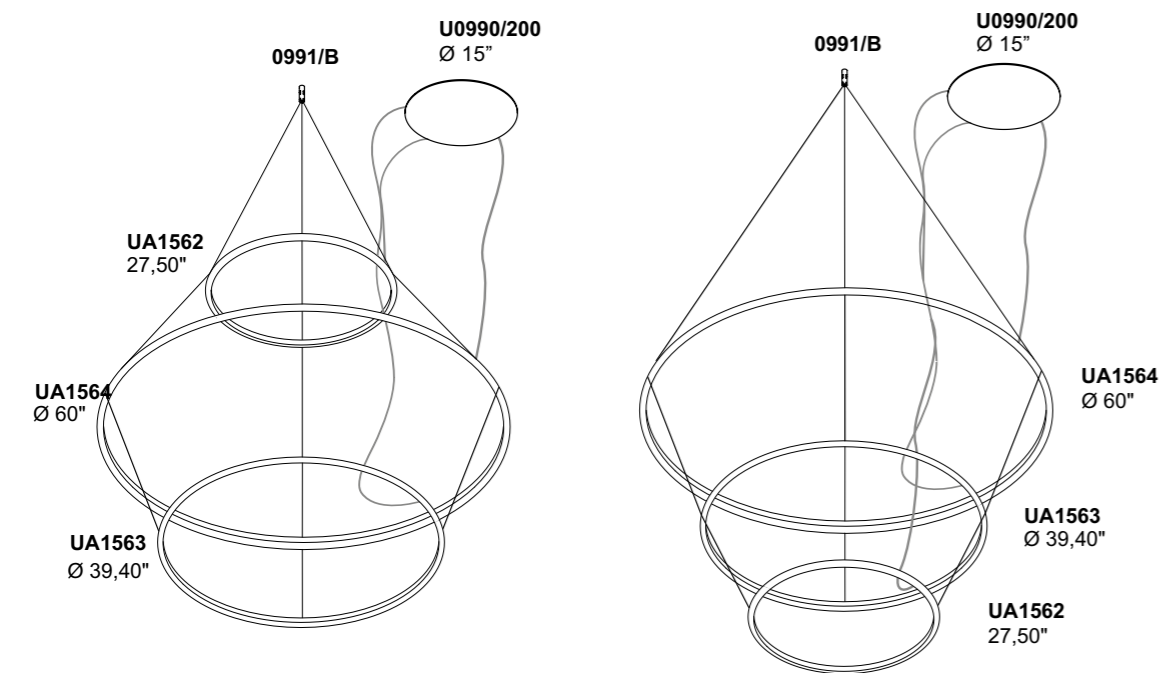

**0991/A**  
Single lamp cable kit  
Kit de cable de lámpara individual  
3 Steel cables 78.74"  
3 Cable retainers.  
3 Lamp Holder Clips  
3 Cables de acero de 78.74"  
3 Retenedores de cables.  
3 clips portalámparas

**0991/B**  
Single lamp cable kit  
Kit de cable de lámpara individual  
3 Steel cables 157.48"  
1 Displacement element for cable fixing.  
3 Lamp Holder Clips  
3 Cables de acero de 157.48"  
1 decentrador de cables.  
3 clips portalámparas

## CUSTOM SIZE

Ø	watt	codice - code	finiture - finishes	2700K	lm	3000K	lm	4000K	lm
19.69"	27W	UA1566	.01 White - Blanco	/XW	2835	/WW	3030	/W	3390
19.69"	27W	UA1566	.02 Black - Negro	/XW	2835	/WW	3030	/W	3390
19.69"	27W	UA1566	.25 Golded satin - Oro satinado	/XW	2835	/WW	3030	/W	3390
19.69"	27W	UA1566	.31 Chromed - Cromado	/XW	2835	/WW	3030	/W	3390
19.69"	27W	UA1566	.85 Painted silver finishing - Plata pintada	/XW	2835	/WW	3030	/W	3390
19.69"	27W	UA1566	.86 Painted gold finishing - Oro pintado	/XW	2835	/WW	3030	/W	3390
19.69"	27W	UA1566	.87 Painted copper finishing - Cobre pintado	/XW	2835	/WW	3030	/W	3390
19.69"	27W	UA1566	.88 Painted bronze finishing - Bronce pintado	/XW	2835	/WW	3030	/W	3390
27.56"	37.8W	UA1562	.01 White - Blanco	/XW	3969	/WW	4242	/W	4746
27.56"	37.8W	UA1562	.02 Black - Negro	/XW	3969	/WW	4242	/W	4746
27.56"	37.8W	UA1562	.25 Golded satin - Oro satinado	/XW	3969	/WW	4242	/W	4746
27.56"	37.8W	UA1562	.31 Chromed - Cromado	/XW	3969	/WW	4242	/W	4746
27.56"	37.8W	UA1562	.85 Painted silver finishing - Plata pintada	/XW	3969	/WW	4242	/W	4746
27.56"	37.8W	UA1562	.86 Painted gold finishing - Oro pintado	/XW	3969	/WW	4242	/W	4746
27.56"	37.8W	UA1562	.87 Painted copper finishing - Cobre pintado	/XW	3969	/WW	4242	/W	4746
27.56"	37.8W	UA1562	.88 Painted bronze finishing - Bronce pintado	/XW	3969	/WW	4242	/W	4746
39.37"	54W	UA1563	.01 White - Blanco	/XW	5670	/WW	6060	/W	6780
39.37"	54W	UA1563	.02 Black - Negro	/XW	5670	/WW	6060	/W	6780
39.37"	54W	UA1563	.85 Painted silver finishing - Plata pintada	/XW	5670	/WW	6060	/W	6780
39.37"	54W	UA1563	.86 Painted gold finishing - Oro pintado	/XW	5670	/WW	6060	/W	6780
39.37"	54W	UA1563	.87 Painted copper finishing - Cobre pintado	/XW	5670	/WW	6060	/W	6780
39.37"	54W	UA1563	.88 Painted bronze finishing - Bronce pintado	/XW	5670	/WW	6060	/W	6780
59.06"	81W	UA1564	.01 White - Blanco	/XW	8505	/WW	9090	/W	10170
59.06"	81W	UA1564	.02 Black - Negro	/XW	8505	/WW	9090	/W	10170
59.06"	81W	UA1564	.85 Painted silver finishing - Plata pintada	/XW	8505	/WW	9090	/W	10170
59.06"	81W	UA1564	.86 Painted gold finishing - Oro pintado	/XW	8505	/WW	9090	/W	10170
59.06"	81W	UA1564	.87 Painted copper finishing - Cobre pintado	/XW	8505	/WW	9090	/W	10170
59.06"	81W	UA1564	.88 Painted bronze finishing - Bronce pintado	/XW	8505	/WW	9090	/W	10170

Suspension fixing kit and ceiling canopies, power supplies separately ordered  
El kit de montaje en suspensión y las rosetas con fuentes de alimentación deben pedirse por separado

## FINISHES CODES - CÓDIGOS DE ACABADOS

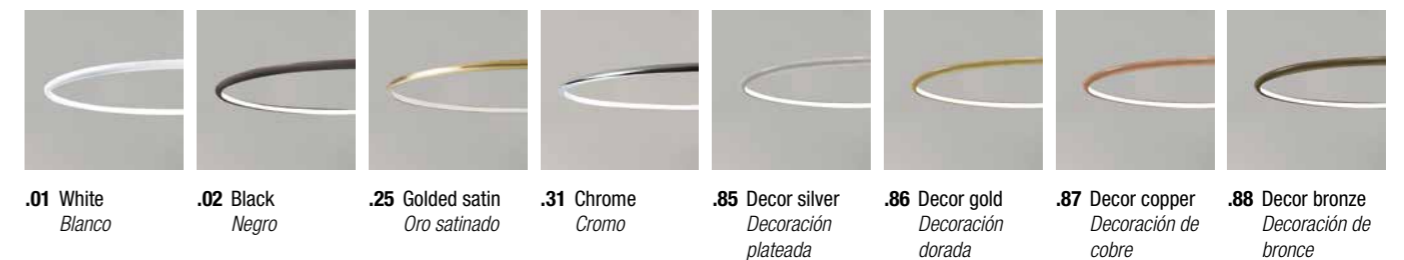

# Lancia Tonda System

Design P. Pepere



CEILING ROSES FOR SUSPENSION SYSTEMS 24V / ROSETAS PARA SISTEMAS DE SUSPENSIÓN DE 24V

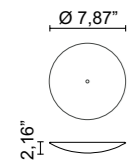

Canopy complete with 60W driver  
Rosetón completa con controlador de 60W

U0990/60 . _ _	1.32 lb
.01  White - Blanco	60 W
.02  Black - Negro	60 W
.85  Painted silver finishing - Plata pintada	60 W
.86  Painted gold finishing - Oro pintado	60 W
.87  Painted copper finishing - Cobre pintado	60 W
.88  Painted bronze finishing - Bronce pintado	60 W

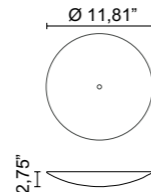

Canopy complete with 99W driver  
Rosetón completa con controlador de 99W

U0990/100 . _ _ / _ _	2.87 lb
.01  White - Blanco	99 W
.02  Black - Negro	99 W
.85  Painted silver finishing - Plata pintada	99 W
.86  Painted gold finishing - Oro pintado	99 W
.87  Painted copper finishing - Cobre pintado	99 W
.88  Painted bronze finishing - Bronce pintado	99 W

/P DIMMER		MAX 75W
/V DIMMER		MAX 75W
/D DIMMER		MAX 75W

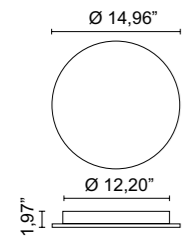

Canopy complete with driver 198W  
Roseta completa con driver de 198W

U0990/200 . _ _ / _ _	4.41 lb
.01  White - Blanco	198 W
.02  Black - Negro	198 W
.85  Painted silver finishing - Plata pintada	198 W
.86  Painted gold finishing - Oro pintado	198 W
.87  Painted copper finishing - Cobre pintado	198 W
.88  Painted bronze finishing - Bronce pintado	198 W

/P DIMMER		MAX 2x75W
/V DIMMER		MAX 2x75W
/D DIMMER		MAX 2x75W





# Lancia Tonda

Design P. Peperè



# Lancia Tonda

Design P. Pepere



With push dimm on cable  
Completo de cable Push dimm

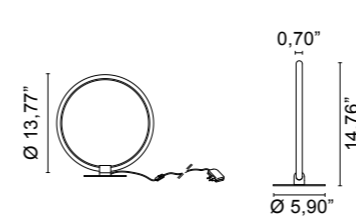

**U2513**... / ... 1.54 lb

- .01**  White - Blanco
- .02**  Black - Negro
- .25**  Golded satin - Oro satinado
- .31**  Chromed - Cromado

<b>/W</b>	4000K	LED 9,6W CRI>90	1080lm
<b>/WW</b>	3000K	LED 9,6W CRI>90	1020lm
<b>/XW</b>	2700K	LED 9,6W CRI>90	960lm

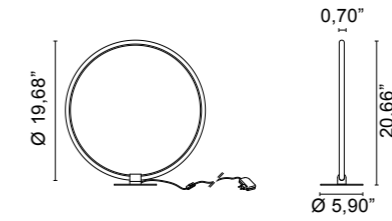

**U2514**... / ... 2.20 lb

- .01**  White - Blanco
- .02**  Black - Negro
- .25**  Golded satin - Oro satinado
- .31**  Chromed - Cromado

<b>/W</b>	4000K	LED 14W CRI>90	1620lm
<b>/WW</b>	3000K	LED 14W CRI>90	1530lm
<b>/XW</b>	2700K	LED 14W CRI>90	1440lm



## FINISHES CODES - CÓDIGOS DE ACABADOS



- .01** White  
Blanco
- .02** Black  
Negro
- .25** Golded satin  
Oro satinado
- .31** Chrome  
Cromo

# Lancia Tonda

Design P. Pepere



With push dimm on cable  
Completo de cable Push dimm

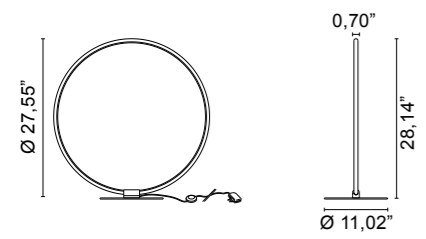

**U3513.** / / 4.41 lb

- .01** White - Blanco
- .02** Black - Negro
- .25** Golded satin - Oro satinado
- .31** Chromed - Cromado

<b>/W</b>	4000K	LED 20W CRI>90	2268lm
<b>/WW</b>	3000K	LED 20W CRI>90	2142lm
<b>/XW</b>	2700K	LED 20W CRI>90	2016lm

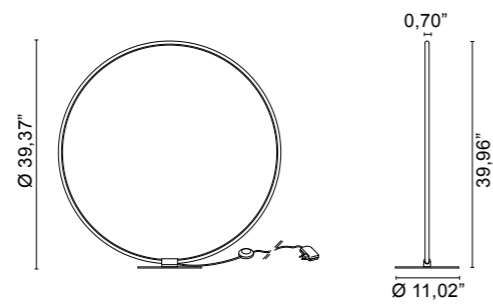

**U3514.** / / 8.60 lb

- .01** White - Blanco
- .02** Black - Negro

<b>/W</b>	4000K	LED 29W CRI>90	3240lm
<b>/WW</b>	3000K	LED 29W CRI>90	3060lm
<b>/XW</b>	2700K	LED 29W CRI>90	2880lm

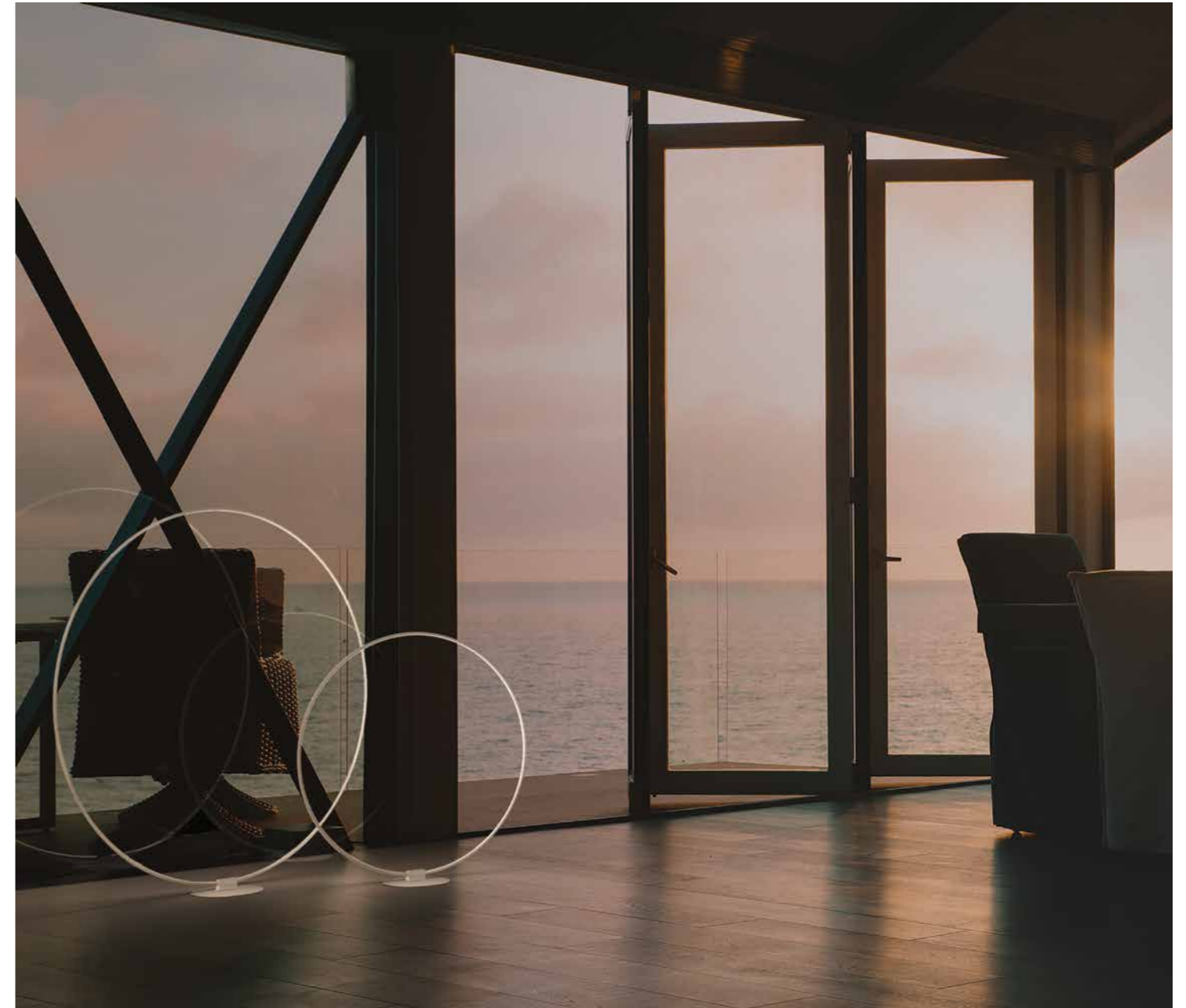

## FINISHES CODES - CÓDIGOS DE ACABADOS

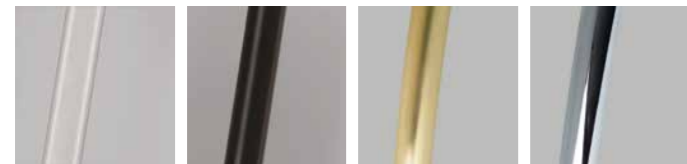

- .01** White  
Blanco
- .02** Black  
Negro
- .25** Golded satin  
Oro satinado
- .31** Chrome  
Cromo

# Lancia

Design P. Peperè

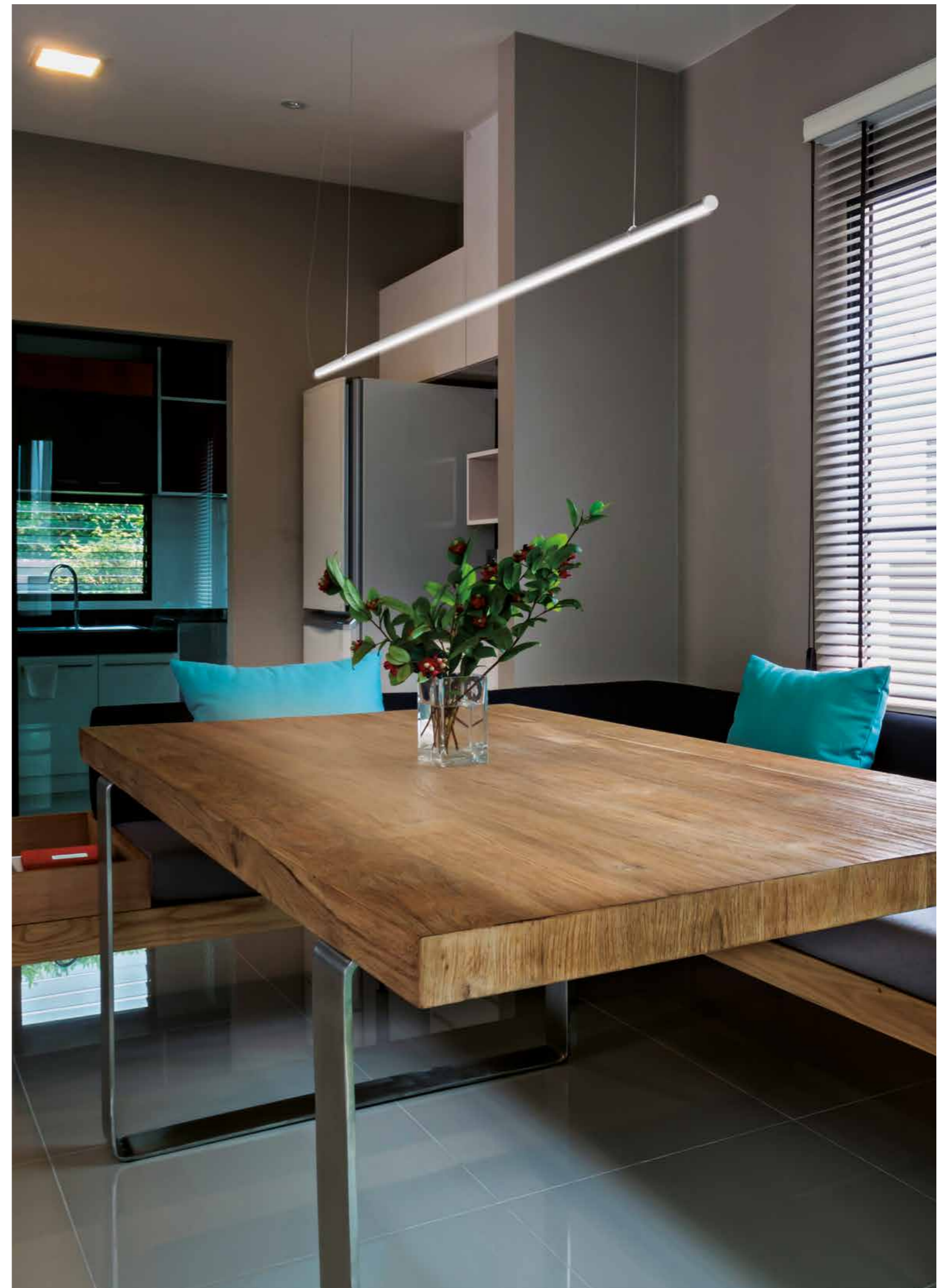

# Lancia

Design P. Pepere

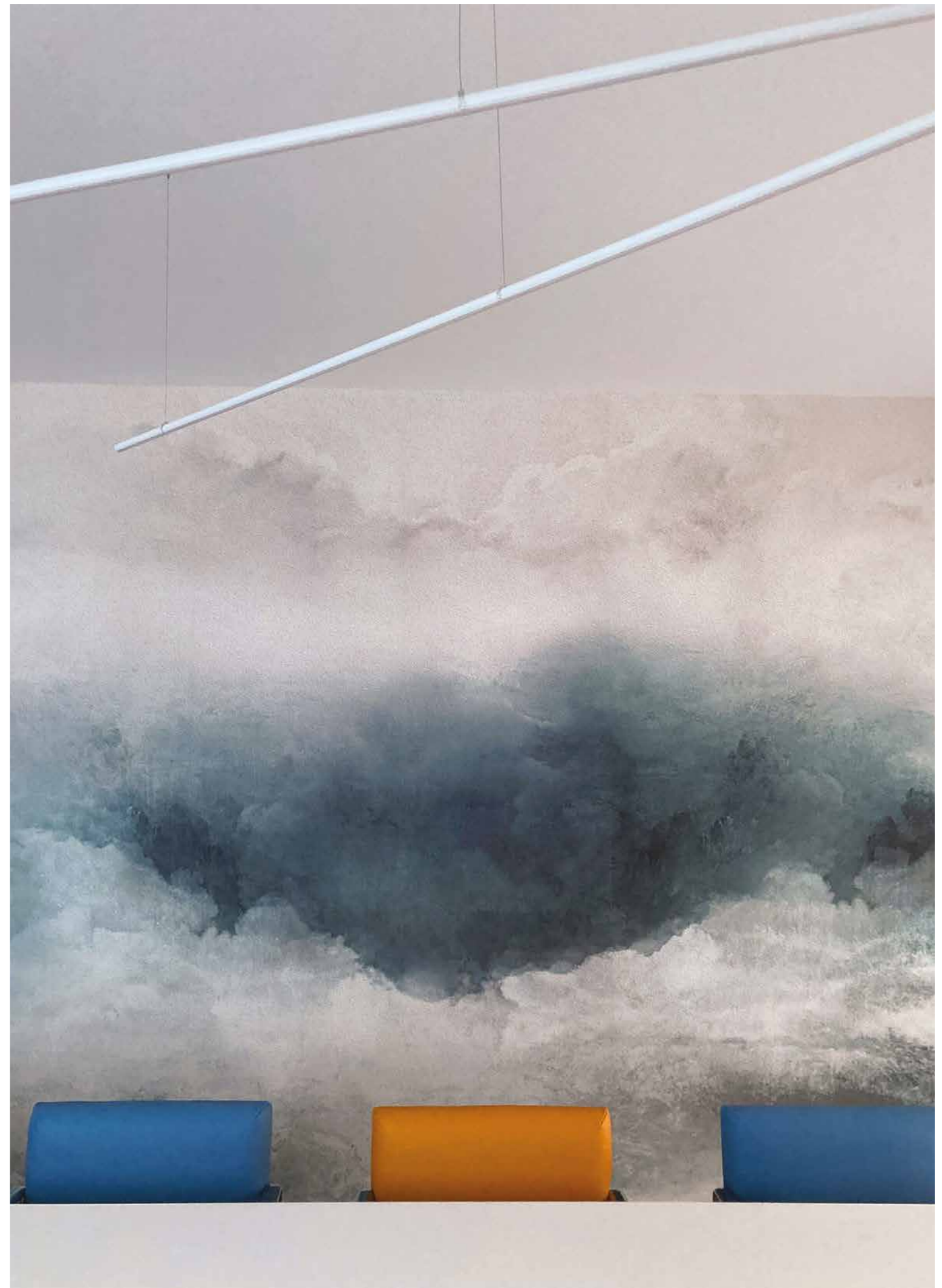
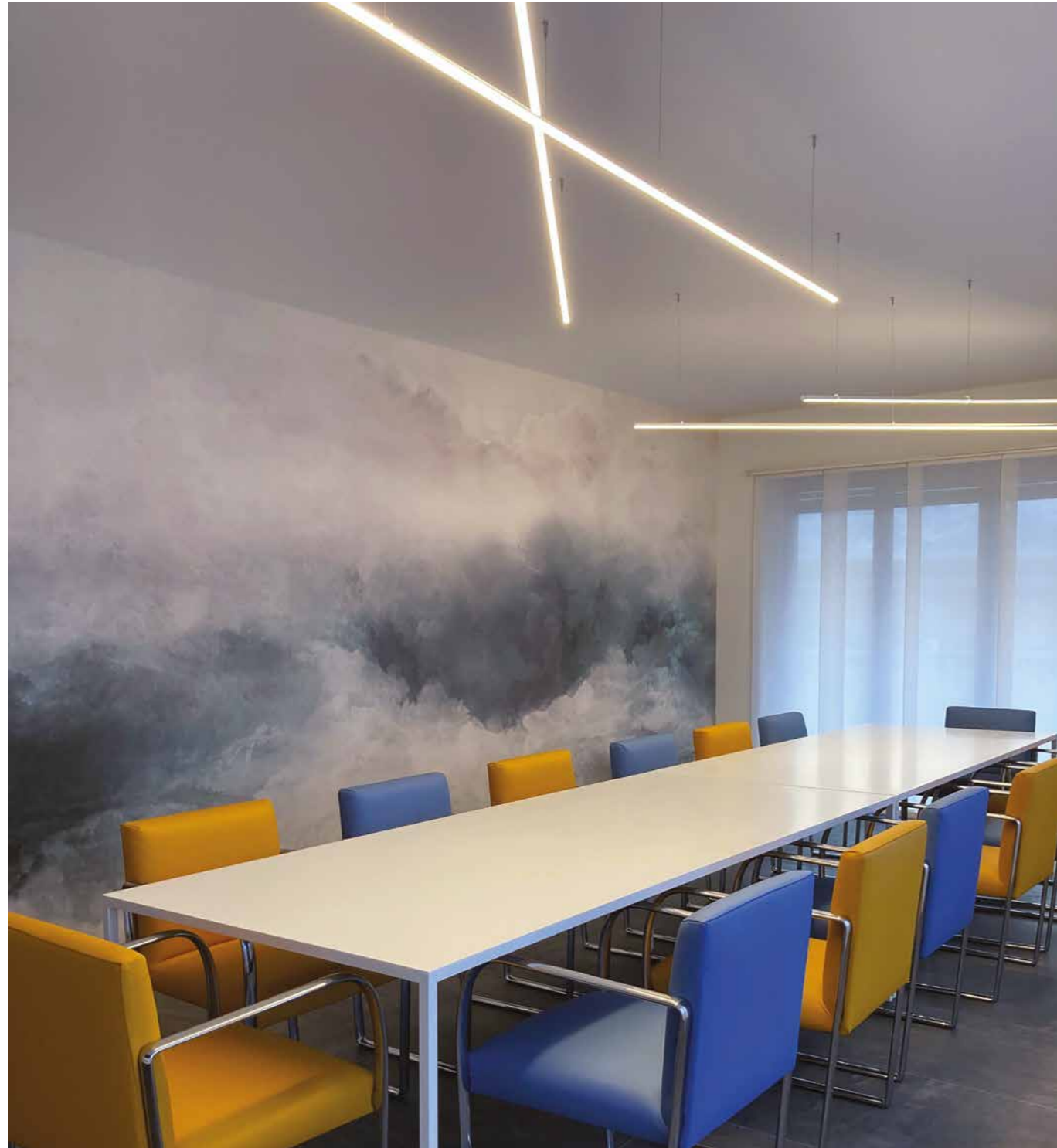



## Lancia

Design P. Pepere

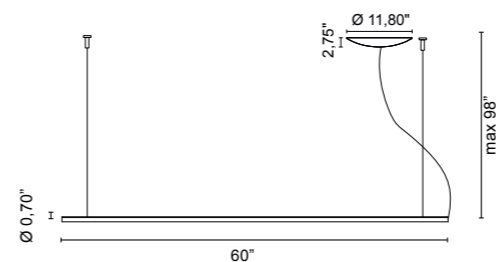

**U1540.** \_ / \_ \_ 2.43 lb

- .01**  White - Blanco
- .02**  Black - Negro
- .85**  Painted silver finishing - Plata pintada
- .86**  Painted gold finishing - Oro pintado
- .87**  Painted copper finishing - Cobre pintado
- .88**  Painted bronze finishing - Bronce pintado

<b>/W</b>	4000K	LED 27W CRI>90	3390lm
<b>/WW</b>	3000K	LED 27W CRI>90	3030lm
<b>/XW</b>	2700K	LED 27W CRI>90	2835lm



### CUSTOM SIZE

Table of available lengths on request.  
Tabla de longitudes disponible previa solicitud.

inches	watt	2700K (XW)	lm	3000K (WW)	lm	4000K (W)	lm
40.16"	18W	U1540.01/100/XW	1890	U1540.01/100/WW	2020	U1540.01/100/W	2260
50.00"	22.5W	U1540.01/125/XW	2362	U1540.01/125/WW	2525	U1540.01/125/W	2825
59.84"	27W	U1540.01/150/XW	2835	U1540.01/150/WW	3030	U1540.01/150/W	3390
69.69"	31.5W	U1540.01/175/XW	3307	U1540.01/175/WW	3535	U1540.01/175/W	3955
79.53"	36W	U1540.01/200/XW	3780	U1540.01/200/WW	4040	U1540.01/200/W	4520
89.37"	40.5W	U1540.01/225/XW	4252	U1540.01/225/WW	4545	U1540.01/225/W	5085
99.21"	45W	U1540.01/250/XW	4725	U1540.01/250/WW	5050	U1540.01/250/W	5650

### FINISHES CODES - CÓDIGOS DE ACABADOS



- .01** White  
Blanco
- .02** Black  
Negro
- .85** Painted silver  
finishing  
Plata pintada
- .86** Painted gold  
finishing  
Oro pintado
- .87** Painted copper  
finishing  
Cobre pintado
- .88** Painted bronze  
finishing  
Bronce pintado

# Lancia System

Design P. Pepere



## CUSTOM SIZE

Table of available lengths on request.  
Tabla de longitudes disponible previa solicitud.

inches	watt	2700K (XW)	lm	3000K (WW)	lm	4000K (W)	lm
40.16"	18W	UA1539.01/100/XW	1890	UA1539.01/100/WW	2020	UA1539.01/100/W	2260
50.00"	22.5W	UA1539.01/125/XW	2362	UA1539.01/125/WW	2525	UA1539.01/125/W	2825
59.84"	27W	UA1539.01/XW *	2835	UA1539.01/WW *	3030	UA1539.01/W *	3390
69.69"	31.5W	UA1539.01/175/XW	3307	UA1539.01/175/WW	3535	UA1539.01/175/W	3955
79.53"	36W	UA1539.01/200/XW	3780	UA1539.01/200/WW	4040	UA1539.01/200/W	4520
89.37"	40.5W	UA1539.01/225/XW	4252	UA1539.01/225/WW	4545	UA1539.01/225/W	5085
99.21"	45W	UA1539.01/250/XW	4725	UA1539.01/250/WW	5050	UA1539.01/250/W	5650

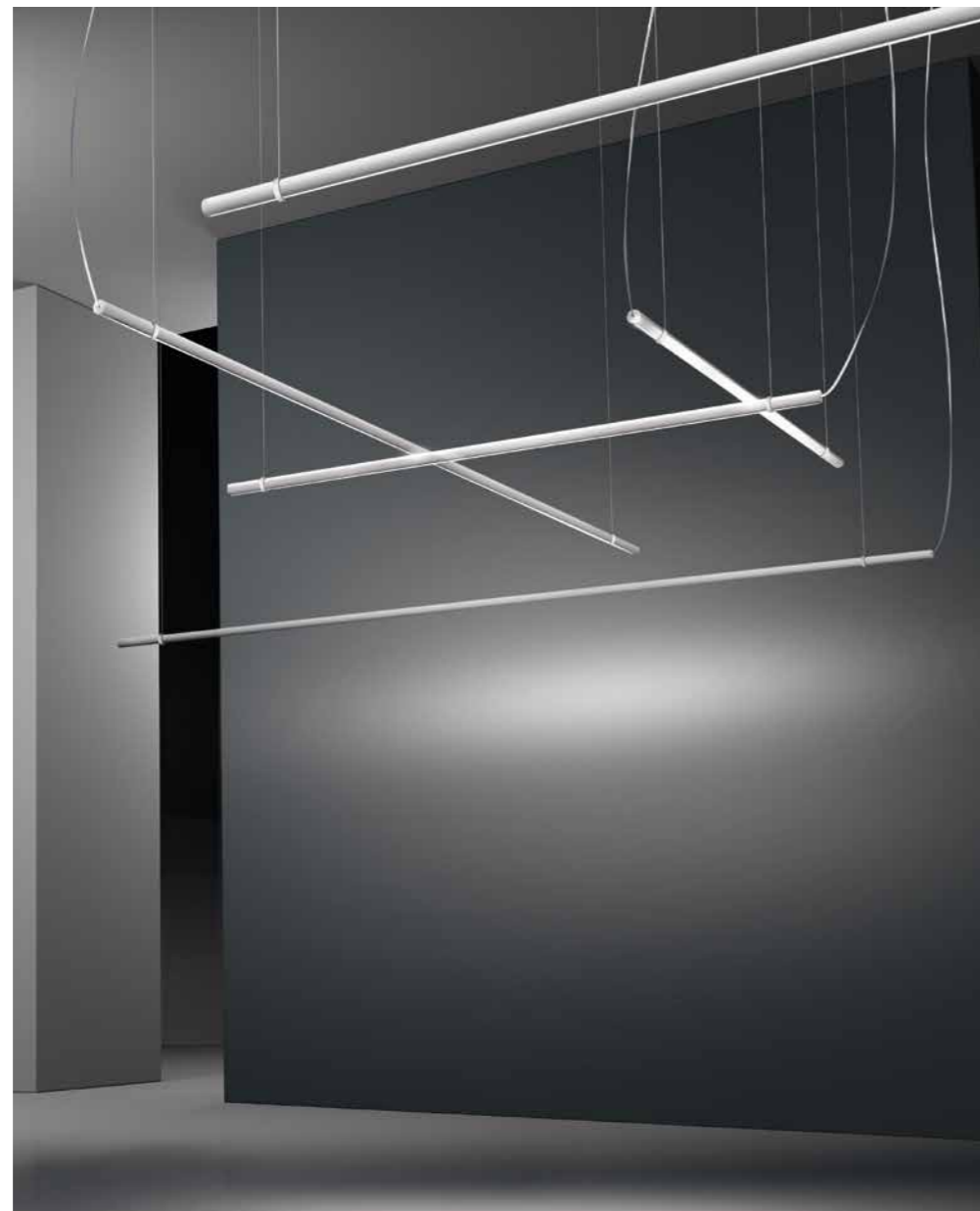
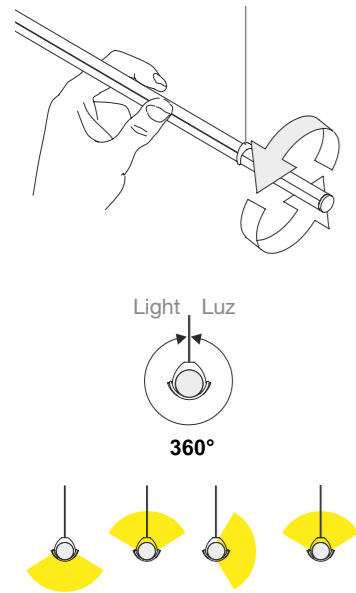

## CEILING ROSES FOR SUSPENSION SYSTEMS 24V / ROSETAS PARA SISTEMAS DE SUSPENSIÓN DE 24V

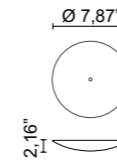

Canopy complete with 60W driver  
Rosetón completa con controlador de 60W

U0990/60 . _ _	1.32 lb
.01 White - Blanco	60 W
.02 Black - Negro	60 W
.85 Painted silver finishing - Plata pintada	60 W
.86 Painted gold finishing - Oro pintado	60 W
.87 Painted copper finishing - Cobre pintado	60 W
.88 Painted bronze finishing - Bronce pintado	60 W

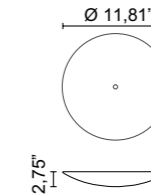

Canopy complete with 99W driver  
Rosetón completa con controlador de 99W

U0990/100 . _ _ / _ _	2.87 lb
.01 White - Blanco	99 W
.02 Black - Negro	99 W
.85 Painted silver finishing - Plata pintada	99 W
.86 Painted gold finishing - Oro pintado	99 W
.87 Painted copper finishing - Cobre pintado	99 W
.88 Painted bronze finishing - Bronce pintado	99 W

/P DIMMER		MAX 75W
/V DIMMER		MAX 75W
/D DIMMER		MAX 75W

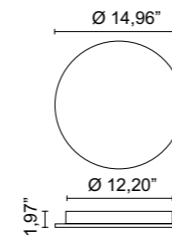

Canopy complete with driver 198W  
Roseta completa con driver de 198W

U0990/200 . _ _ / _ _	4.41 lb
.01 White - Blanco	198 W
.02 Black - Negro	198 W
.85 Painted silver finishing - Plata pintada	198 W
.86 Painted gold finishing - Oro pintado	198 W
.87 Painted copper finishing - Cobre pintado	198 W
.88 Painted bronze finishing - Bronce pintado	198 W

/P DIMMER		MAX 2x75W
/V DIMMER		MAX 2x75W
/D DIMMER		MAX 2x75W



# Lancia System

Design P. Pepere

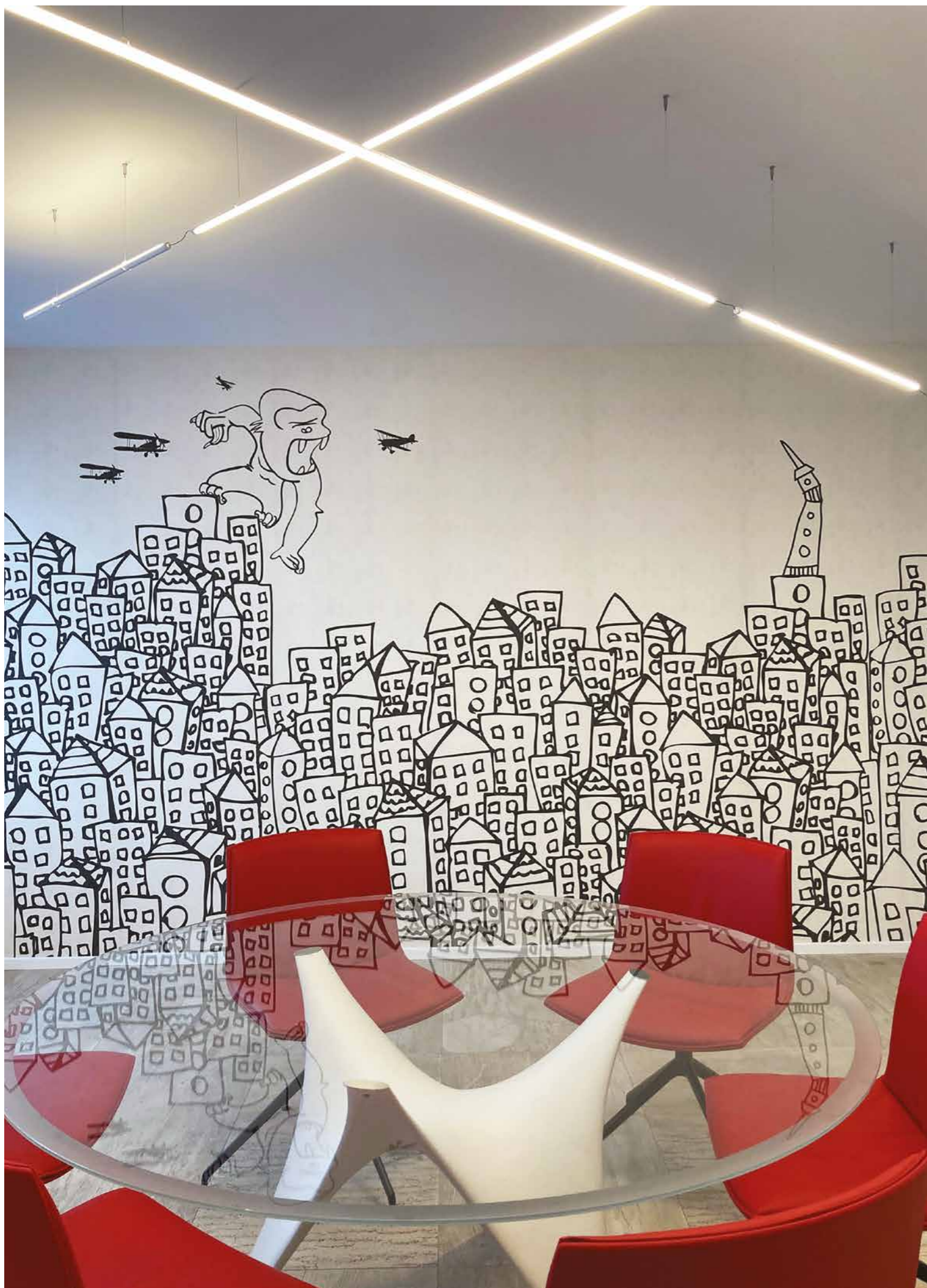



# Lancia no limits

Design Lux Studio



# Lancia no limits

Design Lux Studio



Without canopy/driver  
Sin roseta/conductor

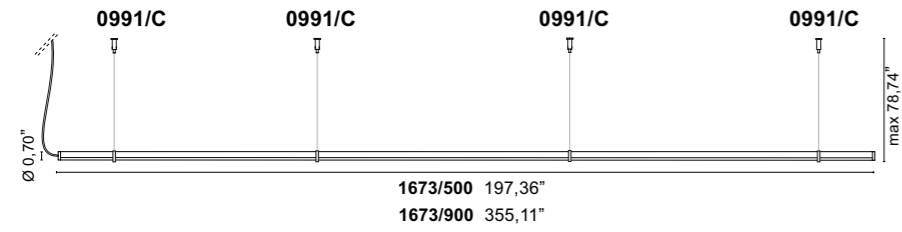

Suspension fixing kit and ceiling canopies, power supplies separately ordered  
El kit de montaje en suspensión y las rosetas con fuentes de alimentación deben pedirse por separado

U1673._ _ / 500 / _			U1673._ _ / 900 / _				
9.26 lb			13.89 lb				
.01	White - Blanco		.01	White - Blanco			
.02	Black - Negro		.02	Black - Negro			
/W	4000K	LED 60W CRI>90	9200lm	/W	4000K	LED 108W CRI>90	16560lm
/WW	3000K	LED 60W CRI>90	8250lm	/WW	3000K	LED 108W CRI>90	14850lm
/XW	2700K	LED 60W CRI>90	7800lm	/XW	2700K	LED 108W CRI>90	14040lm



## ACCESSORIES ACCESORIOS



Single lamp cable kit  
1 Steel cable 78,74"  
1 Element for cable fixing  
1 Suspension clip  
Kit de cable de lámpara individual  
1 Cable de acero de 78,74"  
1 Desenroscador para fijación de cables  
1 Pinza portalámparas



Ceiling fixing clip  
Clips de fijación al techo

0991/C

0093

## FINISHES CODES - CÓDIGOS DE ACABADOS

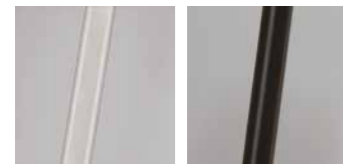

.01 White  
Blanco

.02 Black  
Negro



# Lancia no limits

Design Lux Studio



## CEILING ROSES FOR SUSPENSION SYSTEMS 24V / ROSETAS PARA SISTEMAS DE SUSPENSIÓN DE 24V

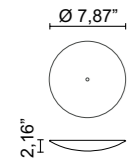

Canopy complete with 60W driver  
Rosetón completa con controlador de 60W

U0990/60 . _ _	Weight
.01 White - Blanco	60 W
.02 Black - Negro	60 W
.85 Painted silver finishing - Plata pintada	60 W
.86 Painted gold finishing - Oro pintado	60 W
.87 Painted copper finishing - Cobre pintado	60 W
.88 Painted bronze finishing - Bronce pintado	60 W

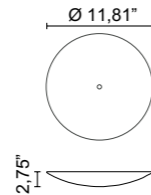

Canopy complete with 99W driver  
Rosetón completa con controlador de 99W

U0990/100 . _ _ / _ _	Weight
.01 White - Blanco	99 W
.02 Black - Negro	99 W
.85 Painted silver finishing - Plata pintada	99 W
.86 Painted gold finishing - Oro pintado	99 W
.87 Painted copper finishing - Cobre pintado	99 W
.88 Painted bronze finishing - Bronce pintado	99 W

/P DIMMER		MAX 75W
/V DIMMER		MAX 75W
/D DIMMER		MAX 75W

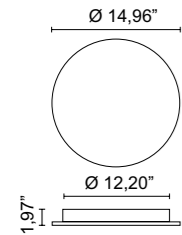

Canopy complete with driver 198W  
Roseta completa con driver de 198W

U0990/200 . _ _ / _ _	Weight
.01 White - Blanco	198 W
.02 Black - Negro	198 W
.85 Painted silver finishing - Plata pintada	198 W
.86 Painted gold finishing - Oro pintado	198 W
.87 Painted copper finishing - Cobre pintado	198 W
.88 Painted bronze finishing - Bronce pintado	198 W

/P DIMMER		MAX 2x75W
/V DIMMER		MAX 2x75W
/D DIMMER		MAX 2x75W

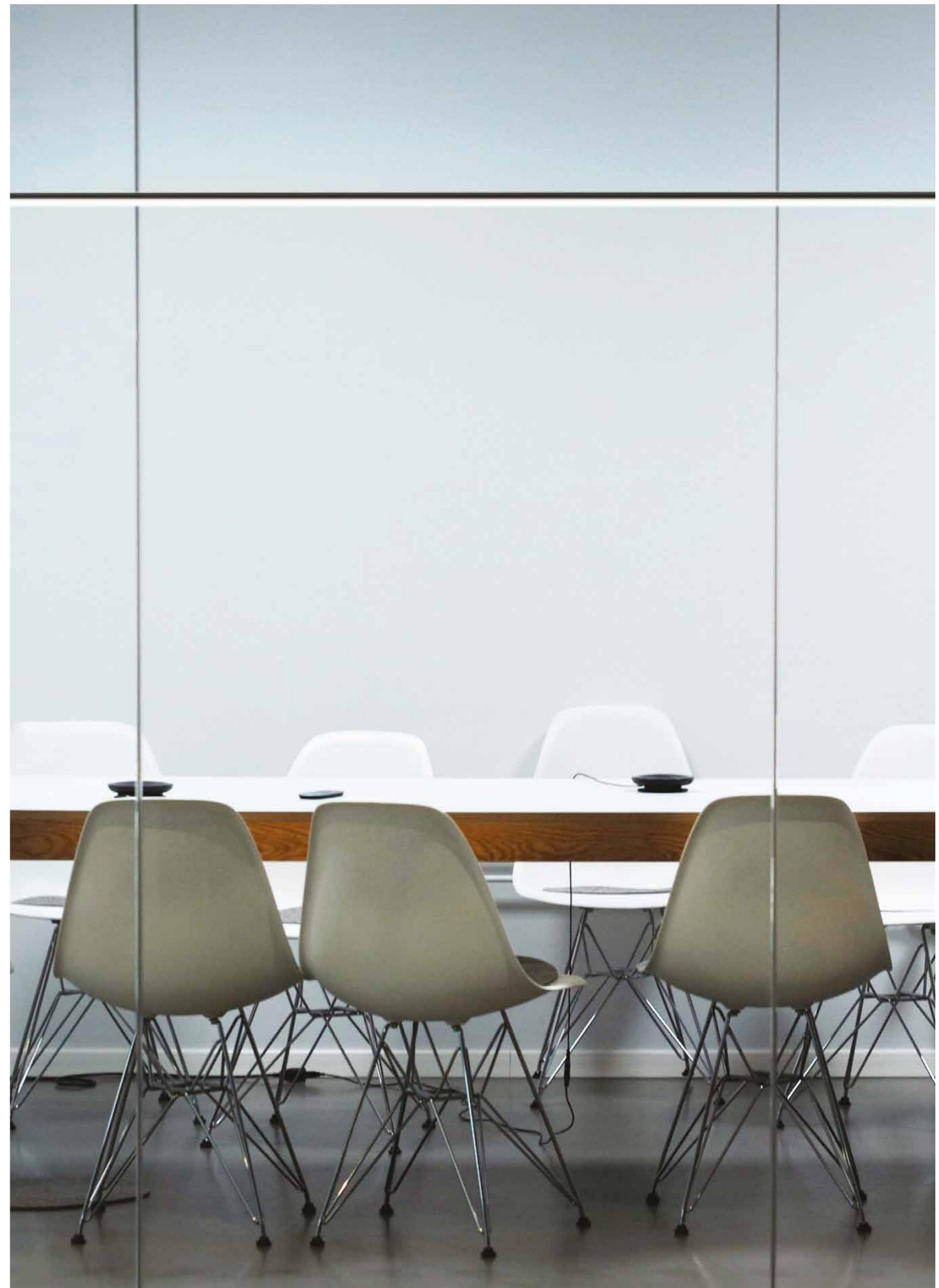

# Lancia di Achille

Design P. Peperè

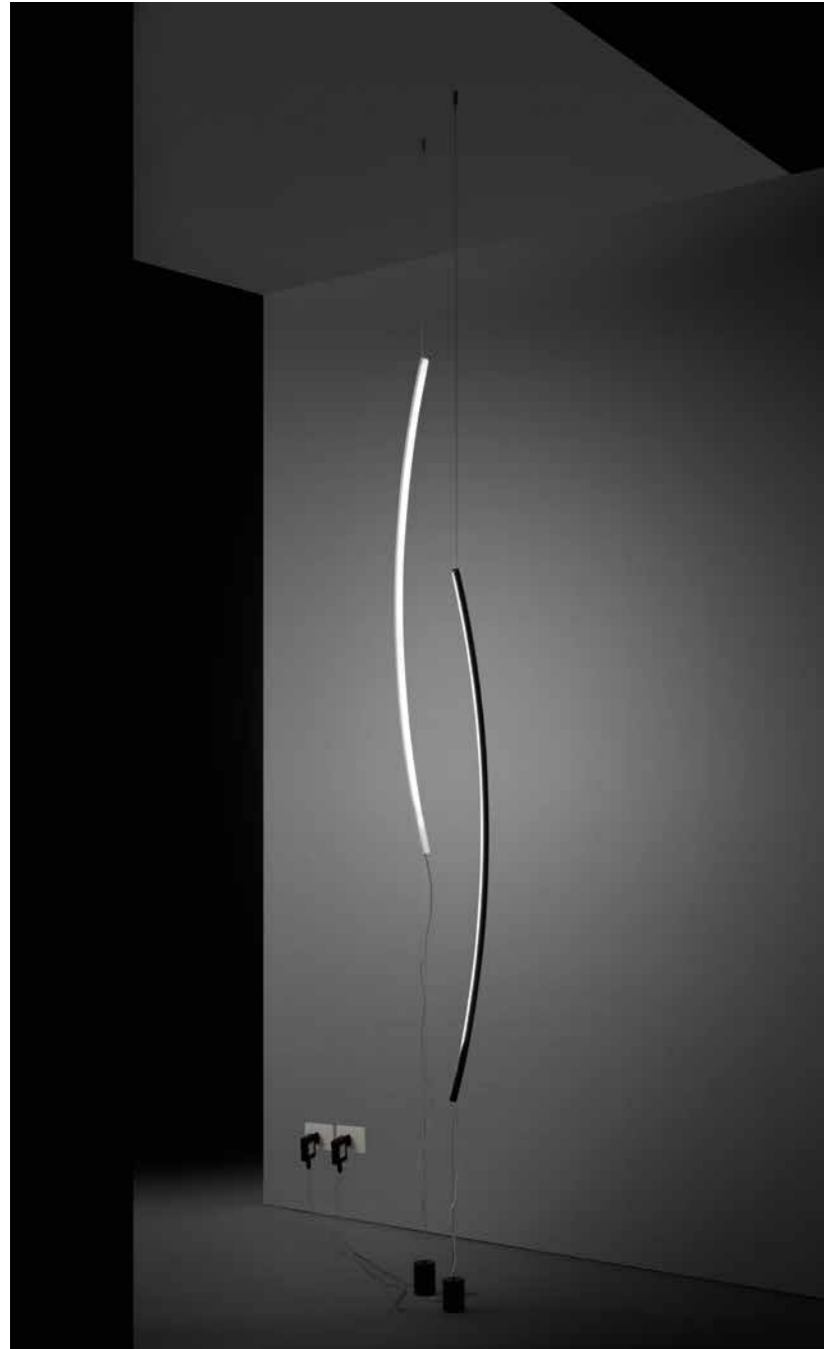

# Lancia di Achille

Design P. Peperè

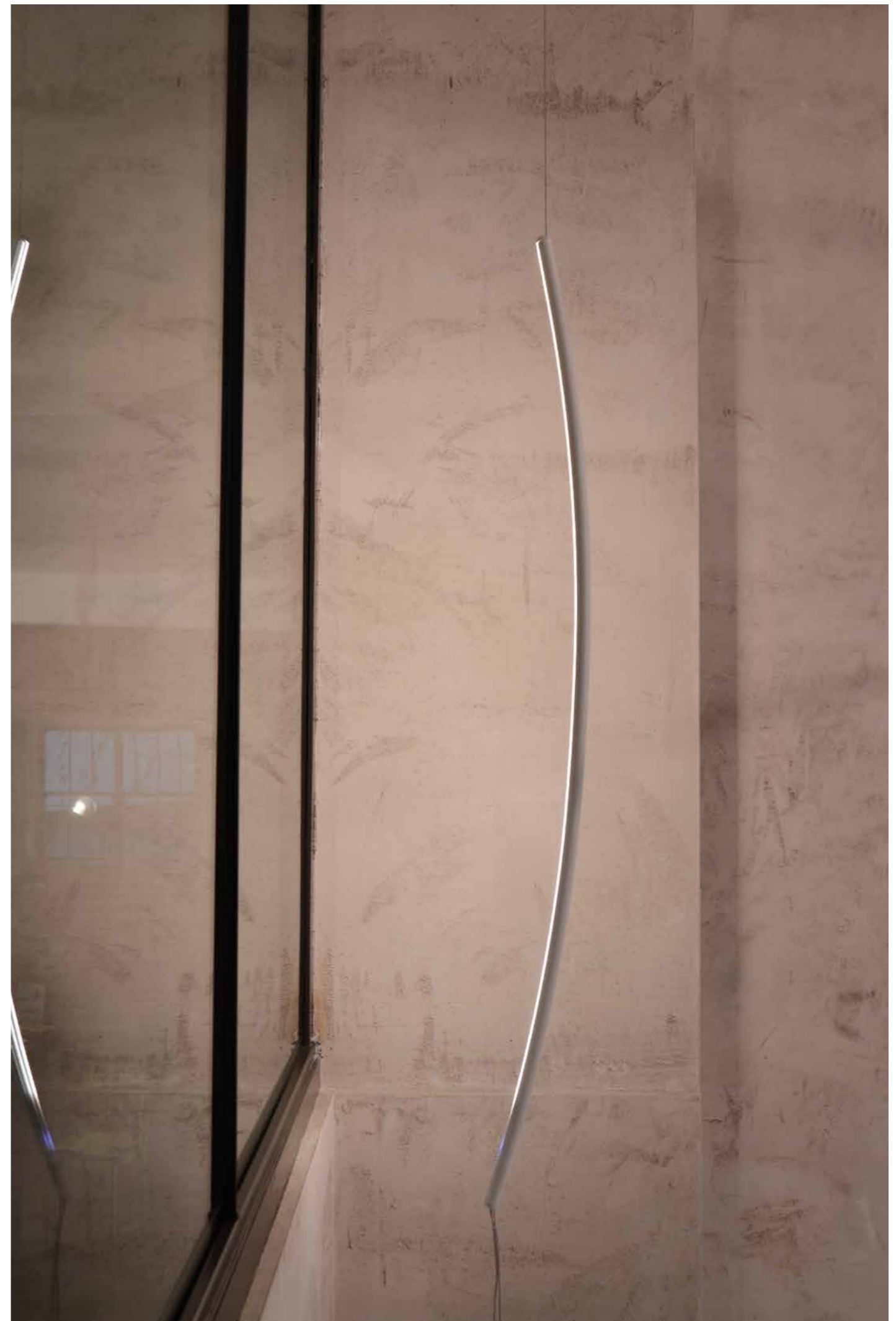

# Lancia di Achille

Design P. Peperè



Touch dimmer switch included  
Con regulador de intensidad táctil

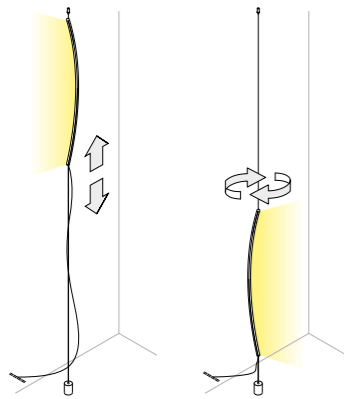
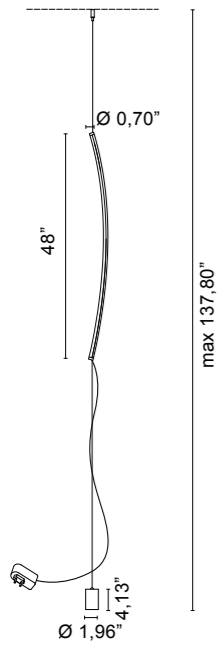

U1567... / ... 6.17 lb

.01 White - Blanco

.02 Black - Negro

.31 Chromed - Cromado



/W 4000K LED 19,5W CRI>90 2486lm

/WW 3000K LED 19,5W CRI>90 2222lm

/XW 2700K LED 19,5W CRI>90 2079lm

## FINISHES CODES - CÓDIGOS DE ACABADOS



.01 White  
Blanco

.02 Black  
Negro

.31 Chrome  
Cromo

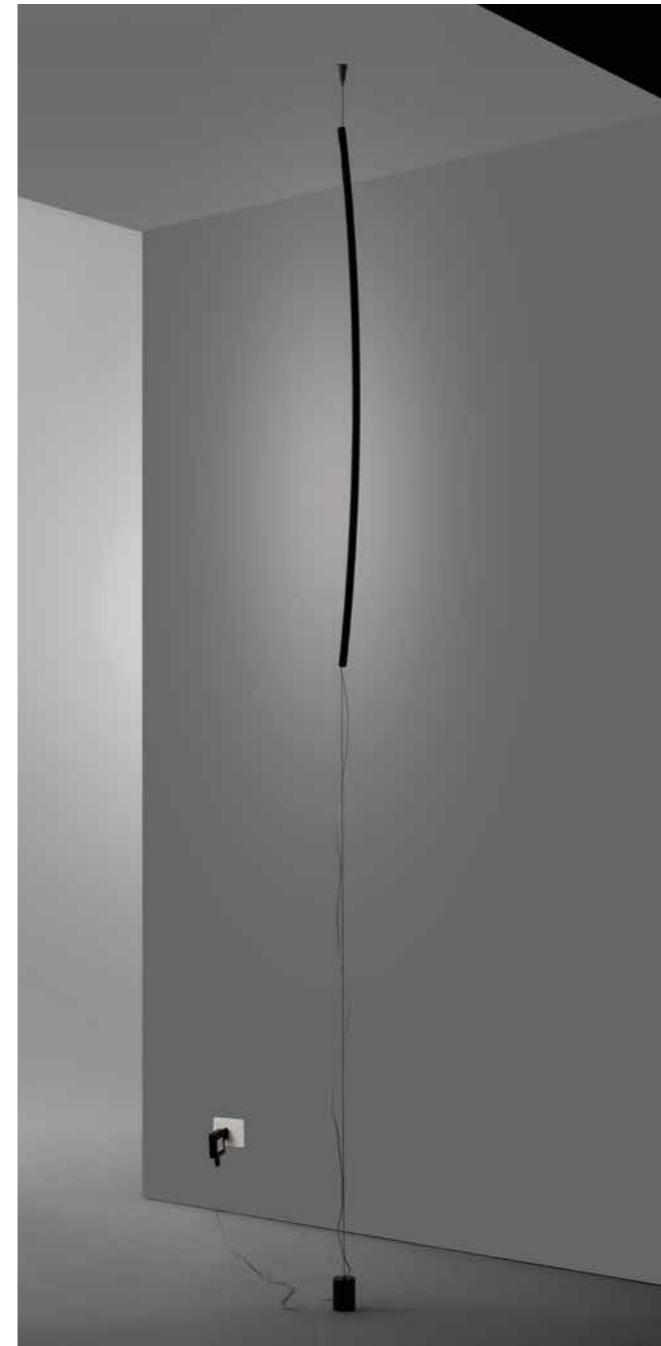

The dimmer-switch with memory is integrated in the stem.  
El regulador de intensidad táctil con memoria está integrado en el perfil.



The counterweight maintains the lamp in the desired position.  
El contrapeso permite colocar la lámpara en el lugar deseado.

INDOOR

# Matita

Design Mati



The Matita collection features a slender aluminium profile with a high-efficiency LED micro-circuit and is part of a family that contains suspension, table, ceiling, floor, and wall lamps. The uniqueness of the joints allows the profiles to move freely, creating light solutions that seem to cut the wall into two sections, capable of achieving up to two and a half meters in height that can redefine the space. The surprising result that Ego luce accomplished with Matita is the creation of design objects that are functional tools used to “draw with light” and redefine the environment.

*La colección Matita se caracteriza por un fino perfil de aluminio con un microcircuito LED de alta eficiencia y forma parte de una familia que incluye lámparas colgantes, de mesa, de pared, de pie y de sobremesa. La singularidad de las juntas permite que los perfiles se muevan libremente, creando soluciones de iluminación que parecen cortar la pared en dos secciones, capaces de alcanzar hasta dos metros y medio de altura y redefinir el espacio. El sorprendente resultado que Ego luce ha conseguido con Matita es la creación de objetos de diseño que son herramientas funcionales utilizadas para “dibujar con la luz” y redefinir el entorno.*

# Matita

Design Mati



## EXAMPLES OF MULTIPLE INSTALLATION EJEMPLOS DE INSTALACIÓN MÚLTIPLE

Examples of multiple installation, the choice of the ceiling rose depends on total power consumption.  
*Ejemplos de instalación múltiple, la elección de la roseta viene determinada por la suma de las potencias de las lámparas individuales.*

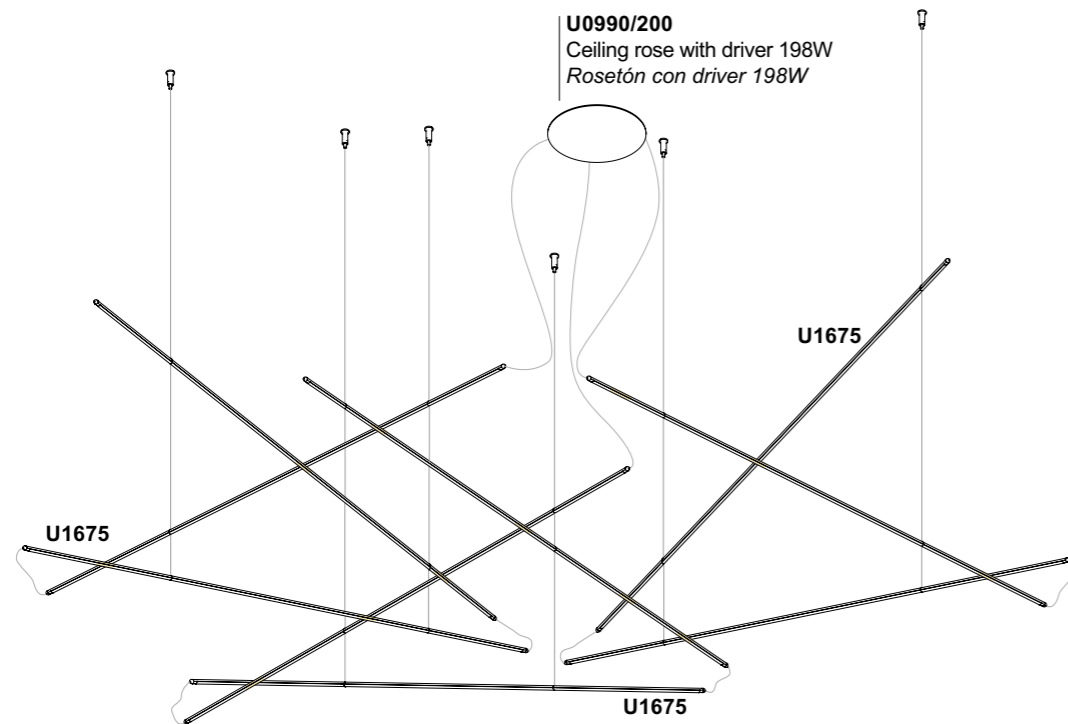
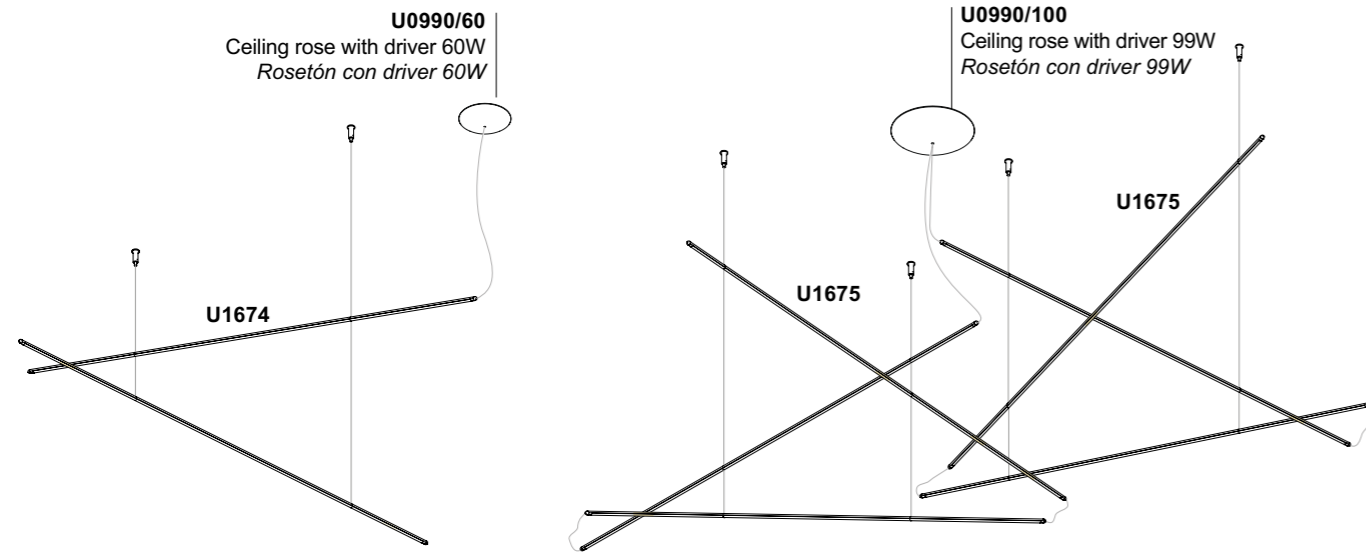





## Matita

Design Mati

Without canopy/driver  
 Sin roseta/conductor

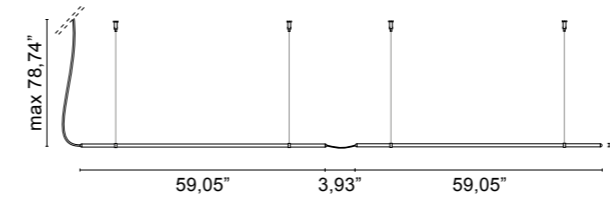

Suspension fixing kit supplied with the lamp  
 Kit de fijación de la suspensión suministrado con la lámpara

**U1674** \_ \_ / \_ \_ 1.10 lb

**.02** ■ Black - Negro

<b>/W</b>	LED 24V 37,5W	4440lm	4000K
<b>/WW</b>	LED 24V 37,5W	4050lm	3000K
<b>/XW</b>	LED 24V 37,5W	3600lm	2700K

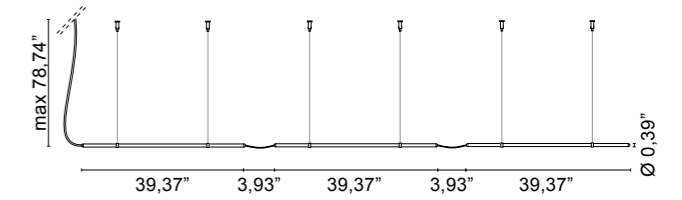

Suspension fixing kit supplied with the lamp  
 Kit de fijación de la suspensión suministrado con la lámpara

**U1675** \_ \_ / \_ \_ 1.32 lb

**.02** ■ Black - Negro

<b>/W</b>	LED 24V 37,5W	4440lm	4000K
<b>/WW</b>	LED 24V 37,5W	4050lm	3000K
<b>/XW</b>	LED 24V 37,5W	3600lm	2700K



# Matita

Design Mati



Without canopy/driver  
Sin roseta/conductor

CEILING ROSES FOR SUSPENSION SYSTEMS 24V / ROSETAS PARA SISTEMAS DE SUSPENSIÓN DE 24V

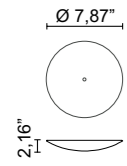

Canopy complete with 60W driver  
Rosetón completa con controlador de 60W

U0990/60 . _ _	Weight
.01 White - Blanco	60 W
.02 Black - Negro	60 W
.85 Painted silver finishing - Plata pintada	60 W
.86 Painted gold finishing - Oro pintado	60 W
.87 Painted copper finishing - Cobre pintado	60 W
.88 Painted bronze finishing - Bronce pintado	60 W

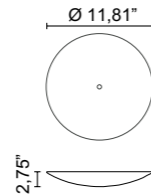

Canopy complete with 99W driver  
Rosetón completa con controlador de 99W

U0990/100 . _ _ / _ _	Weight
.01 White - Blanco	99 W
.02 Black - Negro	99 W
.85 Painted silver finishing - Plata pintada	99 W
.86 Painted gold finishing - Oro pintado	99 W
.87 Painted copper finishing - Cobre pintado	99 W
.88 Painted bronze finishing - Bronce pintado	99 W

/P DIMMER		MAX 75W
/V DIMMER		MAX 75W
/D DIMMER		MAX 75W

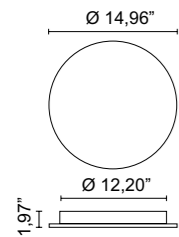

Canopy complete with driver 198W  
Roseta completa con driver de 198W

U0990/200 . _ _ / _ _	Weight
.01 White - Blanco	198 W
.02 Black - Negro	198 W
.85 Painted silver finishing - Plata pintada	198 W
.86 Painted gold finishing - Oro pintado	198 W
.87 Painted copper finishing - Cobre pintado	198 W
.88 Painted bronze finishing - Bronce pintado	198 W

/P DIMMER		MAX 2x75W
/V DIMMER		MAX 2x75W
/D DIMMER		MAX 2x75W

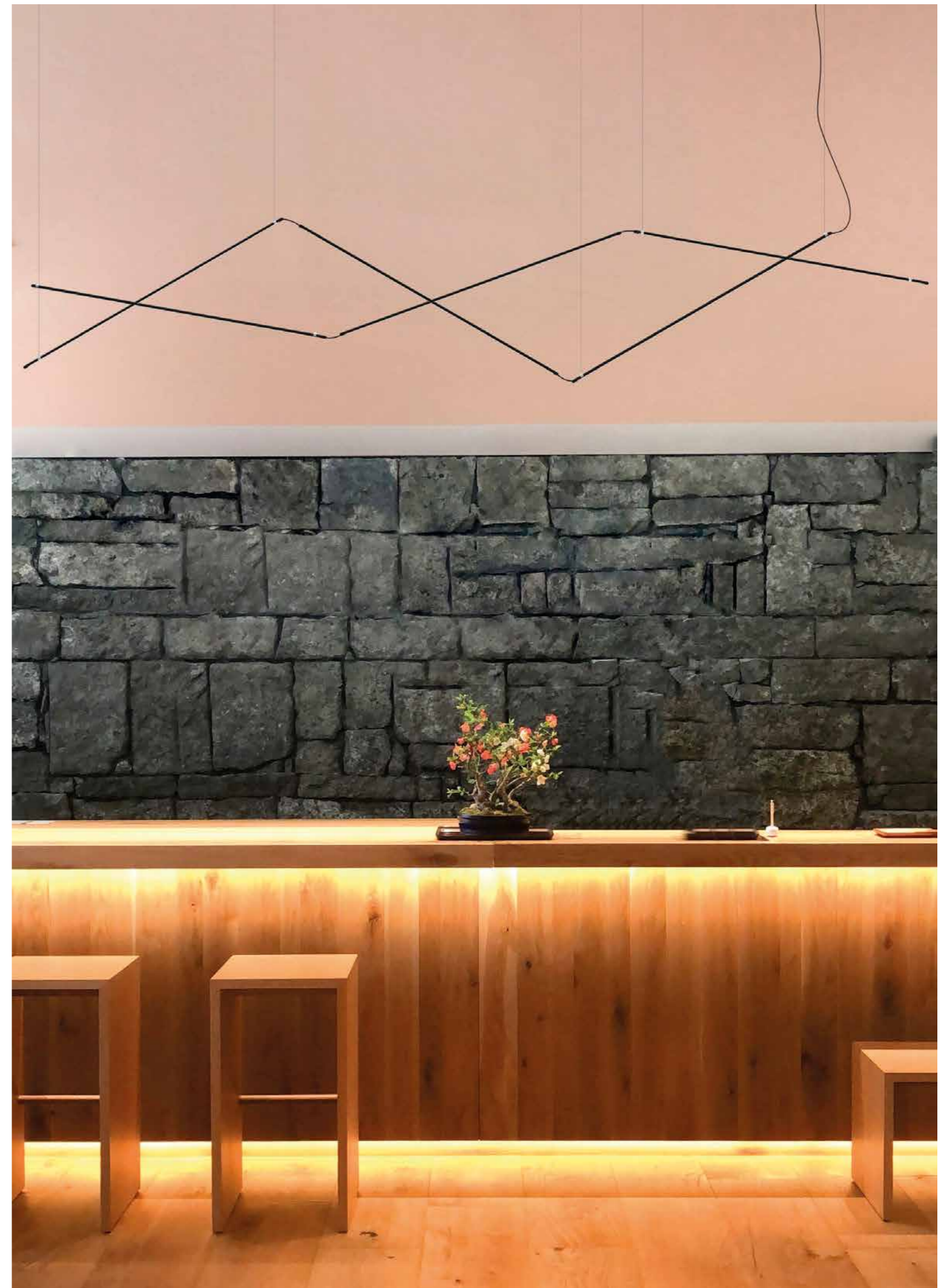

INDOOR

# Radars

Design ABS Studio



Ceiling and suspension lamps with circular lampshade in fabric and self-extinguishing PVC. Aluminum frame and internal diffuser in opal polycarbonate available in 3 diameters: 21,25", 28,34" and 40,15".

*Lámparas de techo y colgantes con pantalla circular de tela y PVC autoextinguible. Marco de aluminio y difusor interior de policarbonato opal disponible en 3 diámetros: 21,25", 28,34" Y 40,15".*

# Radars

Design ABS Studio



# Radar

Design ABS Studio



Dimmable on request  
Regulable bajo pedido

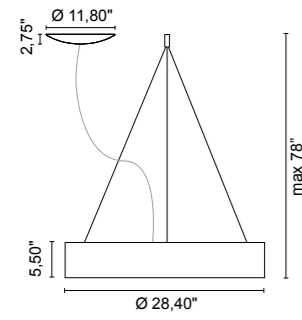

**U1570** / / 5.51 lb

- .01** White - Blanco
- .02.01** Out black / in white - exterior negro interior blanco
- .02.21** Out black / in shiny gold - Negro / interior dorado brillante

/W	4000K	LED 37,8W CRI>90	4746lm
/WW	3000K	LED 37,8W CRI>90	4242lm
/XW	2700K	LED 37,8W CRI>90	3969lm

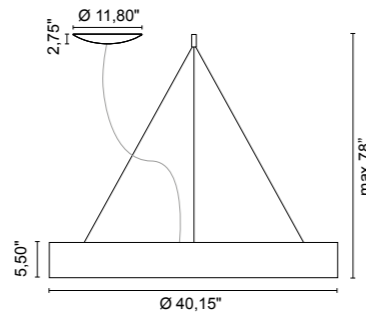

**U1571** / / 6.61 lb

- .01** White - Blanco
- .02.01** Out black / in white - exterior negro interior blanco
- .02.21** Out black / in shiny gold - Negro / interior dorado brillante

/W	4000K	LED 54W CRI>90	6780lm
/WW	3000K	LED 54W CRI>90	6060lm
/XW	2700K	LED 54W CRI>90	5670lm

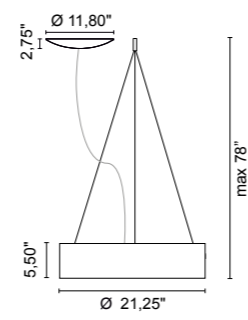

**U1572** / / 3.97 lb

- .01** White - Blanco
- .02.01** Out black / in white - exterior negro interior blanco
- .02.21** Out black / in shiny gold - Negro / interior dorado brillante

/W	4000K	LED 27W CRI>90	3390lm
/WW	3000K	LED 27W CRI>90	3030lm
/XW	2700K	LED 27W CRI>90	2835lm



## FINISHES CODES - CÓDIGOS DE ACABADOS



- .02.21** Out black / in shiny gold  
Negro / interior dorado brillante
- .01** Out white / in white  
Blanco / interior blanco
- .02.01** Out black / in white  
exterior negro interior blanco



INDOOR

# Moonlight

Design ABS Studio

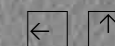

Wall or ceiling lamp with radial emission with MDF front, aluminum structure, internal opal polycarbonate diffuser, integrated driver. Available in 3 dimensions. The original white version can be decorated with different finishes and wallpaper, mirrors and gold and silver leaf solution are available. The unique finish grants the use of water-based paint, making Moonlight a novelty lamp for each space.

*Lámparas de techo o de pared con luz radial caracterizadas por un disco frontal de MDF que puede pintarse con pintura al agua u otro material de su elección. Disponible en tres tamaños. Sólo la versión pequeña está disponible también en acabado espejo. Partiendo de un único punto de suministro, es posible crear composiciones intersectando varios elementos gracias a un Kit especial que debe pedirse por separado (Art.0963). Versión regulable bajo pedido.*



# Moonlight

Design ABS Studio

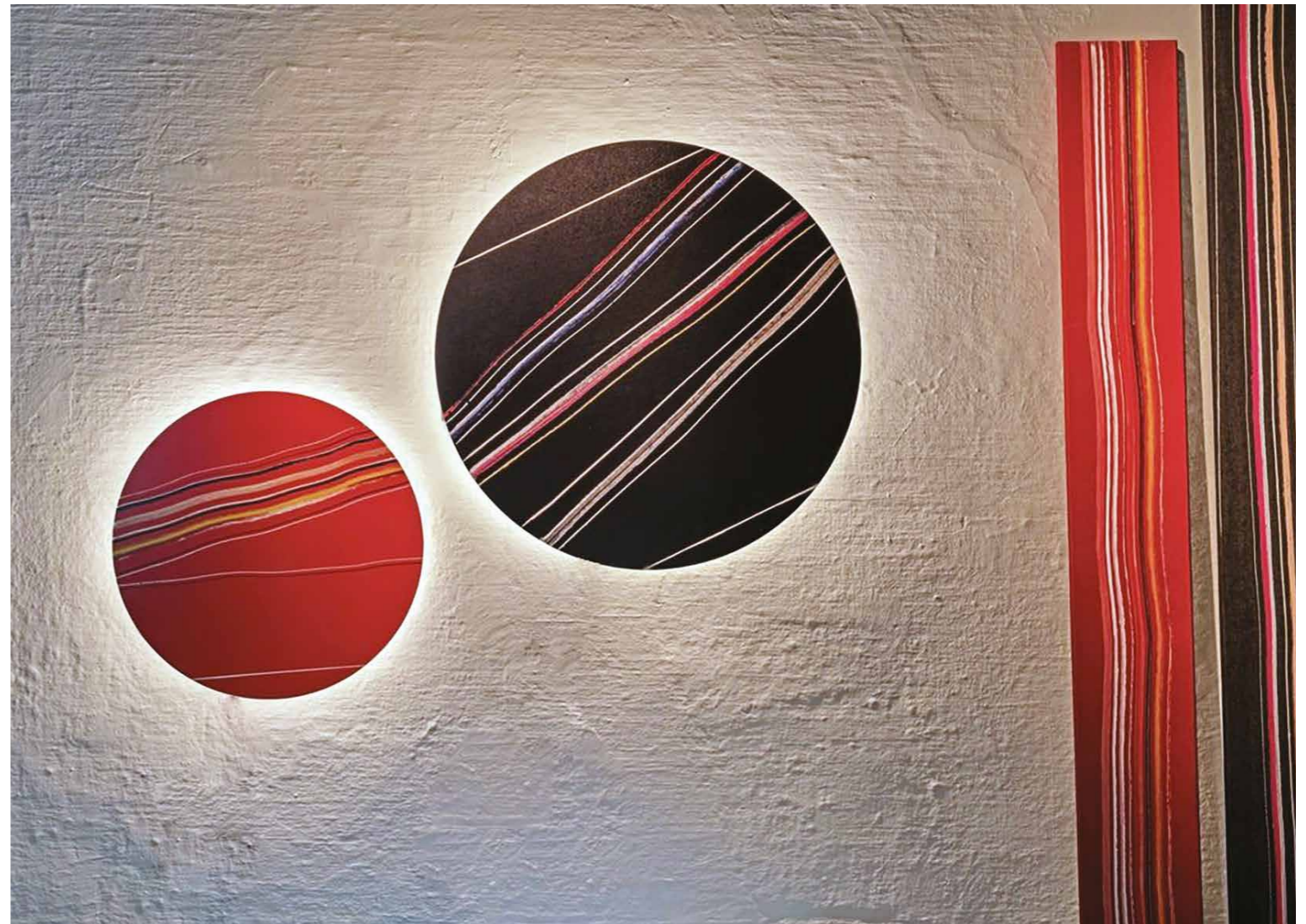



# Moonlight

Design ABS Studio



Dimmable on request  
Regulable bajo pedido

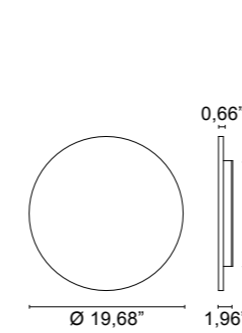

**U4582** / / 3.97 lb

- .01** Raw white - Blanco crudo
- .14** Blackboard - Pizarra
- .29** Gold leaf - Hoja de Oro
- .30** Silver leaf - Hoja de plata
- .56** Mirror - Espejo (No ceiling / Sin techo)

<b>/W</b>	4000K	LED 15W CRI>90	1840lm
<b>/WW</b>	3000K	LED 15W CRI>90	1650lm
<b>/XW</b>	2700K	LED 15W CRI>90	1560lm

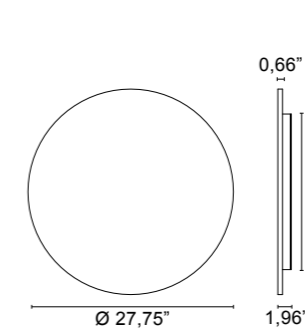

**U4583** / / 6.61 lb

- .01** Raw white - Blanco crudo
- .14** Blackboard - Pizarra
- .29** Gold leaf - Hoja de Oro
- .30** Silver leaf - Hoja de plata
- .56** Mirror - Espejo (No ceiling / Sin techo)

<b>/W</b>	4000K	LED 24W CRI>90	2944lm
<b>/WW</b>	3000K	LED 24W CRI>90	2640lm
<b>/XW</b>	2700K	LED 24W CRI>90	2496lm

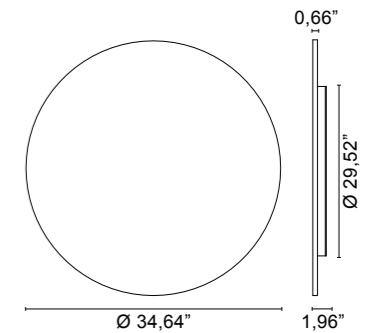

**U4620** / / 8.82 lb

- .01** Raw white - Blanco crudo
- .14** Blackboard - Pizarra
- .29** Gold leaf - Hoja de Oro
- .30** Silver leaf - Hoja de plata
- .56** Mirror - Espejo (No ceiling / Sin techo)

<b>/W</b>	4000K	LED 33W CRI>90	4150lm
<b>/WW</b>	3000K	LED 33W CRI>90	3700lm
<b>/XW</b>	2700K	LED 33W CRI>90	3460lm



## OPTIONAL



Kit for overlapping only for art. U4582-U4583  
Distanciador para instalaciones múltiples sólo para Art. U4582-U4583

## 0963

- .01** White - Blanco

## FINISHES CODES - CÓDIGOS DE ACABADOS



- .01** Raw white to be painted  
Blanco crudo para terminar
- .14** Blackboard  
Pizarra
- .29** Gold leaf  
Hoja de Oro
- .30** Silver leaf  
Hoja de plata
- .56** Mirror  
no ceiling mounting  
Espejo no para techo



# Moonlight

Design ABS Studio

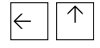

Ph. Flavio Ricci

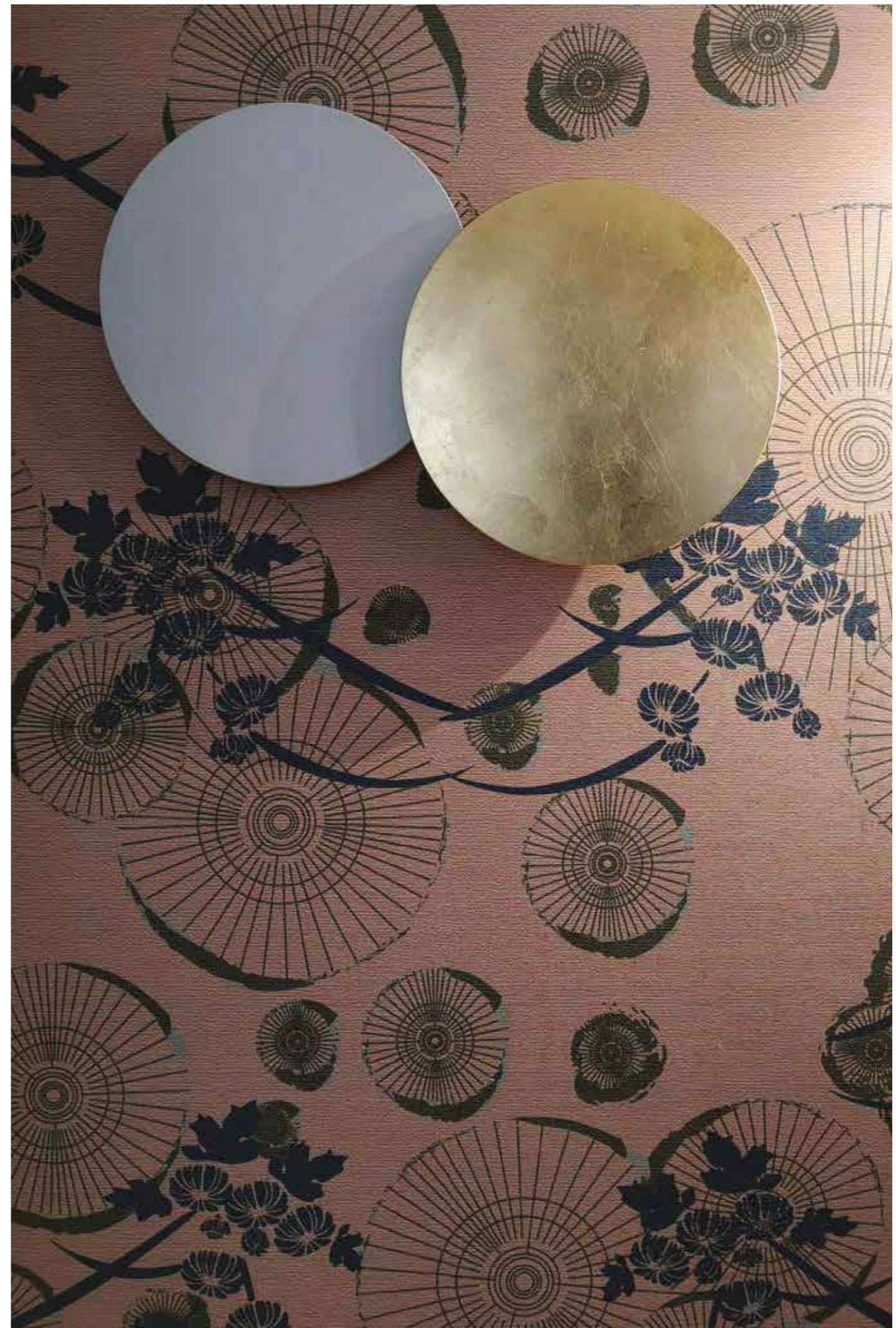
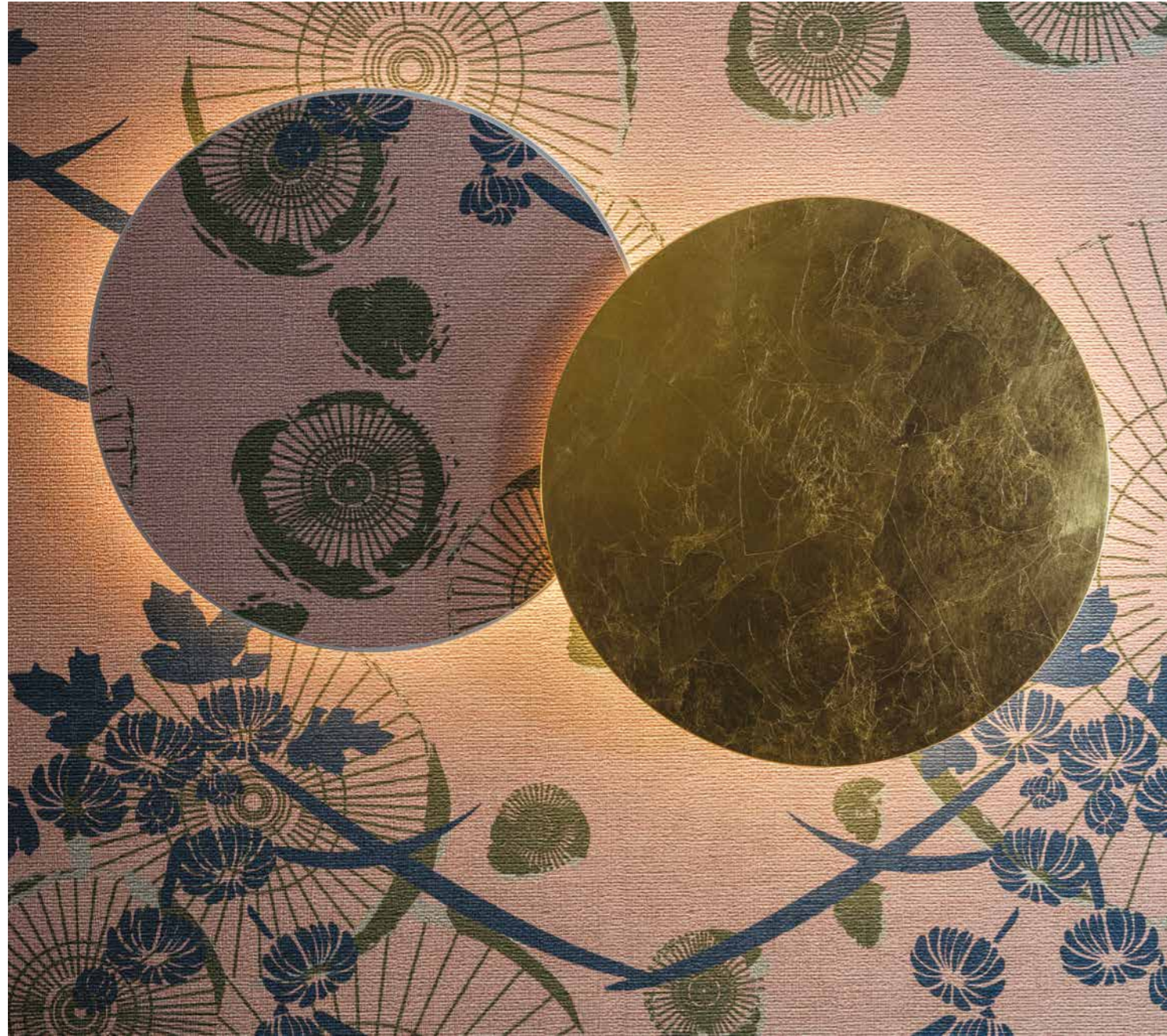

**Moonlight**  
Design ABS Studio





# Moonlight

Design ABS Studio

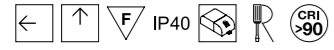

Dimmable on request  
Regulable bajo pedido

## INSTALLATION - INSTALACIÓN

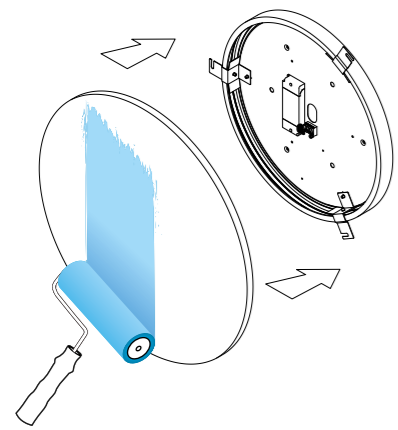
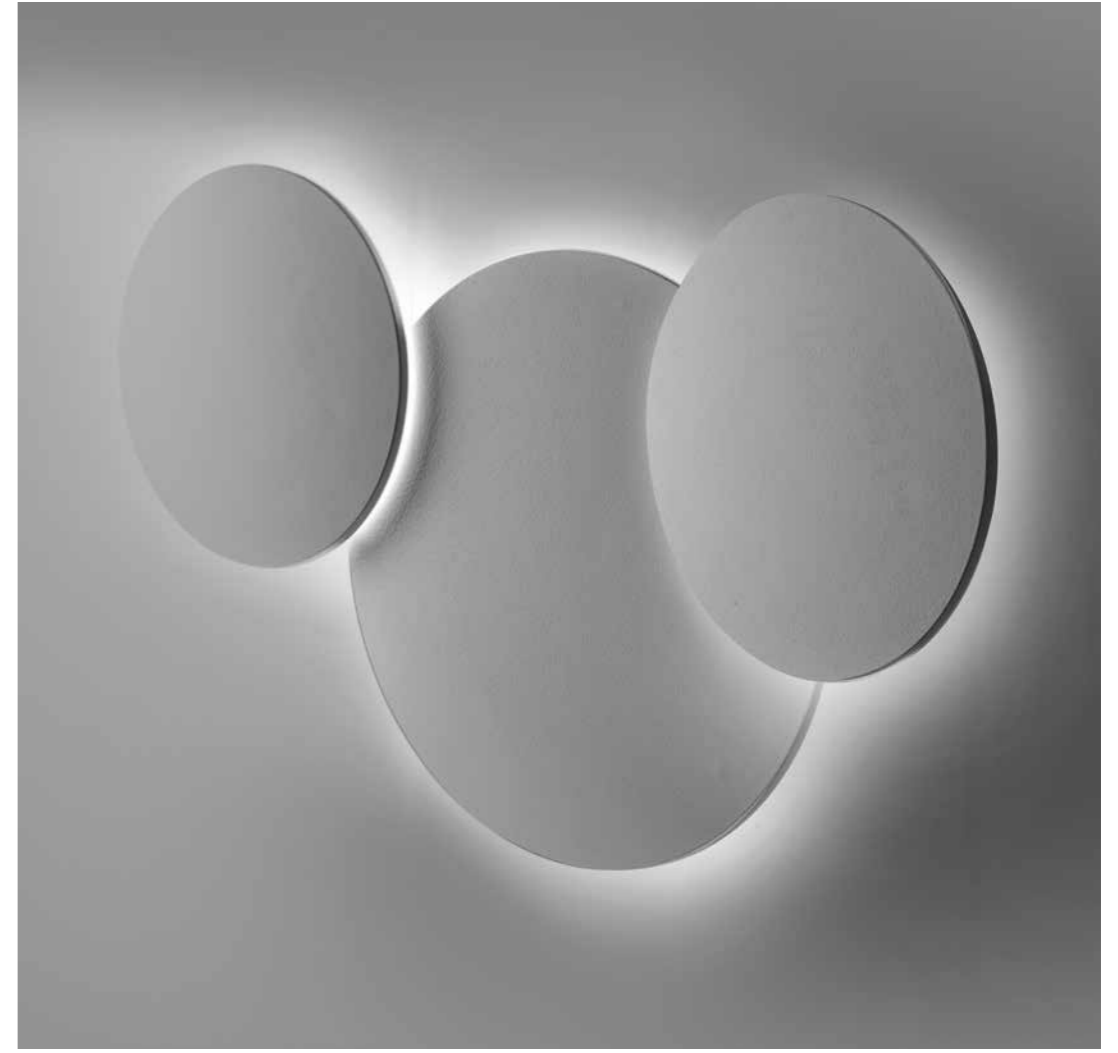
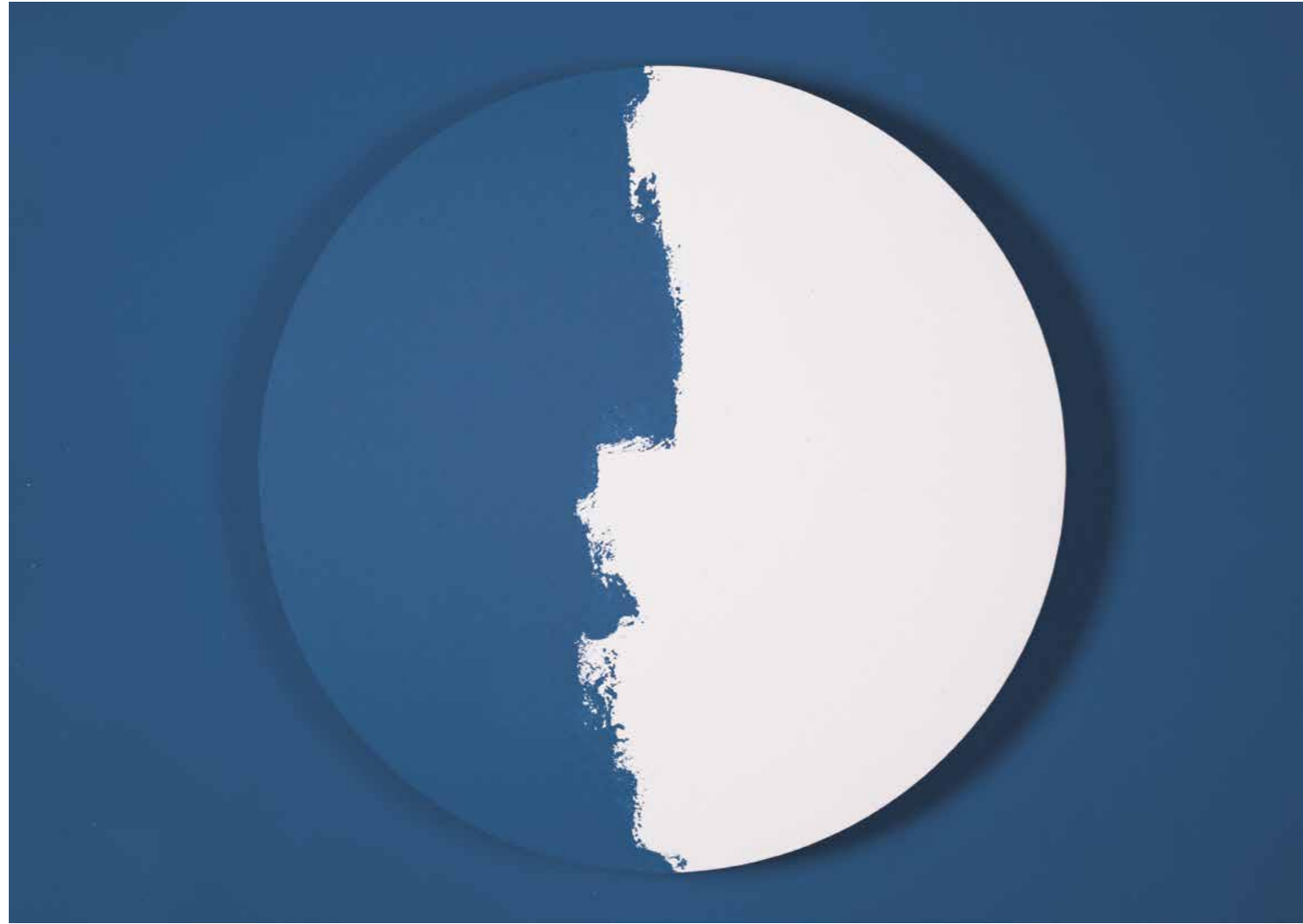

Example of single installation  
Ejemplo de instalación individual

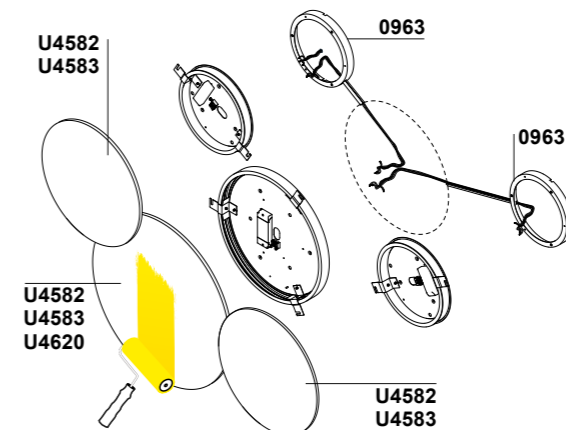

Example of multiple installation with spacers  
Art.0963 can be used in multiple installations as long as it is positioned as a lamp on the wall.

Ejemplo de instalación múltiple con espaciadores el Art.0963 se puede utilizar en múltiples instalaciones siempre que se coloque como lámpara en la pared.

# Moonlight

Design ABS Studio



Project Studio Keyart Milano

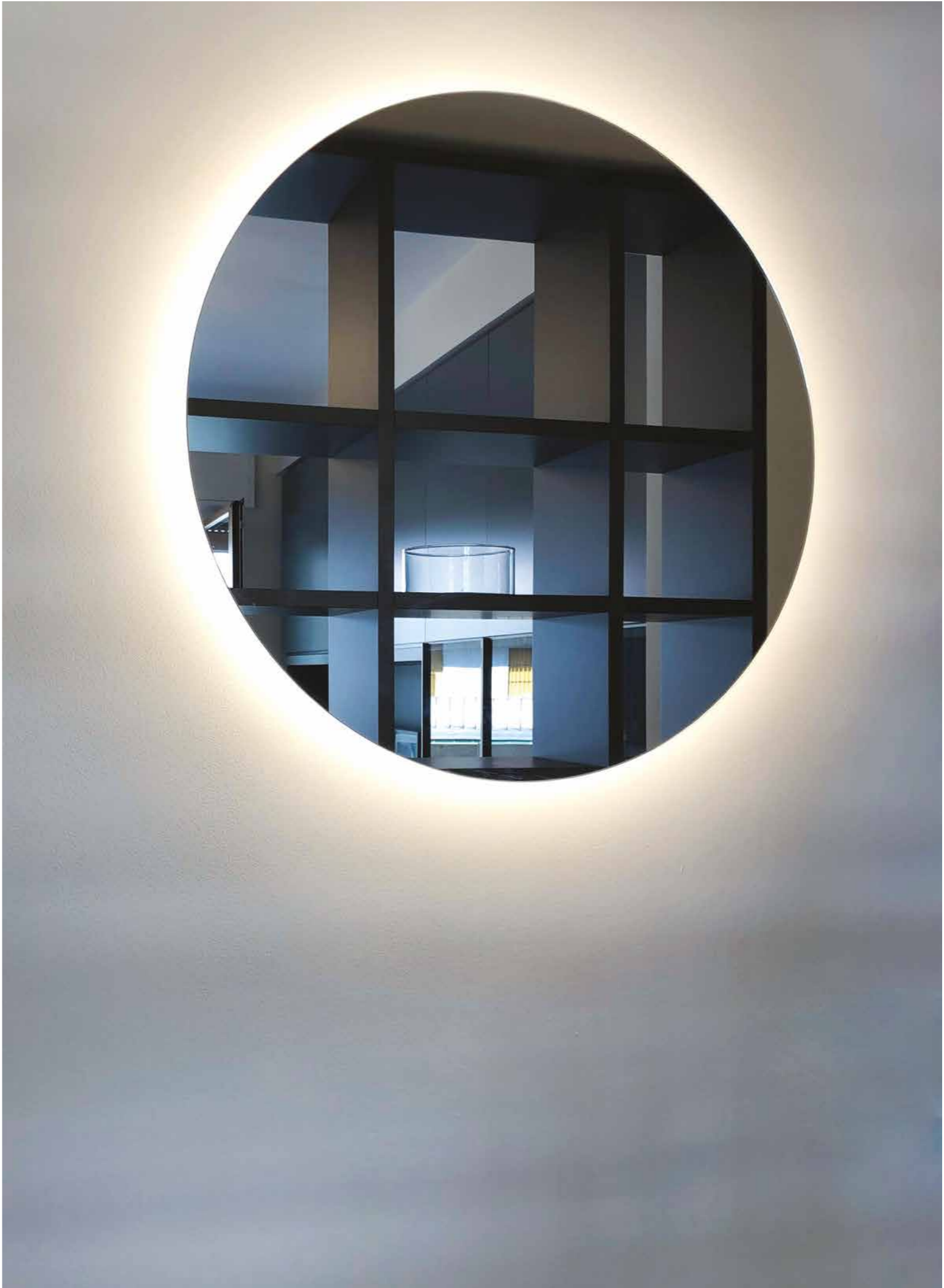

INDOOR

# Tiny

Design: U.T. EGOLUCE

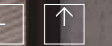

Tiny is a 24V system with a minimalist design that fits in every type of environment and solution. Thanks to the various magnetic components, different customised configurations can be easily and immediately created to meet any requirement. The accessories that can be integrated are: opal or raster inserts that provide diffuse and no glare lighting and spotlights of different sizes. The strength of this product is both the ease with which it can be configured and customised and its low profile that makes it perfect for any type of space.

WARNING!: The track is not sectional

*Tiny es un sistema de 24 V con un diseño minimalista que encaja en cualquier entorno y solución. Gracias a los distintos componentes magnéticos, se pueden crear fácil e inmediatamente diversas configuraciones personalizadas para satisfacer cualquier necesidad. Los accesorios que se pueden integrar son insertos opalescentes o de trama que proporcionan una iluminación difusa y sin deslumbramientos, y focos de diferentes tamaños. El punto fuerte de este producto es tanto su facilidad de configuración y personalización como su perfil bajo, lo que lo hace perfecto para cualquier tipo de espacio.*

*¡ATENCIÓN!: La pista no está seccionada.*

# Tiny - 24V track products

Design U.T. EGOLUCE



# Tiny - 24V track products

Design U.T. EGOLUCE



SYSTEM ELEMENTS *ELEMENTOS LUMINOSOS*

## NEWTON MICRO

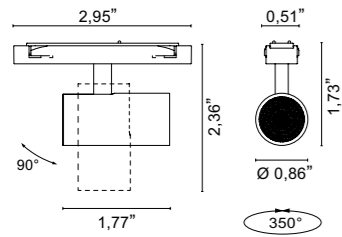

6722.\_ \_ / \_ \_ 0.09 lb

.02 ■ Black - Negro

Optic degree

/WW	/20	3000K	LED 4W	310lm
/XW	/20	2700K upon request	LED 4W	310lm



## NEWTON MINI

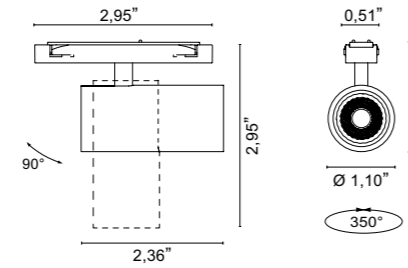

6723.\_ \_ / \_ \_ 0.13 lb

.02 ■ Black - Negro

Optic degree

/WW	/24 /38	3000K	LED 7W	430lm
/XW	/24 /38	2700K upon request	LED 7W	390lm



## SEGMENTO MINI

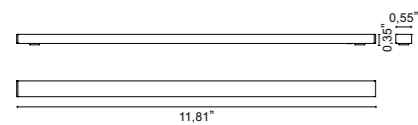

6724.\_ \_ / \_ \_ 0.07 lb

.02 ■ Black - Negro

/WW	3000K	LED 4W	290lm
/XW	2700K upon request	LED 4W	270lm



## SEGMENTO DARK MINI

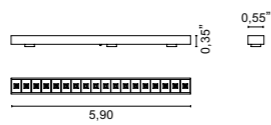

6725.\_ \_ / \_ \_ 0.04 lb

.02 ■ Black - Negro

/WW	3000K	LED 4W	120lm
/XW	2700K upon request	LED 4W	110lm







# Tiny - 24V track products

Design U.T. EGOLUCE

⏪ ⏩ ⚠ WARNING!: THE TRACK IS NOT SECTIONAL / ¡ATENCIÓN!: LA PISTA NO ESTÁ SECCIONADA

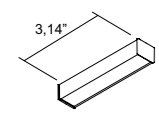
## ACCESSORIES ACCESORIOS

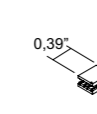
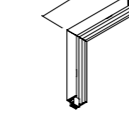
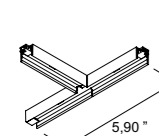
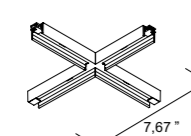
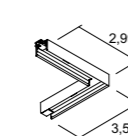
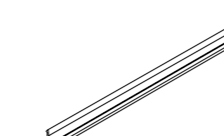
 <p><b>Feed header</b> <i>Cabecera de alimentación</i></p> <p><b>7404._ _</b> <b>.02</b> ■ Black - Negro</p>	 <p><b>End cap</b> <i>Tapa</i></p> <p><b>7405._ _</b> <b>.02</b> ■ Black - Negro</p>	 <p><b>Connection set</b> <i>Conjunto de conexiones</i></p> <p><b>7406._ _</b> <b>.02</b> ■ Black - Negro</p>	 <p><b>90° ceiling/wall junction</b> <i>90° unión techo/pared</i></p> <p><b>7407._ _</b> <b>.02</b> ■ Black - Negro</p>
 <p><b>T-junction</b> <i>Unión en T</i></p> <p><b>7408._ _</b> <b>.02</b> ■ Black - Negro</p>	 <p><b>X-junction</b> <i>Unión en X</i></p> <p><b>7409._ _</b> <b>.02</b> ■ Black - Negro</p>	 <p><b>90° joint</b> <i>Junta de 90°</i></p> <p><b>7410._ _</b> <b>.02</b> ■ Black - Negro</p>	 <p><b>Track coverage 39,37"</b> <i>Cobertura de vía 39,37"</i></p> <p><b>7411._ _</b> <b>.02</b> ■ Black - Negro</p>

## CONFIGURATION EXAMPLE EJEMPLO DE CONFIGURACIÓN

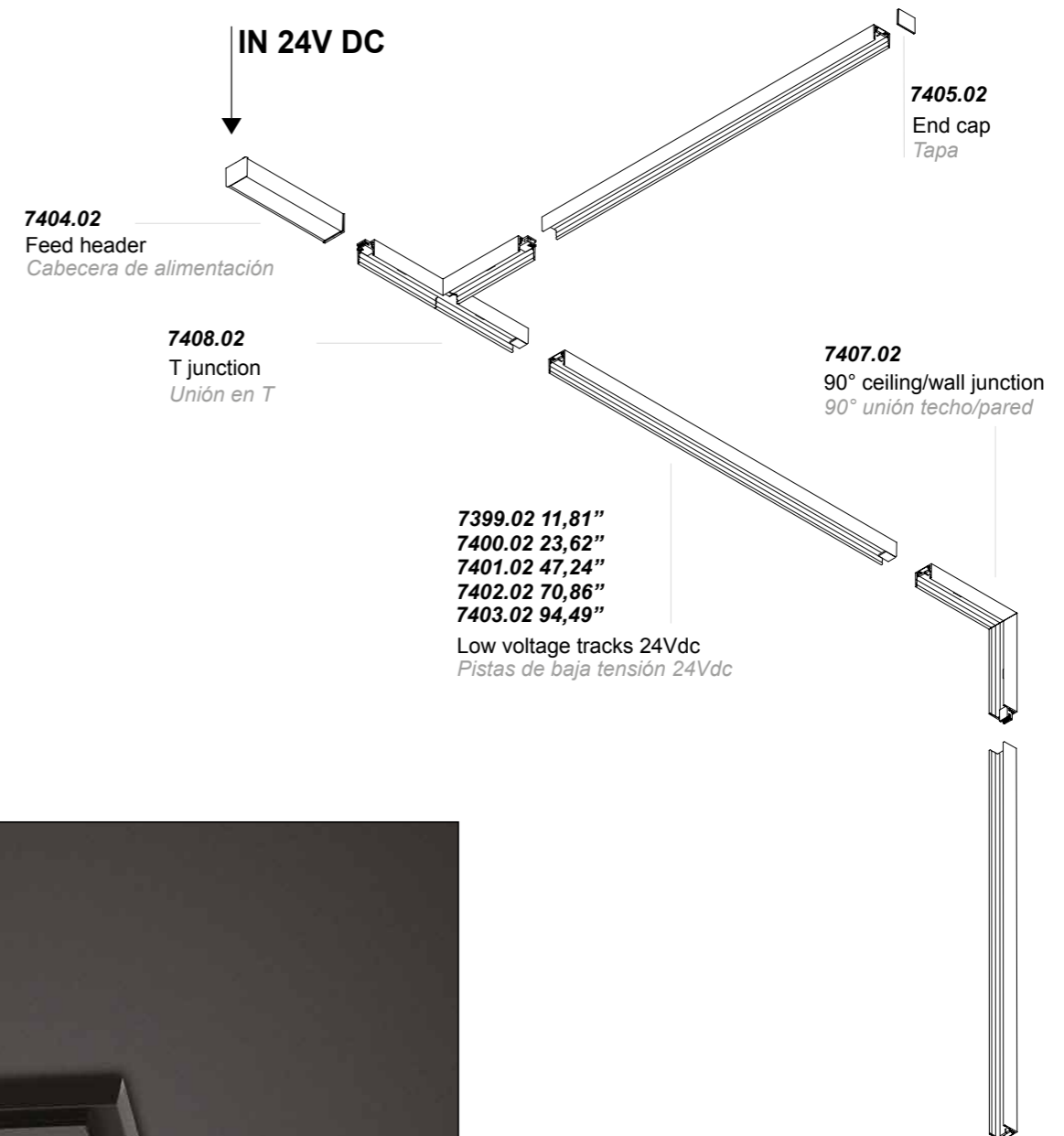

## DRIVERS CONDUCTORES

		<b>6722</b>	<b>6724</b>	<b>6725</b>	<b>6723</b>
<b>U0160/24</b>	IN:120-277V OUT:24V-60W	1-8 spots	1-8 spots	1-8 spots	1-5 spots
<b>U0161/24</b>	IN:120-277V OUT:24V-100W	1-13 spots	1-13 spots	1-13 spots	1-8 spots



### Tiny - 24V track products

Design U.T. EGOLUCE

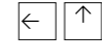

# Tiny - 24V track products

Design U.T. EGOLUCE



## Tiny - 24V track products

Design U.T. EGOLUCE



## Tiny - 24V track products

Design U.T. EGOLUCE

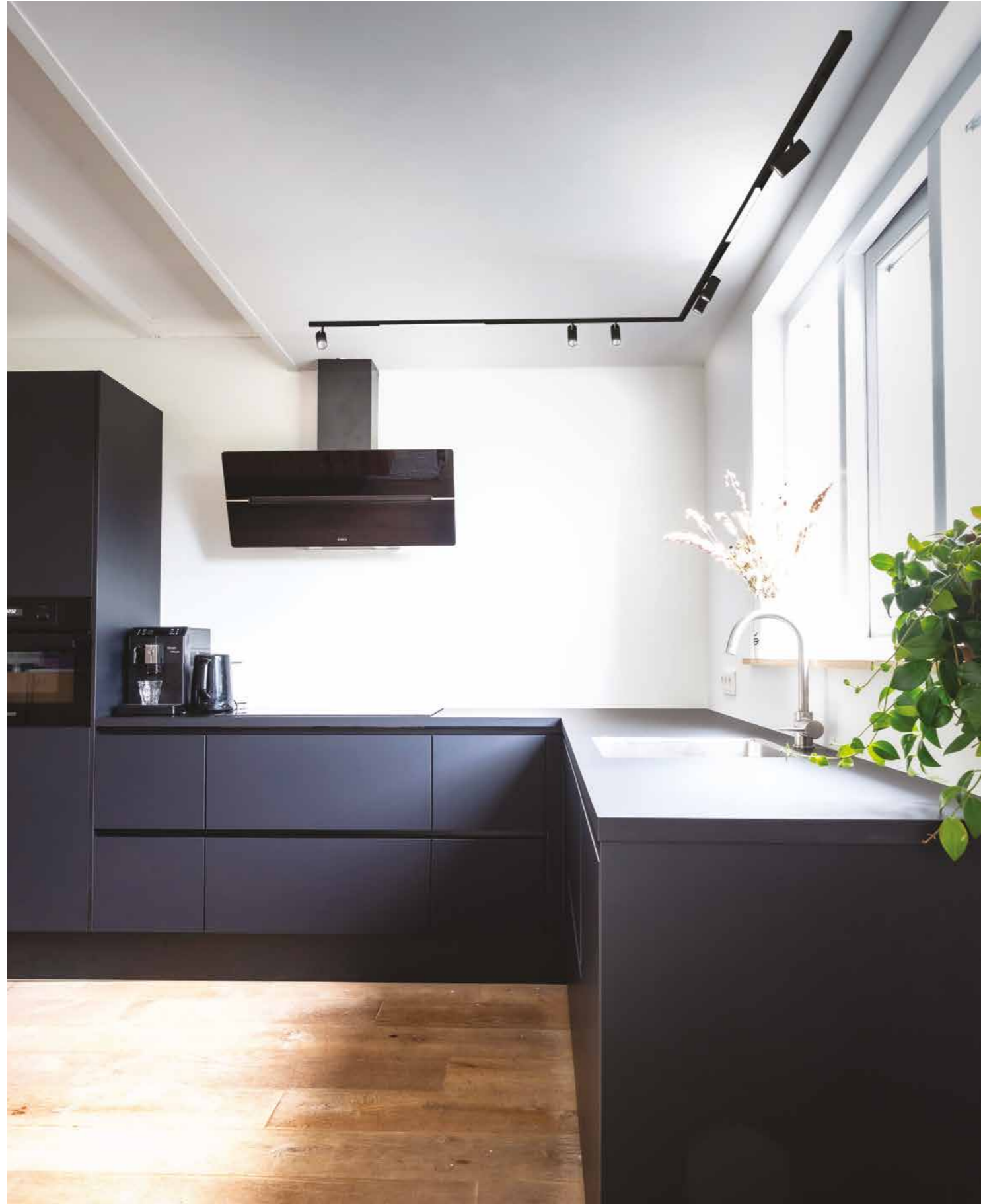



INDOOR

# Newton

Design U.T. EgoLucé



Small projectors with minimal design. The aluminum body is available in three different models with diameters and heights. Finishes: white painted (RAL 9016 opaque), black (matt RAL 9005). Newton permits flexibility where it is possible to horizontally rotate up to 90° and 350° rotation on a vertical axis. Newton is available as a suspension lamp system with an aluminum body COB LED with direct and punctual light and a 3 meters coaxial cable. The source set back and possibly shielded by an opal glass (/ST) guarantees a pleasant non-dazzling effect.

*Proyectores pequeños con un diseño minimalista. El cuerpo de aluminio está disponible en tres modelos distintos con diferentes diámetros y alturas. Acabados: pintado en blanco (RAL 9016 mate), negro (RAL 9005 mate). Newton permite flexibilidad, con la posibilidad de girar horizontalmente hasta 90° y rotar 350° en el eje vertical. Newton está disponible como sistema de luminaria colgante con un cuerpo de LED COB de aluminio para una luz directa y puntual y un cable coaxial de 3 metros. La fuente empotrada, protegida por un cristal opalino (/ST), garantiza un efecto agradable y sin deslumbramientos.*

# Newton Spots

Design U.T. EGOLUCE





## Newton Spots

Design U.T. EGOLUCE





# Newton Spots

Design U.T. EGOLUCE

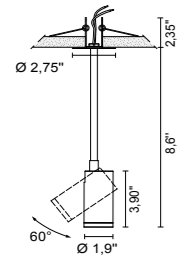

**U6342** \_ \_ / \_ \_ / \_ \_ 1.21 lb

- .01  White - Blanco
- .02  Black - Negro



	Optic degree					
<b>/W</b>	<b>/24 /38 /58</b>	LED 8,9W 500mA	17,8V	1353lm	4000K	
<b>/WW</b>	<b>/24 /38 /58</b>	LED 8,9W 500mA	17,8V	1303lm	3000K	
<b>/XW</b>	<b>/24 /38 /58</b>	LED 8,9W 500mA	17,8V	1244lm	2700K	

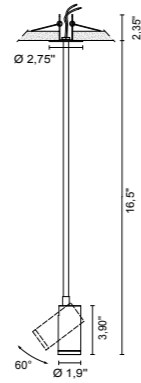

**U6344** \_ \_ / \_ \_ / \_ \_ 7.94 lb

- .01  White - Blanco
- .02  Black - Negro



	Optic degree					
<b>/W</b>	<b>/24 /38 /58</b>	LED 8,9W 500mA	17,8V	1353lm	4000K	
<b>/WW</b>	<b>/24 /38 /58</b>	LED 8,9W 500mA	17,8V	1303lm	3000K	
<b>/XW</b>	<b>/24 /38 /58</b>	LED 8,9W 500mA	17,8V	1244lm	2700K	

## ACCESSORIES ACCESORIOS



Louvres  
Lightbreak

**0267**

- .01  White - Blanco
- .02  Black - Negro

Anti-glare screen  
Pantalla antirreflejos

**0274**

- .01  White - Blanco
- .02  Black - Negro

## AVAILABLE OPTICS / ÓPTICA DISPONIBLE



- /24**  
Narrow beam optic for accent lighting  
*Óptica de haz estrecho para iluminación de acento*
- /38**  
Medium-beam optics  
*Óptica de haz medio*
- /58**  
Wide-beam optics  
*Óptica de haz ancho*
- /ST**  
Diffuse beam optics for general lighting  
*Óptica de haz difuso para iluminación general*

## DRIVERS CONDUCTORES

- 0141/DIM** Multi-power dimmable driver PUSH - 1...10V - 1-2 Newton
- 0141/DALI** Multi-power DALI dimmable driver - 1-2 Newton
- 0145** Multi-power dimmable driver PUSH - 1...10V - 1-3 Newton
- 0145/DALI** Multi-power DALI dimmable driver - 1-3 Newton
- 0127** Drivers 500 mA - 1-6 Newton
- 0128** Drivers 350 mA - 1 Newton



# Newton Spots

Design U.T. EGOLUCE

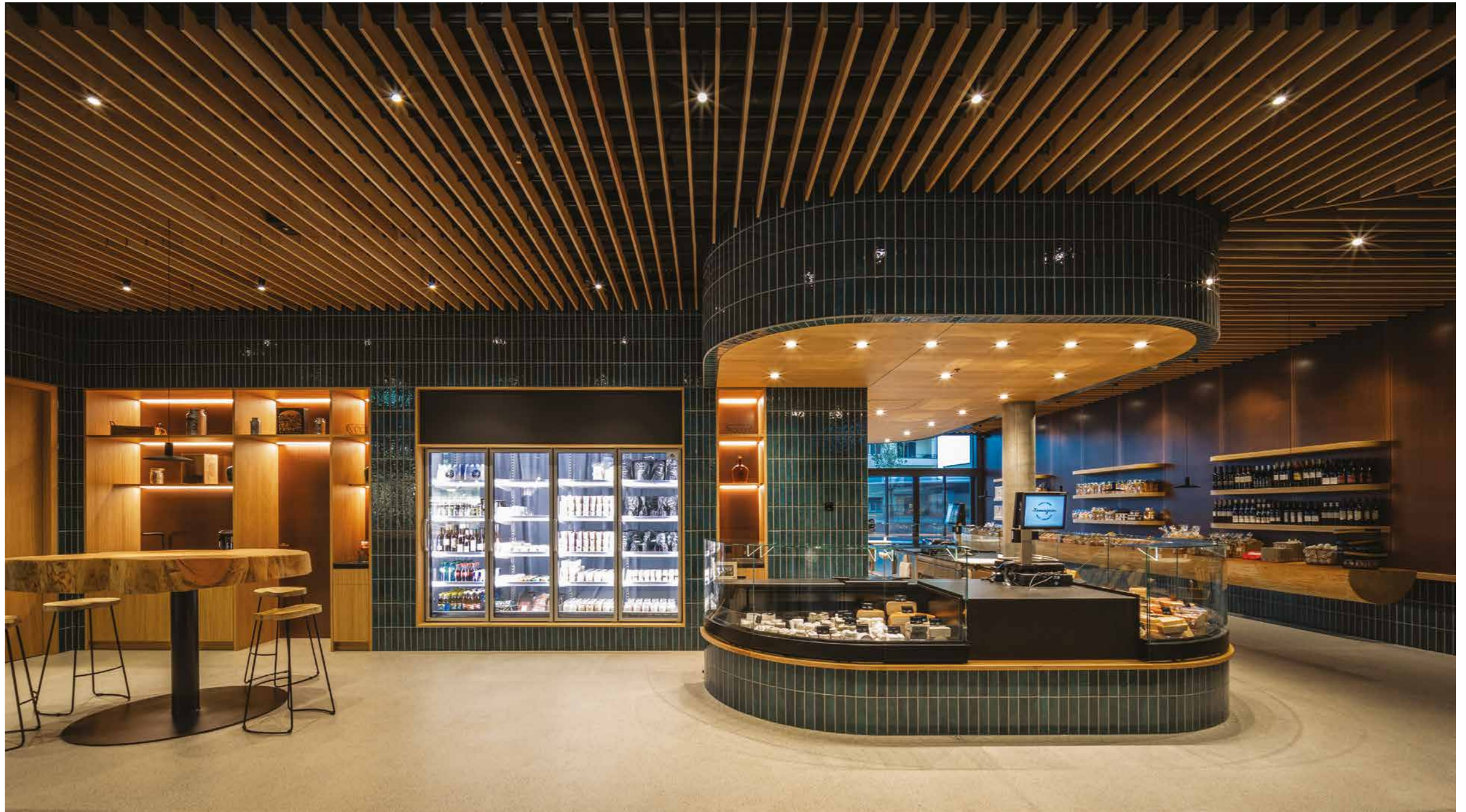

Repond & Nyckees Architectes Sàrl  
Ph. David Boraley

Repond & Nyckees Architectes Sàrl  
Ph. David Boraley

# Newton Spots

Design U.T. EGOLUCE



# Newton Spots Slim

Design U.T. EGOLUCE

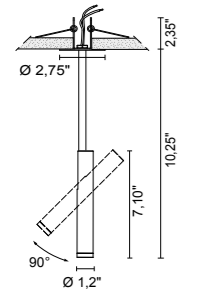

**U6470** \_ \_ / \_ \_ / \_ \_ 0.88 lb

- .01**  White - Blanco
- .02**  Black - Negro



	Optic degree						
<b>/W</b>	<b>/35</b>	<b>/48</b>	<b>/63</b>	LED 8,9W 500mA	17,8V	1353lm	4000K
<b>/WW</b>	<b>/35</b>	<b>/48</b>	<b>/63</b>	LED 8,9W 500mA	17,8V	1303lm	3000K
<b>/XW</b>	<b>/35</b>	<b>/48</b>	<b>/63</b>	LED 8,9W 500mA	17,8V	1244lm	2700K

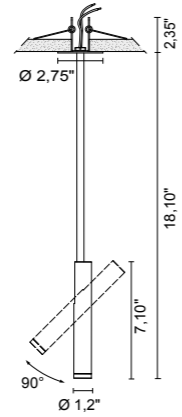

**U6471** \_ \_ / \_ \_ / \_ \_ 1.54 lb

- .01**  White - Blanco
- .02**  Black - Negro



	Optic degree						
<b>/W</b>	<b>/35</b>	<b>/48</b>	<b>/63</b>	LED 8,9W 500mA	17,8V	1353lm	4000K
<b>/WW</b>	<b>/35</b>	<b>/48</b>	<b>/63</b>	LED 8,9W 500mA	17,8V	1303lm	3000K
<b>/XW</b>	<b>/35</b>	<b>/48</b>	<b>/63</b>	LED 8,9W 500mA	17,8V	1244lm	2700K

## ACCESSORIES ACCESORIOS



Sand-blasted Pyrex glass diffuser  
Difusor de vidrio Pyrex arenado

### 0265

- .01**  White - Blanco
- .02**  Black - Negro

## AVAILABLE OPTICS / ÓPTICA DISPONIBLE



**/35**  
Narrow beam optic for accent lighting  
Óptica de haz estrecho para iluminación de acento

**/48**  
Medium-beam optics  
Óptica de haz medio

**/63**  
Wide-beam optics  
Óptica de haz ancho

**/ST**  
Diffuse beam optics for general lighting  
Óptica de haz difuso para iluminación general

## DRIVERS CONDUCTORES

- 0141/DIM** Multi-power dimmable driver PUSH - 1...10V - 1-2 Newton
- 0141/DALI** Multi-power DALI dimmable driver - 1-2 Newton
- 0145** Multi-power dimmable driver PUSH - 1...10V - 1-3 Newton

- 0145/DALI** Multi-power DALI dimmable driver - 1-3 Newton
- 0127** Drivers 500 mA - 1-6 Newton
- 0128** Drivers 350 mA - 1 Newton



# Newton Spots Flat

Design U.T. EGOLUCE





## Newton Spots Flat

Design U.T. EGOLUCE

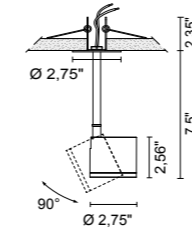

**U6468** \_ \_ / \_ \_ / \_ \_ 1.32 lb

- .01**  White - Blanco
- .02**  Black - Negro



	Optic degree					
<b>/W</b>	<b>/13 /40 /ST</b>	LED 8,9W 500mA	17,8V	1353lm	4000K	
<b>/WW</b>	<b>/13 /40 /ST</b>	LED 8,9W 500mA	17,8V	1303lm	3000K	
<b>/XW</b>	<b>/13 /40 /ST</b>	LED 8,9W 500mA	17,8V	1244lm	2700K	

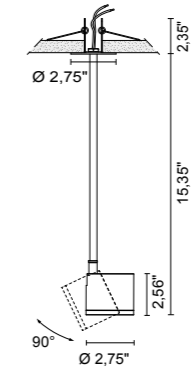

**U6469** \_ \_ / \_ \_ / \_ \_ 1.54 lb

- .01**  White - Blanco
- .02**  Black - Negro



	Optic degree					
<b>/W</b>	<b>/13 /40 /ST</b>	LED 8,9W 500mA	17,8V	1353lm	4000K	
<b>/WW</b>	<b>/13 /40 /ST</b>	LED 8,9W 500mA	17,8V	1303lm	3000K	
<b>/XW</b>	<b>/13 /40 /ST</b>	LED 8,9W 500mA	17,8V	1244lm	2700K	

### ACCESSORIES ACCESORIOS



Decorative parabolic reflector  
*Parábola decorativa*

**0264**

- .01**  White - Blanco
- .02**  Black - Negro

### AVAILABLE OPTICS / ÓPTICA DISPONIBLE



**/13**  
Narrow beam optic for accent lighting  
*Óptica de haz estrecho para iluminación de acento*



**/40**  
Wide-beam optics  
*Óptica de haz ancho*



**/ST**  
Diffuse beam optics for general lighting  
*Óptica de haz difuso para iluminación general*

### DRIVERS CONDUCTORES

- 0141/DIM** Multi-power dimmable driver PUSH - 1...10V - 1-2 Newton
- 0141/DALI** Multi-power DALI dimmable driver - 1-2 Newton
- 0145** Multi-power dimmable driver PUSH - 1...10V - 1-3 Newton

- 0145/DALI** Multi-power DALI dimmable driver - 1-3 Newton
- 0127** Drivers 500 mA - 1-6 Newton
- 0128** Drivers 350 mA - 1 Newton

# Newton Track 48V

Design U.T. EGOLUCE

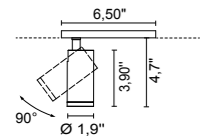
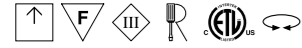

**U6343** \_ \_ / \_ \_ / \_ \_ 0.88 lb

**.01**  White - Blanco

**.02**  Black - Negro



Optic degree

<b>/W</b>	<b>/24 /38 /58</b>	LED 48V DC 8,9W	1353lm	4000K
<b>/WW</b>	<b>/24 /38 /58</b>	LED 48V DC 8,9W	1303lm	3000K
<b>/XW</b>	<b>/24 /38 /58</b>	LED 48V DC 8,9W	1244lm	2700K

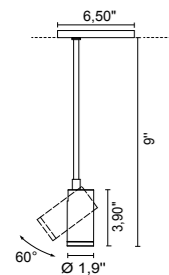

**U6345** \_ \_ / \_ \_ / \_ \_ 1.10 lb

**.01**  White - Blanco

**.02**  Black - Negro



Optic degree

<b>/W</b>	<b>/24 /38 /58</b>	LED 48V DC 8,9W	1353lm	4000K
<b>/WW</b>	<b>/24 /38 /58</b>	LED 48V DC 8,9W	1303lm	3000K
<b>/XW</b>	<b>/24 /38 /58</b>	LED 48V DC 8,9W	1244lm	2700K

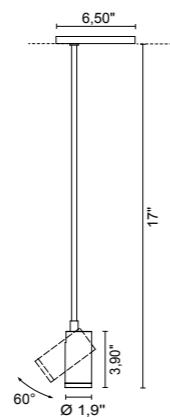

**U6346** \_ \_ / \_ \_ / \_ \_ 1.54 lb

**.01**  White - Blanco

**.02**  Black - Negro



Optic degree

<b>/W</b>	<b>/24 /38 /58</b>	LED 48V DC 8,9W	1353lm	4000K
<b>/WW</b>	<b>/24 /38 /58</b>	LED 48V DC 8,9W	1303lm	3000K
<b>/XW</b>	<b>/24 /38 /58</b>	LED 48V DC 8,9W	1244lm	2700K



## ACCESSORIES ACCESORIOS



Louvres  
Lightbreak

**0267**

**.01**  White - Blanco

**.02**  Black - Negro



Anti-glare screen  
Pantalla antirreflejos

**0274**

**.01**  White - Blanco

**.02**  Black - Negro

## AVAILABLE OPTICS / ÓPTICA DISPONIBLE



**/24**

Narrow beam optic for accent lighting  
Óptica de haz estrecho para iluminación de acento



**/38**

Medium-beam optics  
Óptica de haz medio



**/58**

Wide-beam optics  
Óptica de haz ancho



**/ST**

Diffuse beam optics for general lighting  
Óptica de haz difuso para iluminación general

# Newton Slim Track 48V

Design U.T. EGOLUCE





# Newton Slim Track 48V

Design U.T. EGOLUCE

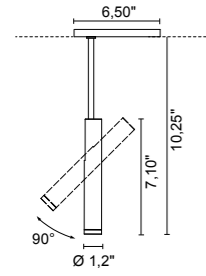

**U6451** \_ \_ / \_ \_ / \_ \_ 1.10 lb

- .01**  White - Blanco
- .02**  Black - Negro



	Optic degree				
<b>/W</b>	<b>/35 /48 /63</b>	LED 48V DC 8,9W	1353lm	4000K	
<b>/WW</b>	<b>/35 /48 /63</b>	LED 48V DC 8,9W	1303lm	3000K	
<b>/XW</b>	<b>/35 /48 /63</b>	LED 48V DC 8,9W	1244lm	2700K	

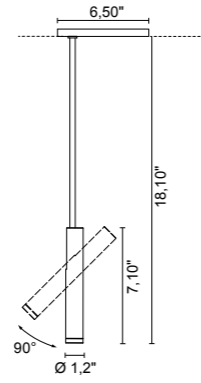

**U6452** \_ \_ / \_ \_ / \_ \_ 1.32 lb

- .01**  White - Blanco
- .02**  Black - Negro



	Optic degree				
<b>/W</b>	<b>/35 /48 /63</b>	LED 48V DC 8,9W	1353lm	4000K	
<b>/WW</b>	<b>/35 /48 /63</b>	LED 48V DC 8,9W	1303lm	3000K	
<b>/XW</b>	<b>/35 /48 /63</b>	LED 48V DC 8,9W	1244lm	2700K	

## ACCESSORIES ACCESORIOS



Sand-blasted Pyrex glass diffuser  
Difusor de vidrio Pyrex arenado

**0265**

- .01**  White - Blanco
- .02**  Black - Negro

## AVAILABLE OPTICS / ÓPTICA DISPONIBLE



**/35**  
Narrow beam optic for accent lighting  
Óptica de haz estrecho para iluminación de acento



**/48**  
Medium-beam optics  
Óptica de haz medio



**/63**  
Wide-beam optics  
Óptica de haz ancho



**/ST**  
Diffuse beam optics for general lighting  
Óptica de haz difuso para iluminación general



# Newton Flat Track 48V

Design U.T. EGOLUCE

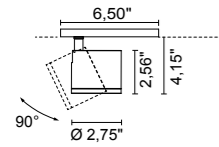

**U6448** \_ / \_ / \_ 1.10 lb

**.01**  White - Blanco



**.02**  Black - Negro

Optic degree

/W	/13	/40	/ST	LED 48V DC 8,9W	1353lm	4000K
/WW	/13	/40	/ST	LED 48V DC 8,9W	1303lm	3000K
/XW	/13	/40	/ST	LED 48V DC 8,9W	1244lm	2700K

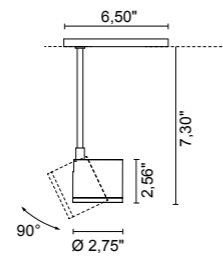

**U6449** \_ / \_ / \_ 1.32 lb

**.01**  White - Blanco



**.02**  Black - Negro

Optic degree

/W	/13	/40	/ST	LED 48V DC 8,9W	1353lm	4000K
/WW	/13	/40	/ST	LED 48V DC 8,9W	1303lm	3000K
/XW	/13	/40	/ST	LED 48V DC 8,9W	1244lm	2700K

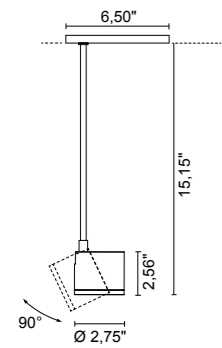

**U6450** \_ / \_ / \_ 1.54 lb

**.01**  White - Blanco



**.02**  Black - Negro

Optic degree

/W	/13	/40	/ST	LED 48V DC 8,9W	1353lm	4000K
/WW	/13	/40	/ST	LED 48V DC 8,9W	1303lm	3000K
/XW	/13	/40	/ST	LED 48V DC 8,9W	1244lm	2700K

## ACCESSORIES ACCESORIOS



Decorative parabolic reflector  
*Parábola decorativa*

**0264**

**.01**  White - Blanco

**.02**  Black - Negro

## AVAILABLE OPTICS / ÓPTICA DISPONIBLE



**/13**  
Narrow beam optic for accent lighting  
*Óptica de haz estrecho para iluminación de acento*

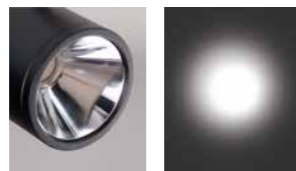

**/40**  
Wide-beam optics  
*Óptica de haz ancho*



**/ST**  
Diffuse beam optics for general lighting  
*Óptica de haz difuso para iluminación general*



# Track 48V

Design U.T. EGOLUCE



48V low voltage electrified tracks for ceiling, wall, suspensions applications. / Carriles electrificados de baja tensión de 48 V para aplicaciones de techo, pared y suspensión.

<b>U7341._ _</b>	39.37"	1.52 lb
.01  White - Blanco		
.02  Black - Negro		
<b>U7342._ _</b>	78.74"	3.04 lb
.01  White - Blanco		
.02  Black - Negro		
<b>U7343._ _</b>	118.11"	4.56 lb
.01  White - Blanco		
.02  Black - Negro		

## CONFIGURATION EXAMPLE EJEMPLO DE CONFIGURACIÓN

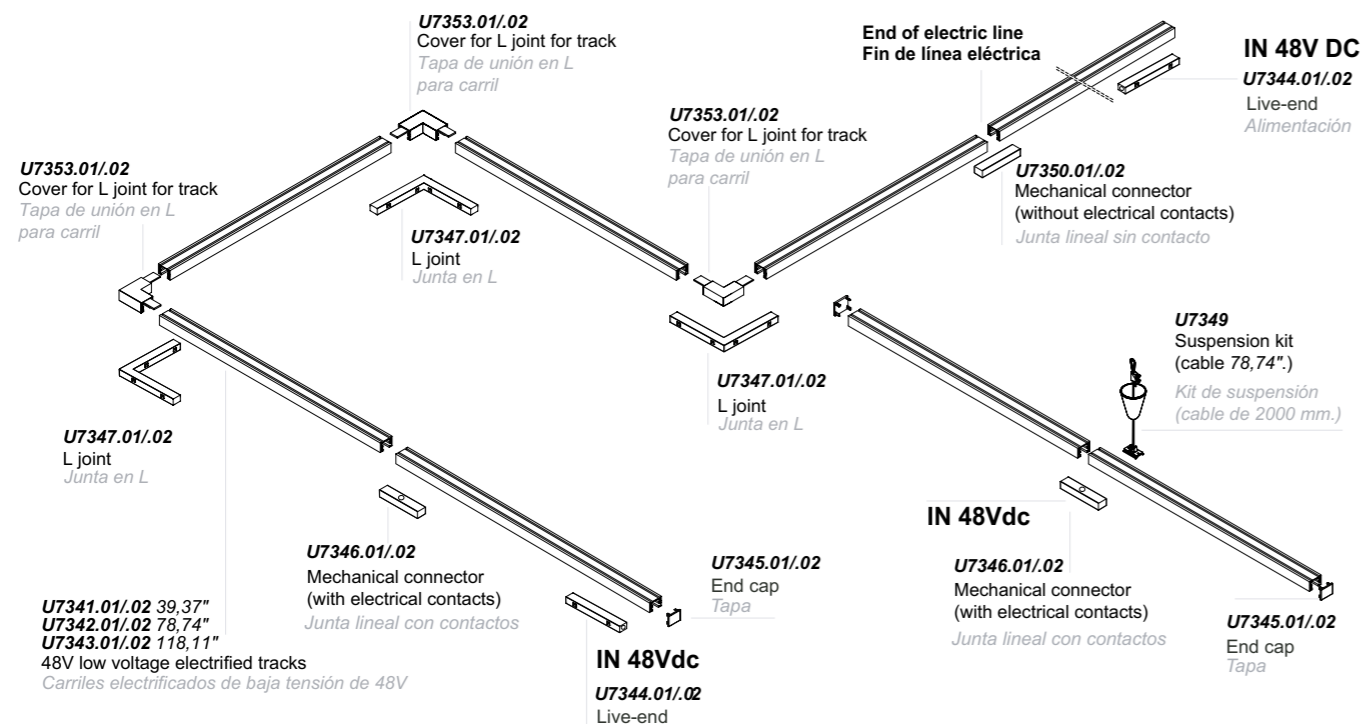

## ACCESSORIES ACCESORIOS

<b>U7344._ _</b> Live-end <i>Alimentación</i>	<b>U7345._ _</b> End cap <i>Tapa</i>	<b>U7346._ _</b> Mechanical connector (with electrical contacts) <i>Junta lineal con contactos</i>	<b>U7347._ _</b> L joint <i>Junta en L</i>
.01  White - Blanco	.01  White - Blanco	.01  White - Blanco	.01  White - Blanco
.02  Black - Negro	.02  Black - Negro	.02  Black - Negro	.02  Black - Negro
<b>U7349._ _</b> Suspension kit (cable 78.74") <i>Kit de suspensión (cable de 78.74")</i>	<b>U7350._ _</b> Mechanical connector (without electrical contacts) <i>Junta lineal sin contacto</i>	<b>U7353._ _</b> Cover for L joint for track <i>Tapa de unión en L para carril</i>	
.01  White - Blanco	.01  White - Blanco	.01  White - Blanco	
.02  Black - Negro	.02  Black - Negro	.02  Black - Negro	

## DRIVERS CONDUCTORES

<b>U0160/48</b>	IN:90-264V OUT:48V-60W 1-4 Newton
<b>U0161/48</b>	IN:90-264V OUT:48V-100W 1-9 Newton
<b>U0162/48</b>	IN:90-305V OUT:48V-120W 1-10 Newton

# Newton System

Design U.T. EGOLUCE



# Newton System

Design U.T. EGOLUCE



2 displacement elements included  
2 elementos de descentralización incluidos

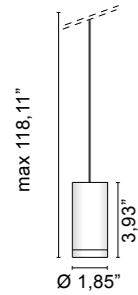

**U1591.** \_ / \_ / \_ 1.10 lb

- .02** ■ Black - Negro
- .25** ■ Golded satin - Oro satinado
- .32** ■ Nickel mat - Níquel satinado



Optic degree							
<b>/W</b>	<b>/ST</b>	LED 6,1W 350mA	17,3V	975lm	4000K		
<b>/WW</b>	<b>/ST</b>	LED 6,1W 350mA	17,3V	939lm	3000K		
<b>/XW</b>	<b>/ST</b>	LED 6,1W 350mA	17,3V	896lm	2700K		

## OPTIONAL



Displacement component  
Elemento de descentralización

**0612** 0.02 lb

- .01** ■ White - Blanco
- .02** ■ Black - Negro

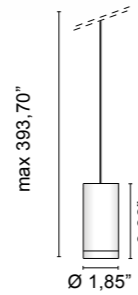

**U1592.** \_ / \_ / \_ 1.54 lb

- .02** ■ Black - Negro
- .25** ■ Golded satin - Oro satinado
- .32** ■ Nickel mat - Níquel satinado



Optic degree							
<b>/W</b>	<b>/ST</b>	LED 6,1W 350mA	17,3V	975lm	4000K		
<b>/WW</b>	<b>/ST</b>	LED 6,1W 350mA	17,3V	939lm	3000K		
<b>/XW</b>	<b>/ST</b>	LED 6,1W 350mA	17,3V	896lm	2700K		

## AVAILABLE OPTICS / ÓPTICA DISPONIBLE



**/ST**  
Diffuse beam optics for general lighting  
Óptica de haz difuso para iluminación general

## DECORATIVE ACCESSORIES / ACCESORIOS DECORATIVOS

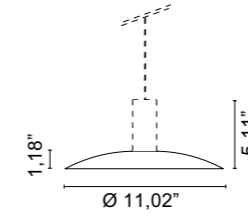

Black painted metal screen  
Pantalla metálica pintada de negro

**0547.** \_ \_  
**.02** ■ Black - Negro

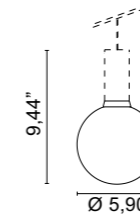

Transparent blown glass diffuser  
Difusor de vidrio soplado transparente

**0549.** \_ \_ **.00**  
**.02** ■ Black - Negro  
**.25** ■ Golded satin - Oro satinado  
**.32** ■ Nickel mat - Níquel satinado

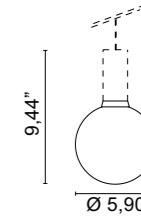

Transparent blown white diffuser  
Difusor de vidrio soplado blanco

**0549.** \_ \_ **.57**  
**.02** ■ Black - Negro  
**.25** ■ Golded satin - Oro satinado  
**.32** ■ Nickel mat - Níquel satinado

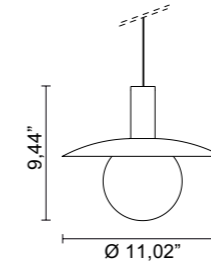

Black painted metal screen + Transparent blown glass diffuser  
Pantalla metálica pintada de negro + Difusor de cristal soplado transparente

**0547.02 + 0549.** \_ \_ **.00**  
**.02** ■ Black - Negro  
**.25** ■ Golded satin - Oro satinado  
**.32** ■ Nickel mat - Níquel satinado

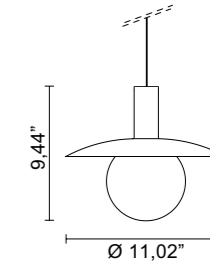

Black painted metal screen + Transparent blown white diffuser  
Pantalla metálica pintada de negro + Difusor de cristal soplado blanco

**0547.02 + 0549.** \_ \_ **.57**  
**.02** ■ Black - Negro  
**.25** ■ Golded satin - Oro satinado  
**.32** ■ Nickel mat - Níquel satinado

## FINISHES CODES - CÓDIGOS DE ACABADOS



**.02** Black Negro  
**.25** Golded satin Oro satinado  
**.32** Nickel mat Níquel satinado

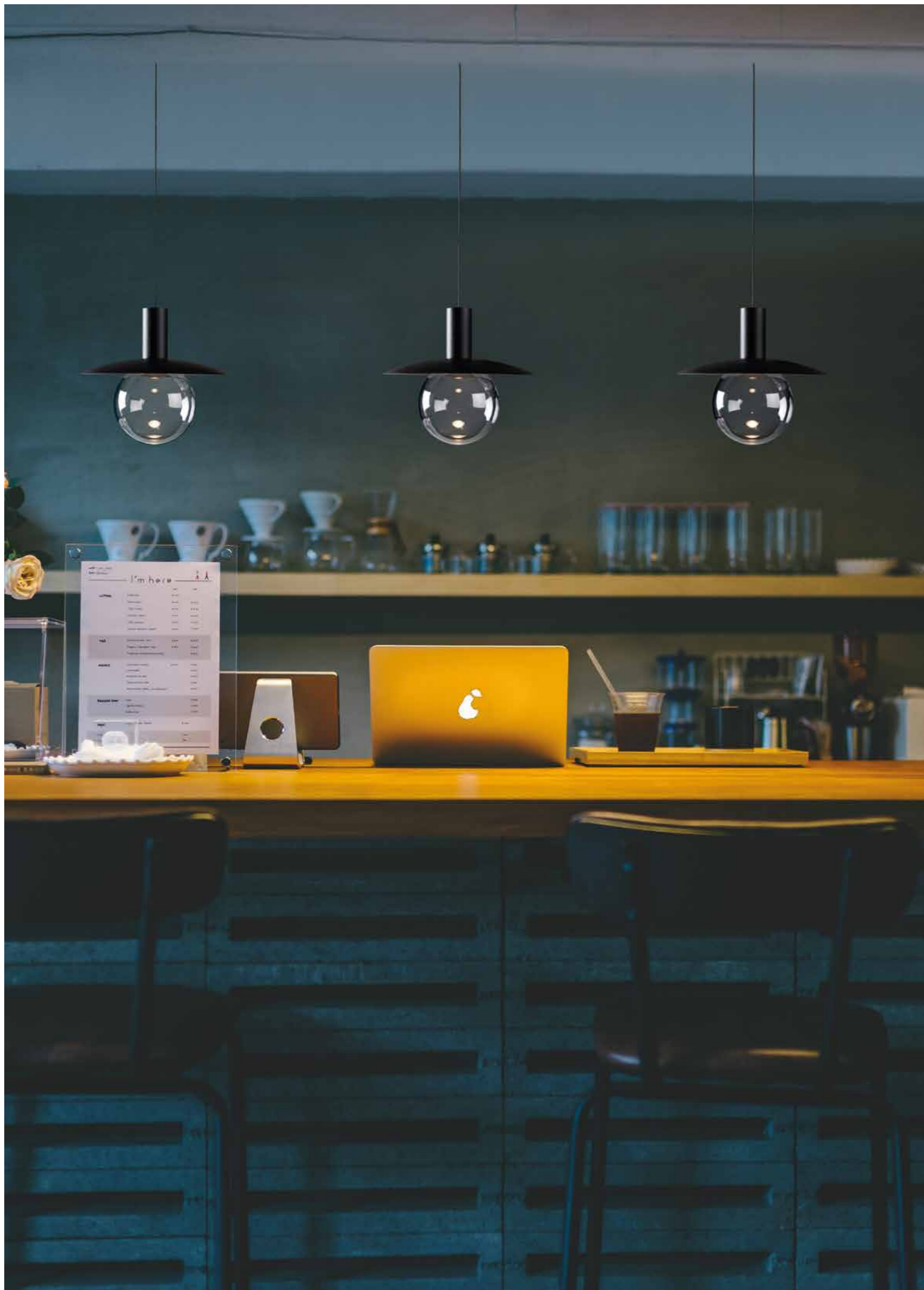

## Newton System

Design U.T. EGOLUCE



# Newton System

Design U.T. EGOLUCE



# Newton System

Design U.T. EGOLUCE



CEILING CANOPY FOR SUSPENSION SYSTEMS 350mA ACCESORIOS Y ROSETAS CON CONTROLADOR UL PARA SISTEMAS DE SUSPENSIÓN DE 350 MA



**IN:** 50/60Hz 100/127V  
**OUT:** 350mA DC



Ceiling canopy for plasterboard with springs and driver | NB from the 3" recessed hole through driver  
*Muelles para carton yeso incluye | NB el driver pasa por el mismo agujero de 3" a través del conductor*

**U0970.** \_ \_

- .01  White - Blanco
- .02  Black - Negro



**IN:** 50/60Hz 100/127V  
**OUT:** 350mA DC



Round canopy D.7,9" - H.1,2" with central outlet. | on UL-marked driver one per lamp  
*Rosetón redondo D.7,9" - H.1,2" con salida central | en controladores con marca UL uno por lámpara*

**U0557/1.** \_ \_

- .01  White - Blanco
- .02  Black - Negro



**IN:** 50/60Hz 100/127V  
**OUT:** 350mA DC



Round rosette D.13,8"- H.1,81" with three outlets | with three UL-marked drivers one per lamp  
*Rosetón redondo D.13,8"- H.1,81" con tres salidas | con tres controladores con marca UL, uno por lámpara*

**U0980/3.** \_ \_

- .01  White - Blanco
- .02  Black - Negro



**IN:** 50/60Hz 100/127V  
**OUT:** 350mA DC

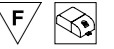

Round canopy 18,9"x9,4" - H.1,2" with two outlets. | with two UL-marked drivers one per lamp  
*Rosetón redondo 18,9"x9,4" - H.1,2" con dos salidas | con dos controladores con marca UL, uno por lámpara*

**U0980/5.** \_ \_

- .01  White - Blanco
- .02  Black - Negro



**IN:** 50/60Hz 100/127V  
**OUT:** 350mA DC



Round canopy D.7,9" - H.1,2" with two radial outlets | with two UL-marked drivers one per lamp  
*Rosetón redondo D.7,9" - H.1,2" con dos salidas radiales | con dos controladores con marca UL, uno por lámpara*

**U0557/2.** \_ \_

- .01  White - Blanco
- .02  Black - Negro



**IN:** 50/60Hz 100/127V  
**OUT:** 350mA DC



Round rosette D.15" - H.1,2" with three radial outlets | with three UL-marked drivers one per lamp  
*Rosetón redondo D.15" - H.1,2" con tres salidas radiales | con tres controladores con marca UL, uno por lámpara*

**U0557/3.** \_ \_

- .01  White - Blanco
- .02  Black - Negro

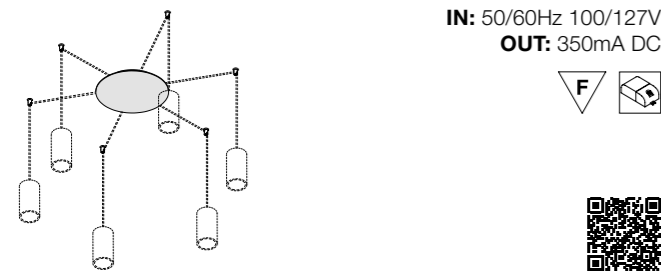

**IN:** 50/60Hz 100/127V  
**OUT:** 350mA DC



Round rosette D.15" - H.1,2" with six radial outlets | with six UL-marked drivers one per lamp  
*Rosetón redondo D.15" - H.1,2" con seis salidas radiales | con seis controladores con marca UL, uno por lámpara*

**U0557/6.** \_ \_

- .01  White - Blanco
- .02  Black - Negro



**IN:** 50/60Hz 100/127V  
**OUT:** 350mA DC



Rectangular canopy 18,89"x9,44" - H.1,18" with two outlets. | with two UL-marked drivers one per lamp  
*Rosetón rectangular 18,89"x9,44" - H.1,18" con dos salidas | con dos controladores con marca UL, uno por lámpara*

**U0979/2.** \_ \_

- .01  White - Blanco
- .02  Black - Negro







INDOOR

# Stick

Design ABS Studio



Suspension lamp characterized by a high direct and punctual luminous efficiency with brass body, internal aluminum heat sink, 48° optical opening, and 98.5" power cable. The essential shape and size make Stick suitable for spotlighting on small tables, peninsulas or, arranged in groups of several elements, to illuminate hotel and office reception desks or large tables.

*Lámpara de suspensión caracterizada por un alto rendimiento luminoso directo y preciso con cuerpo de latón, disipador térmico interno de aluminio, apertura óptica de 48° y cable de alimentación de 98.5". La forma y las dimensiones esenciales hacen que Stick sea adecuado para iluminar mesas pequeñas, penínsulas o, dispuesto en grupos de varios elementos, para iluminar mostradores de recepción de hoteles y oficinas o mesas grandes.*



# Stick system

Design ABS Studio



2 displacement elements included  
2 elementos de descentralización incluidos

**U1580.**\_\_ / \_\_ 1.98 lb

- .01**  White - Blanco
- .02**  Black - Negro
- .21**  Shiny golded - Oro brillante
- .25**  Golded satin - Oro satinado



		Optic degree			
<b>/W</b>	<b>/48</b>	LED 6,1W 350mA	17,3V	975lm	4000K
<b>/W</b>	<b>/ST</b>	LED 6,1W 350mA	17,3V	975lm	4000K
<b>/WW</b>	<b>/48</b>	LED 6,1W 350mA	17,3V	939lm	3000K
<b>/WW</b>	<b>/ST</b>	LED 6,1W 350mA	17,3V	939lm	3000K
<b>/XW</b>	<b>/48</b>	LED 6,1W 350mA	17,3V	896lm	2700K
<b>/XW</b>	<b>/ST</b>	LED 6,1W 350mA	17,3V	896lm	2700K

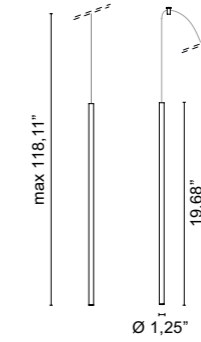

**U1581.**\_\_ / \_\_ 2.20 lb

- .01**  White - Blanco
- .02**  Black - Negro
- .21**  Shiny golded - Oro brillante
- .25**  Golded satin - Oro satinado



		Optic degree			
<b>/W</b>	<b>/48</b>	LED 6,1W 350mA	17,3V	975lm	4000K
<b>/W</b>	<b>/ST</b>	LED 6,1W 350mA	17,3V	975lm	4000K
<b>/WW</b>	<b>/48</b>	LED 6,1W 350mA	17,3V	939lm	3000K
<b>/WW</b>	<b>/ST</b>	LED 6,1W 350mA	17,3V	939lm	3000K
<b>/XW</b>	<b>/48</b>	LED 6,1W 350mA	17,3V	896lm	2700K
<b>/XW</b>	<b>/ST</b>	LED 6,1W 350mA	17,3V	896lm	2700K

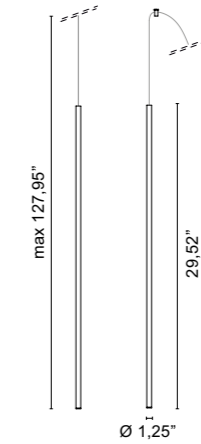

**U1582.**\_\_ / \_\_ 2.43 lb

- .01**  White - Blanco
- .02**  Black - Negro
- .21**  Shiny golded - Oro brillante
- .25**  Golded satin - Oro satinado



		Optic degree			
<b>/W</b>	<b>/48</b>	LED 6,1W 350mA	17,3V	975lm	4000K
<b>/W</b>	<b>/ST</b>	LED 6,1W 350mA	17,3V	975lm	4000K
<b>/WW</b>	<b>/48</b>	LED 6,1W 350mA	17,3V	939lm	3000K
<b>/WW</b>	<b>/ST</b>	LED 6,1W 350mA	17,3V	939lm	3000K
<b>/XW</b>	<b>/48</b>	LED 6,1W 350mA	17,3V	896lm	2700K
<b>/XW</b>	<b>/ST</b>	LED 6,1W 350mA	17,3V	896lm	2700K

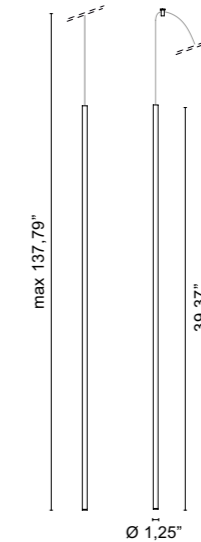

## OPTIONAL



Displacement component  
Elemento de descentralización

**0612** 0.02 lb

- .01**  White - Blanco
- .02**  Black - Negro

## FINISHES CODES - CÓDIGOS DE ACABADOS

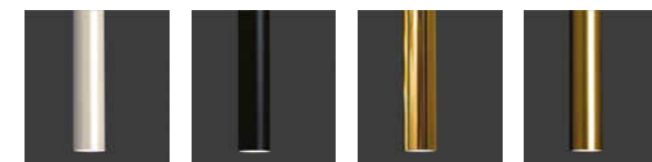

- .01** White Blanco
- .02** Black Negro
- .21** Shiny golded Oro brillante
- .25** Golded satin Oro satinado

Suspension fixing kit and ceiling canopies, power supplies separately ordered  
El kit de montaje en suspensión y las rosetas con fuentes de alimentación deben pedirse por separado

# Stick system

Design ABS Studio



CEILING CANOPY FOR SUSPENSION SYSTEMS 350MA ACCESORIOS Y ROSETAS CON CONTROLADOR UL PARA SISTEMAS DE SUSPENSIÓN DE 350 MA



**IN:** 50/60Hz 100/127V  
**OUT:** 350mA DC



Ceiling canopy for plasterboard with springs and driver | NB from the 3" recessed hole through driver  
*Muelles para cartón yeso incluye | NB el driver pasa por el mismo agujero de 3" a través del conductor*

**U0970.** \_\_

- .01  White - Blanco
- .02  Black - Negro



**IN:** 50/60Hz 100/127V  
**OUT:** 350mA DC



Round canopy D.7,9" - H.1,2" with central outlet. | on UL-marked driver one per lamp  
*Rosetón redondo D.7,9" - H.1,2" con salida central | en controladores con marca UL uno por lámpara*

**U0557/1.** \_\_

- .01  White - Blanco
- .02  Black - Negro



**IN:** 50/60Hz 100/127V  
**OUT:** 350mA DC



Round rosette D.13,8"- H.1,81" with three outlets | with three UL-marked drivers one per lamp  
*Rosetón redondo D.13,8"- H.1,81" con tres salidas | con tres controladores con marca UL, uno por lámpara*

**U0980/3.** \_\_

- .01  White - Blanco
- .02  Black - Negro

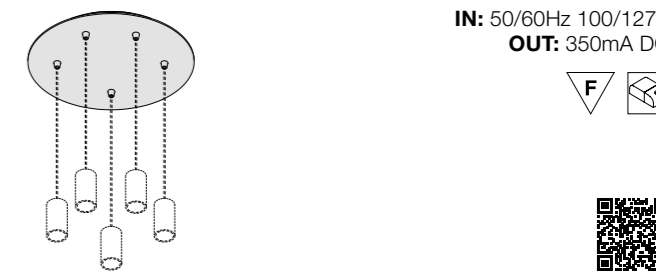

**IN:** 50/60Hz 100/127V  
**OUT:** 350mA DC



Round canopy 18,9"x9,4" - H.1,2" with two outlets. | with two UL-marked drivers one per lamp  
*Rosetón redondo 18,9"x9,4" - H.1,2" con dos salidas | con dos controladores con marca UL, uno por lámpara*

**U0980/5.** \_\_

- .01  White - Blanco
- .02  Black - Negro



**IN:** 50/60Hz 100/127V  
**OUT:** 350mA DC



Round canopy D.7,9" - H.1,2" with two radial outlets | with two UL-marked drivers one per lamp  
*Rosetón redondo D.7,9" - H.1,2" con dos salidas radiales | con dos controladores con marca UL, uno por lámpara*

**U0557/2.** \_\_

- .01  White - Blanco
- .02  Black - Negro



**IN:** 50/60Hz 100/127V  
**OUT:** 350mA DC



Round rosette D.15" - H.1,2" with three radial outlets | with three UL-marked drivers one per lamp  
*Rosetón redondo D.15" - H.1,2" con tres salidas radiales | con tres controladores con marca UL, uno por lámpara*

**U0557/3.** \_\_

- .01  White - Blanco
- .02  Black - Negro

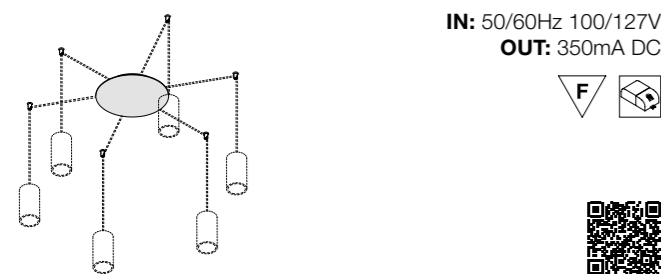

**IN:** 50/60Hz 100/127V  
**OUT:** 350mA DC



Round rosette D.15" - H.1,2" with six radial outlets | with six UL-marked drivers one per lamp  
*Rosetón redondo D.15" - H.1,2" con seis salidas radiales | con seis controladores con marca UL, uno por lámpara*

**U0557/6.** \_\_

- .01  White - Blanco
- .02  Black - Negro



**IN:** 50/60Hz 100/127V  
**OUT:** 350mA DC



Rectangular canopy 18,89"x9,44" - H.1,18" with two outlets. | with two UL-marked drivers one per lamp  
*Rosetón rectangular 18,89"x9,44" - H.1,18" con dos salidas | con dos controladores con marca UL, uno por lámpara*

**U0979/2.** \_\_

- .01  White - Blanco
- .02  Black - Negro

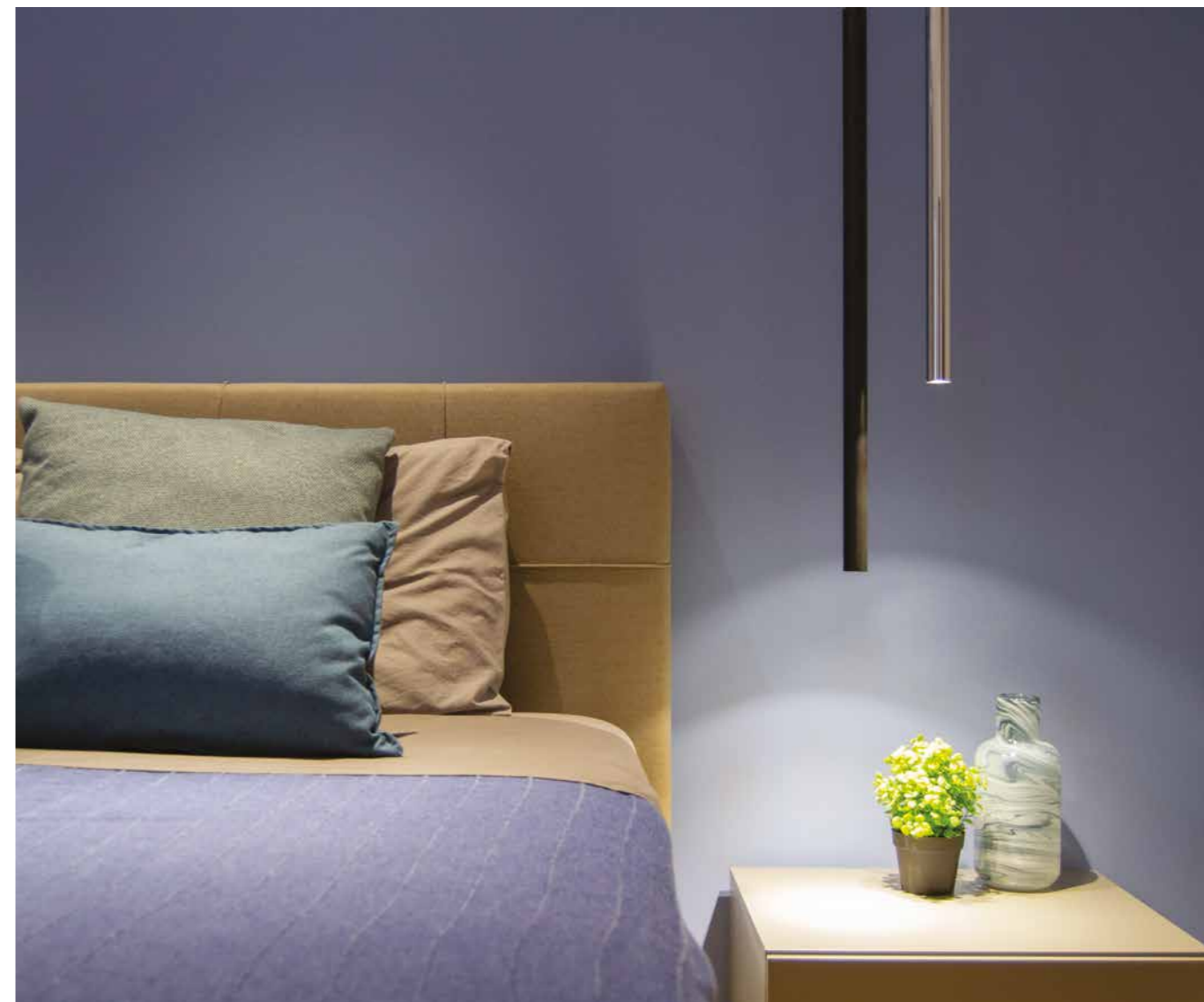



INDOOR

# Linea

Design U.T. EgoLucé



LINEA creates a new way of illuminating and understanding light. A linear lighting system without any interruption. IP40 modular system, with diffused light for recessed installations and small-size structure in coextruded methacrylate. Different modular lengths are possible, from 4,7" up to 118,8", in three shades of light: 2700K, 3000K, and 4000K with CRI>90. Upon request, we prepare fixtures with angled cuts and other light tones.

*LINEA crea una nueva forma de iluminar y entender la luz. Un sistema de iluminación lineal ininterrumpido. Sistema modular IP40, con luz difusa para empotrar y pequeña estructura de metacrilato coextrusionado. Son posibles diferentes longitudes modulares, de 4.7" a 118.8", en tres colores de luz: 2700K, 3000K y 4000K con CRI>90. Bajo pedido, preparamos luminarias con cortes en ángulo y otros colores de luz.*



**Linea**

Design U.T. EGOLUCE



# Linea

Design U.T. EGOLUCE

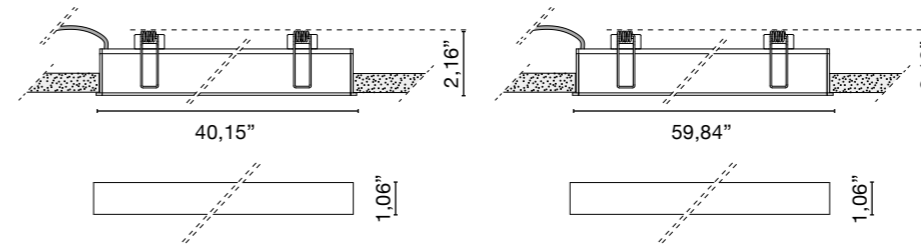

**6615**... / ... 1.10 lb

**.01** White - Blanco

<b>/W</b>	4000K	LED 15W CRI>90	1840lm
<b>/WW</b>	3000K	LED 15W CRI>90	1650lm
<b>/XW</b>	2700K	LED 15W CRI>90	1560lm



**6616**... / ... 3.31 lb

**.01** White - Blanco

<b>/W</b>	4000K	LED 22.5W CRI>90	2760lm
<b>/WW</b>	3000K	LED 22.5W CRI>90	2475lm
<b>/XW</b>	2700K	LED 22.5W CRI>90	2340lm



## EXAMPLES EJEMPLOS

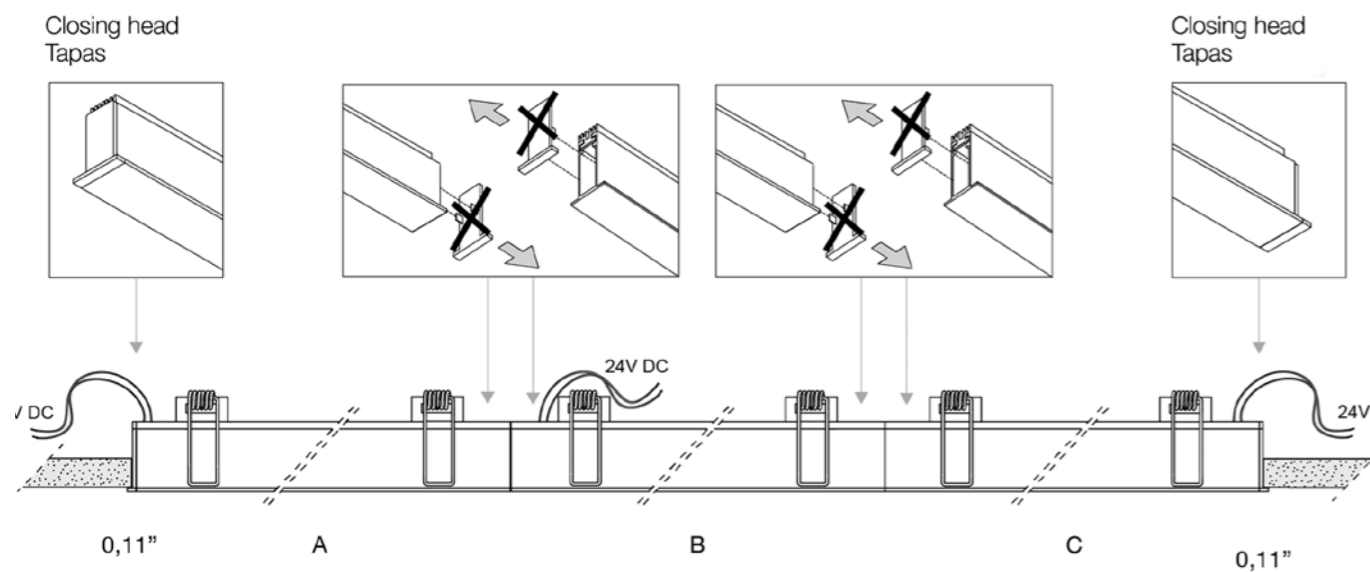

$L = 0,11'' + A + B + C + 0,11''$   
 A B C = Lamps lenght without closing heads. *Longitud de las lámparas sin tapas.*

## CUSTOM SIZE

inches	watt	2700K (XW)	lm	3000K (WW)	lm	4000K (W)	lm
4.72"	1.5W	A6615.01/10/XW	156	A6615.01/10/WW	165	A6615.01/10/W	184
8.66"	3W	A6615.01/20/XW	312	A6615.01/20/WW	330	A6615.01/20/W	368
12.60"	4.5W	A6615.01/30/XW	468	A6615.01/30/WW	495	A6615.01/30/W	552
16.54"	6W	A6615.01/40/XW	624	A6615.01/40/WW	660	A6615.01/40/W	736
20.47"	7.5W	A6615.01/50/XW	780	A6615.01/50/WW	825	A6615.01/50/W	920
24.41"	9W	A6615.01/60/XW	936	A6615.01/60/WW	990	A6615.01/60/W	1104
28.35"	10.5W	A6615.01/70/XW	1092	A6615.01/70/WW	1155	A6615.01/70/W	1288
32.28"	12W	A6615.01/80/XW	1248	A6615.01/80/WW	1320	A6615.01/80/W	1472
36.22"	13.5W	A6615.01/90/XW	1404	A6615.01/90/WW	1485	A6615.01/90/W	1656
40.16"	15W	6615.01/XW *	1560	6615.01/WW *	1650	6615.01/W *	1840
44.09"	16.5W	A6615.01/110/XW	1716	A6615.01/110/WW	1815	A6615.01/110/W	2024
48.03"	18W	A6615.01/120/XW	1872	A6615.01/120/WW	1980	A6615.01/120/W	2208
51.97"	19.5W	A6615.01/130/XW	2028	A6615.01/130/WW	2145	A6615.01/130/W	2392
55.91"	21W	A6615.01/140/XW	2184	A6615.01/140/WW	2310	A6615.01/140/W	2576
59.84"	22.5W	6616.01/XW *	2340	6616.01/WW *	2475	6616.01/W *	2760
63.78"	24W	A6615.01/160/XW	2496	A6615.01/160/WW	2640	A6615.01/160/W	2944
67.72"	25.5W	A6615.01/170/XW	2652	A6615.01/170/WW	2805	A6615.01/170/W	3128
71.65"	27W	A6615.01/180/XW	2808	A6615.01/180/WW	2970	A6615.01/180/W	3312
75.59"	28.5W	A6615.01/190/XW	2964	A6615.01/190/WW	3135	A6615.01/190/W	3496
79.53"	30W	A6615.01/200/XW	3120	A6615.01/200/WW	3300	A6615.01/200/W	3680
83.46"	31.5W	A6615.01/210/XW	3276	A6615.01/210/WW	3465	A6615.01/210/W	3864
87.40"	33W	A6615.01/220/XW	3432	A6615.01/220/WW	3630	A6615.01/220/W	4048
91.34"	34.5W	A6615.01/230/XW	3588	A6615.01/230/WW	3795	A6615.01/230/W	4232
95.28"	36W	A6615.01/240/XW	3744	A6615.01/240/WW	3960	A6615.01/240/W	4416
99.21"	37.5W	A6615.01/250/XW	3900	A6615.01/250/WW	4125	A6615.01/250/W	4600

# Linea

Design U.T. EGOLUCE



## ACCESSORIES ACCESORIOS

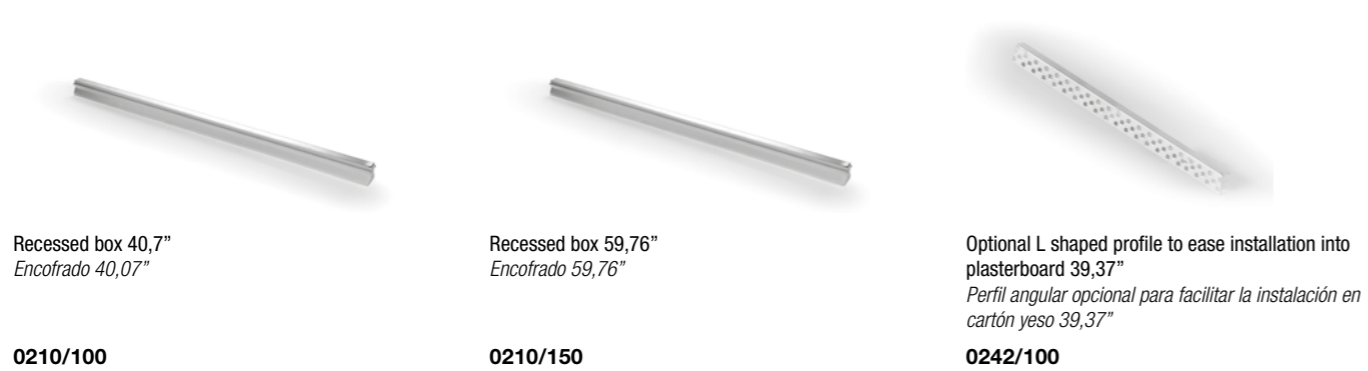

Recessed box 40,7"  
Encofrado 40,07"

**0210/100**

Recessed box 59,76"  
Encofrado 59,76"

**0210/150**

Optional L shaped profile to ease installation into  
plasterboard 39,37"  
Perfil angular opcional para facilitar la instalación en  
cartón yeso 39,37"

**0242/100**

## DRIVERS CONDUCTORES

**U0160/24**

IN:120-277V OUT:24V-60W

**U0161/24**

IN:120-277V OUT:24V-100W



**Linea**

Design U.T. EGOLUCE



Project Studio Keyart Milano



Project Studio Keyart Milano

**Linea**

Design U.T. EGOLUCE



Ph. Flavio Ricci



INDOOR / OUTDOOR

# Joy

Design: Officina di Architettura e Design



The IP65 lamp collection is characterized by a variety of accessories and sources that can help you create countless lighting solutions for any aesthetic or lighting technology need. By assembling the individual parts through the joints, you can create: - stakes/poles - wall lamps - path markers - illuminated handrails and so on. Joints of light are the easiest and quickest way to assemble your lamp according to your ideas and needs.

*La colección de lámparas IP65 se caracteriza por una gran variedad de accesorios y fuentes de luz que permiten crear innumerables soluciones de iluminación para cualquier requisito estético o lumínico. Al ensamblar las piezas individuales mediante juntas, es posible crear - postes - lámparas de pared - marcadores de ruta - pasamanos iluminados, etc. Las uniones ligeras son la forma más rápida y sencilla de montar su lámpara según sus ideas y requisitos.*

# Joy

Design Officina di Architettura e Design

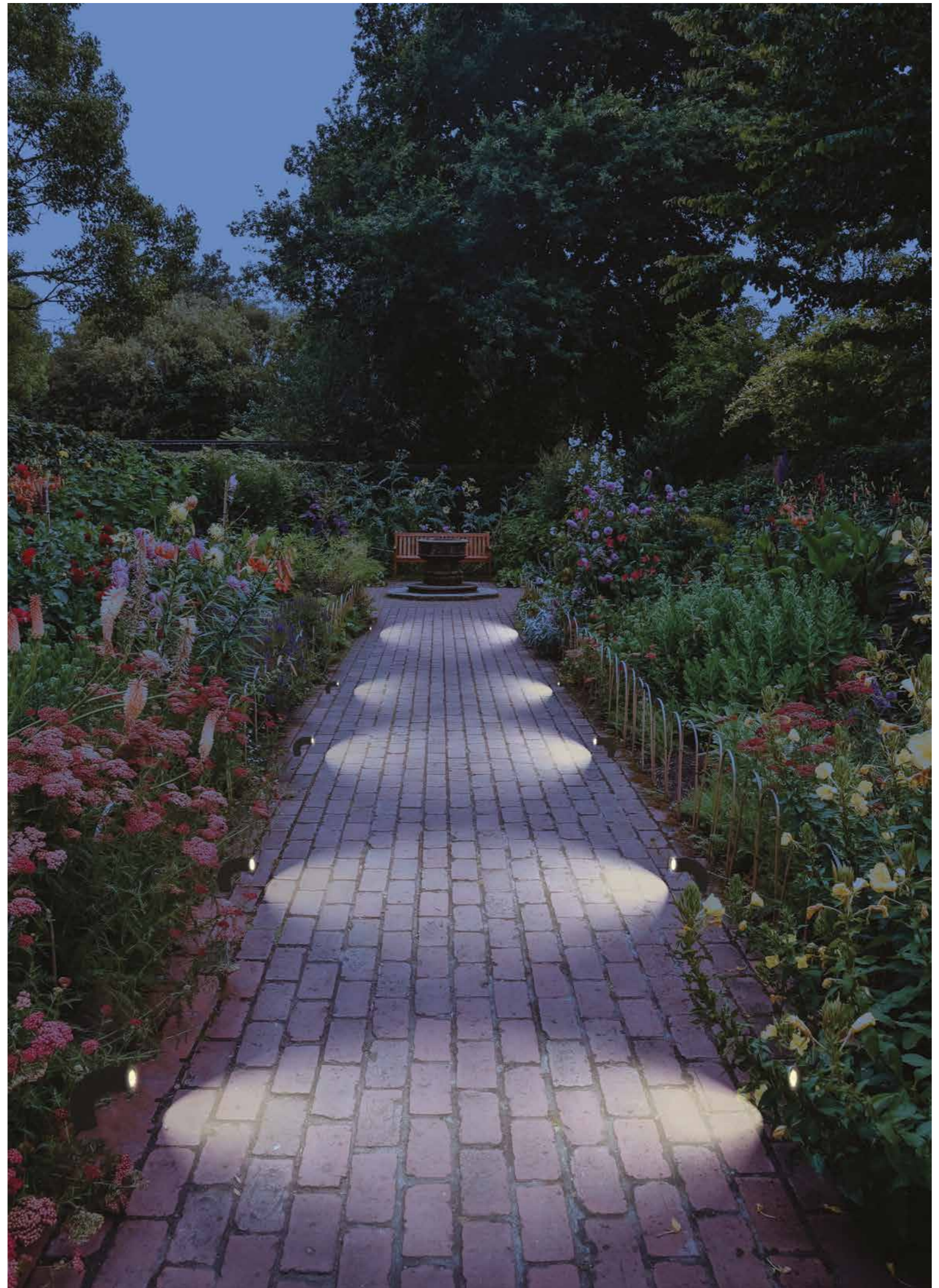



## Joy

Design Officina di Architettura e Design

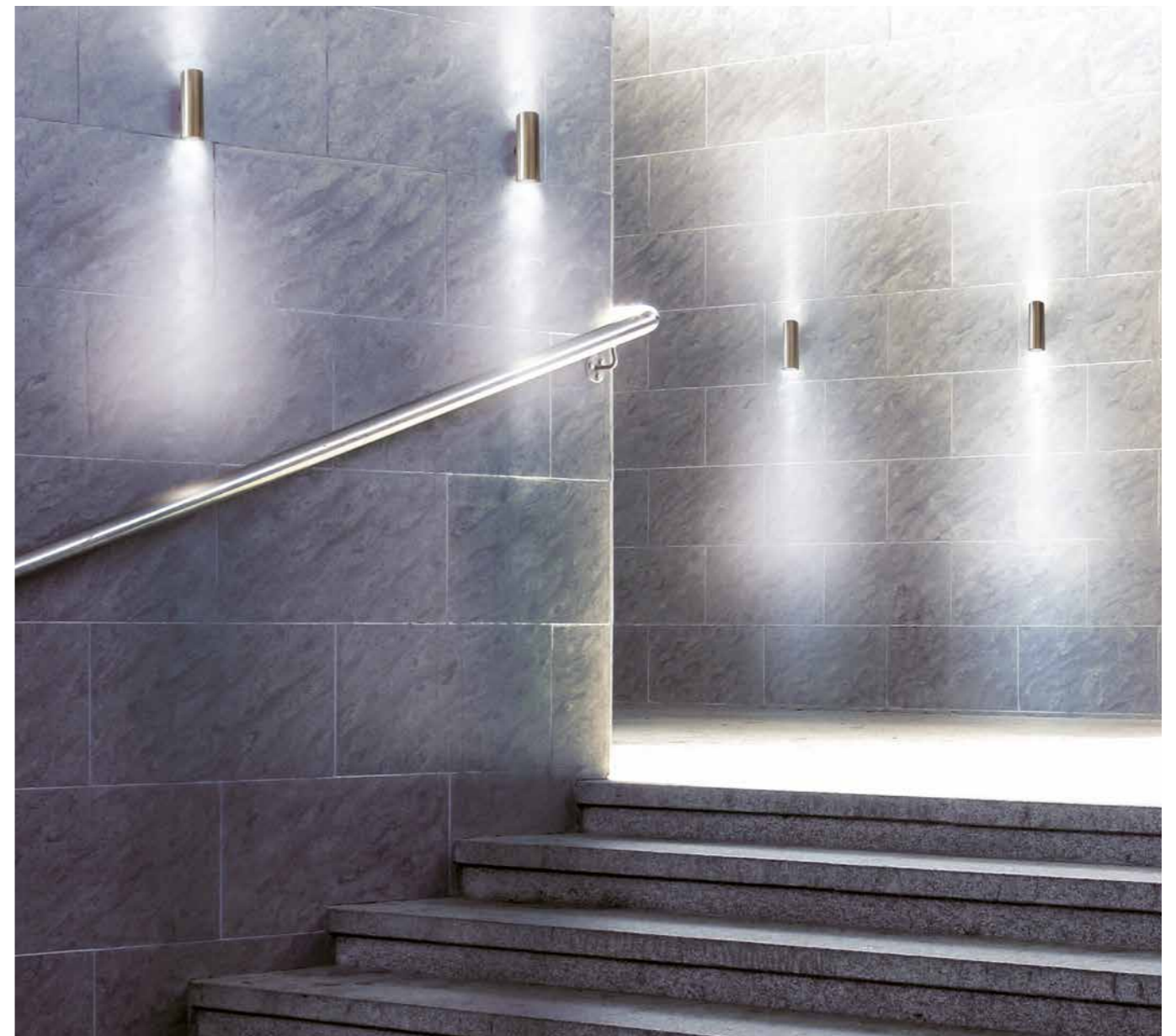
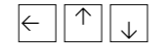

# Joy

Design Officina di Architettura e Design

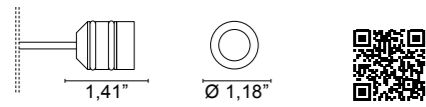

7516.\_ \_ / \_ \_ 0.18 lb

.45 ■ Aluminium anodized - *Aluminio anodizado*

/W 4000K LED MAX 1,5W CRI>90 500mA 221lm

/WW 3000K LED MAX 1,5W CRI>90 500mA 210lm

/XW 2700K LED MAX 1,5W CRI>90 500mA 199lm



## SYSTEM ELEMENTS ELEMENTOS DEL SISTEMA

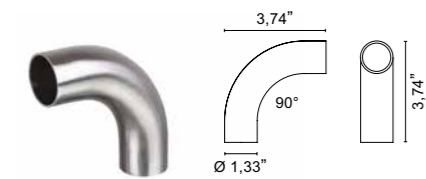

90° expanding bend  
*Curva de mandril de 90°*

7500.\_ \_

- .01 ■ White - *Blanco*
- .02 ■ Black - *Negro*
- .06 ■ Green - *Verde*
- .33 ■ Stainless steel AISI 316L - *Acero cepillado*
- .34 ■ Painted corten finishing - *Corten pintado*

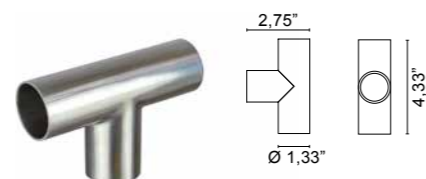

T joint expanding bend  
*Junta en T con mandril*

7501.\_ \_

- .01 ■ White - *Blanco*
- .02 ■ Black - *Negro*
- .06 ■ Green - *Verde*
- .33 ■ Stainless steel AISI 316L - *Acero cepillado*
- .34 ■ Painted corten finishing - *Corten pintado*



45° expanding bend  
*Curva de sujeción de 45*

7504.\_ \_

- .01 ■ White - *Blanco*
- .02 ■ Black - *Negro*
- .06 ■ Green - *Verde*
- .33 ■ Stainless steel AISI 316L - *Acero cepillado*
- .34 ■ Painted corten finishing - *Corten pintado*

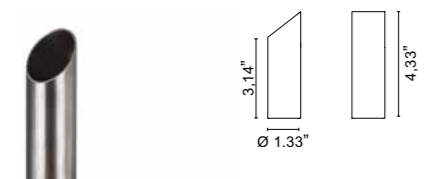

Joint with 45°  
*Junta cortada a 45*

7505.\_ \_

- .01 ■ White - *Blanco*
- .02 ■ Black - *Negro*
- .06 ■ Green - *Verde*
- .33 ■ Stainless steel AISI 316L - *Acero cepillado*
- .34 ■ Painted corten finishing - *Corten pintado*



Linear tube  
*Tubo lineal*

7508.\_ \_ / \_ \_

- .01 ■ White - *Blanco*
- .02 ■ Black - *Negro*
- .06 ■ Green - *Verde*
- .33 ■ Stainless steel AISI 316L - *Acero cepillado*
- .34 ■ Painted corten finishing - *Corten pintado*

/20 7,87"

/50 19,68"

/100 39,37"

/150 59,05"

## ACCESSORIES ACCESORIOS

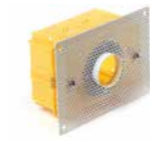

Kit: box + perforated plaster  
*Kit: caja + yeso perforado*

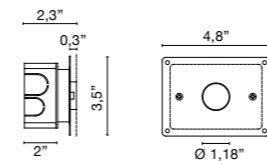

0213



Plastic Box  
*Caja de plastico*

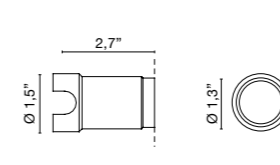

0216



Draining box  
*Encofrado drenante*

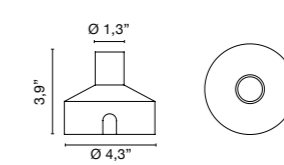

0228/R



Box + plate with steel screws  
*Caja + placa con tornillos de acero*

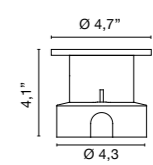

0246/R



Junction element  
*Elemento de unión*

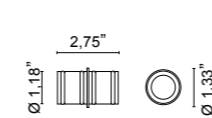

7510.\_ \_

- .02 ■ Black - *Negro*



Aluminium wall base with cover disc  
*Base mural de aluminio con disco de cubierta de base*

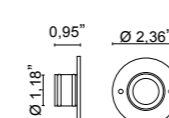

7521.\_ \_

- .01 ■ White - *Blanco*
- .02 ■ Black - *Negro*
- .06 ■ Green - *Verde*
- .33 ■ Stainless steel AISI 316L - *Acero cepillado*
- .34 ■ Painted corten finishing - *Corten pintado*



Base with cover disc  
*Base con disco de cubierta de base*



7522.\_ \_

- .01 ■ White - *Blanco*
- .02 ■ Black - *Negro*
- .06 ■ Green - *Verde*
- .33 ■ Stainless steel AISI 316L - *Acero cepillado*
- .34 ■ Painted corten finishing - *Corten pintado*

## DRIVERS CONDUCTORES

0127	Drivers 500 mA - 1-6 Spot
0145	Multi-power dimmable driver PUSH - 1...10V - 1-21 Spot
0141/DIM	Multi-power dimmable driver PUSH - 1...10V - 1-11 Spot

0128	Drivers 350 mA - 1-10 Spot
0141/DALI	Multi-power dimmable driver PUSH - 1...10V - 1-11 Spot
0145/DALI	Multi-power DALI dimmable driver - 1-21 Spot

## FINISHES CODES - CÓDIGOS DE ACABADOS



.01 White *Blanco* .02 Black *Negro* .06 Green *Verde* .33 Stainless steel AISI 316L *Acero cepillado* .34 Painted corten finishing *Corten pintado*

# Joy

Design Officina di Architettura e Design

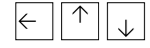

EXAMPLES OF CONFIGURATIONS EJEMPLOS DE CONFIGURACIONES

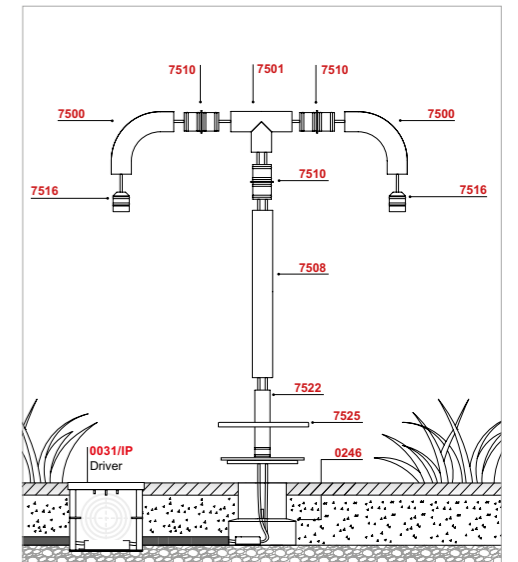
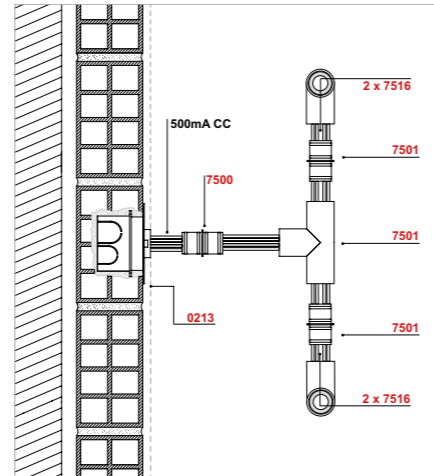
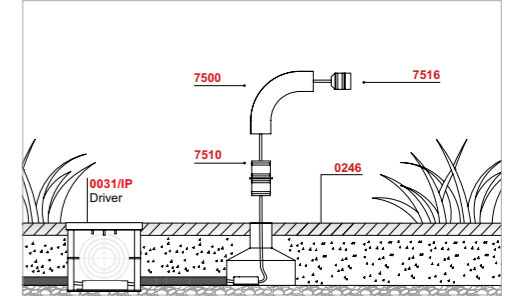
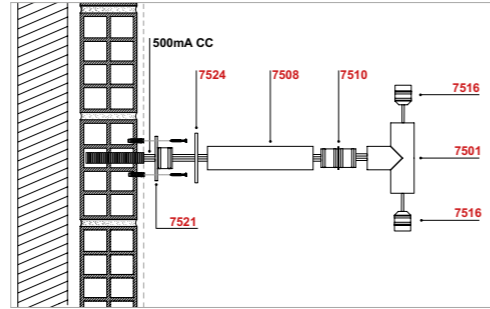

# Joy

Design Officina di Architettura e Design

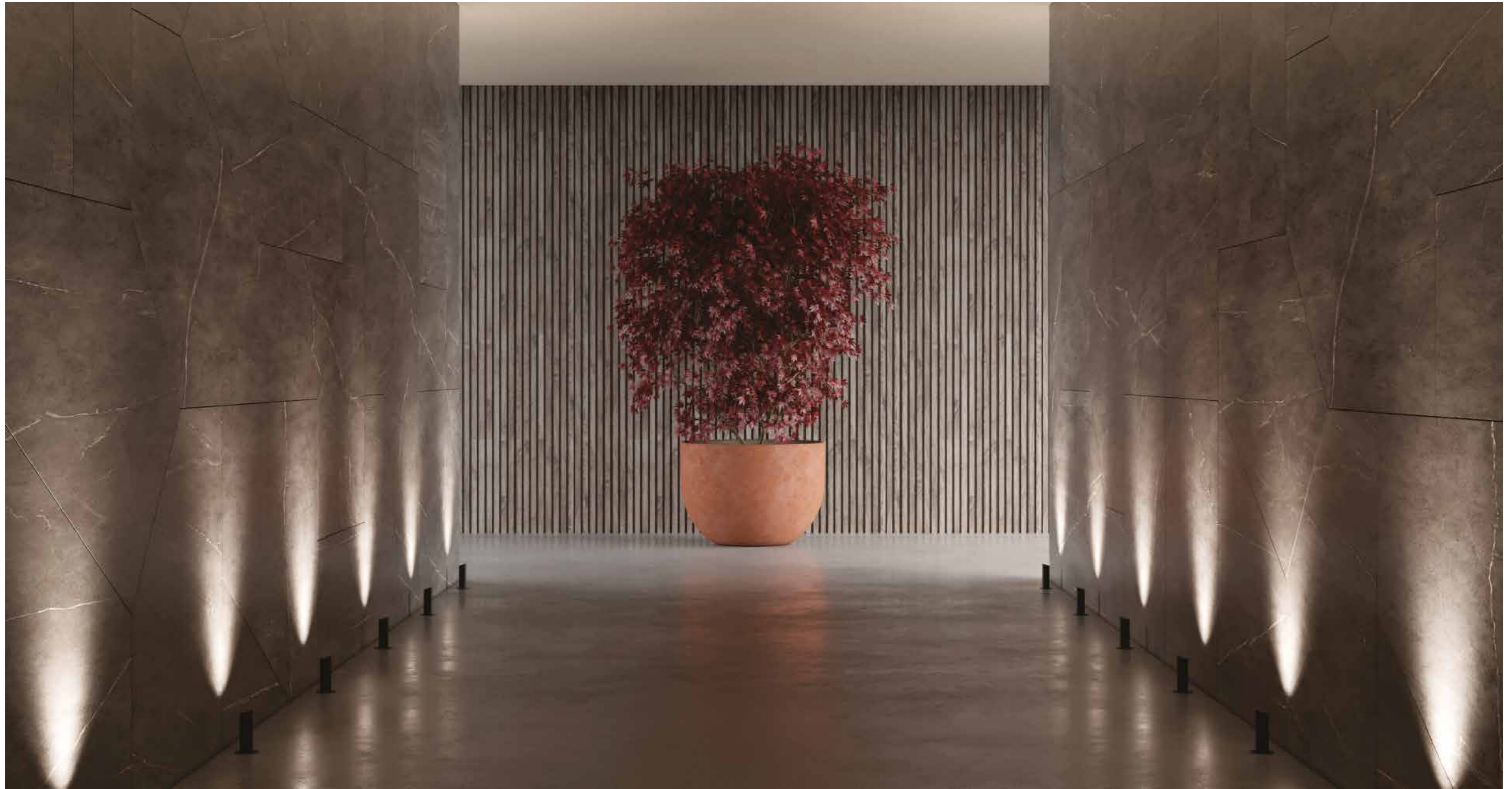
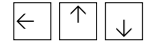



# Joy

Design Officina di Architettura e Design

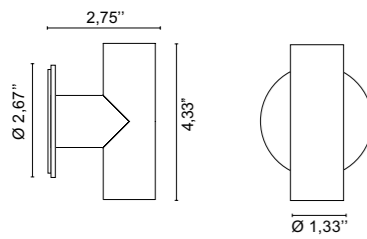

4672. \_ \_ / \_ \_ 0.68 lb

- .01  White - Blanco
- .02  Black - Negro
- .06  Green - Verde
- .33  Stainless steel AISI 316L - Acero cepillado
- .34  Painted corten finishing - Corten pintado

/W	4000K	LED 3W	500mA	442lm
/WW	3000K	LED 3W	500mA	420lm
/XW	2700K	LED 3W	500mA	398lm

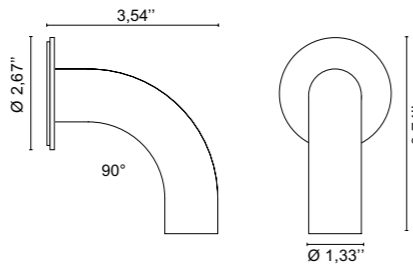

4673. \_ \_ / \_ \_ 0.55 lb

- .01  White - Blanco
- .02  Black - Negro
- .06  Green - Verde
- .33  Stainless steel AISI 316L - Acero cepillado
- .34  Painted corten finishing - Corten pintado

/W	4000K	LED 1.5W	500mA	221lm
/WW	3000K	LED 1.5W	500mA	210lm
/XW	2700K	LED 1.5W	500mA	199lm

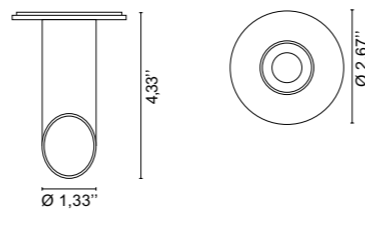

5690. \_ \_ / \_ \_ 0.55 lb

- .01  White - Blanco
- .02  Black - Negro
- .06  Green - Verde
- .33  Stainless steel AISI 316L - Acero cepillado
- .34  Painted corten finishing - Corten pintado

/W	4000K	LED 1.5W	500mA	221lm
/WW	3000K	LED 1.5W	500mA	210lm
/XW	2700K	LED 1.5W	500mA	199lm



## DRIVERS CONDUCTORES

### 0127

4672	1-3 pcs
4673	1-6 pcs
5690	1-6 pcs

Only serial connection - Solo conexión serie

# Joy

Design Officina di Architettura e Design

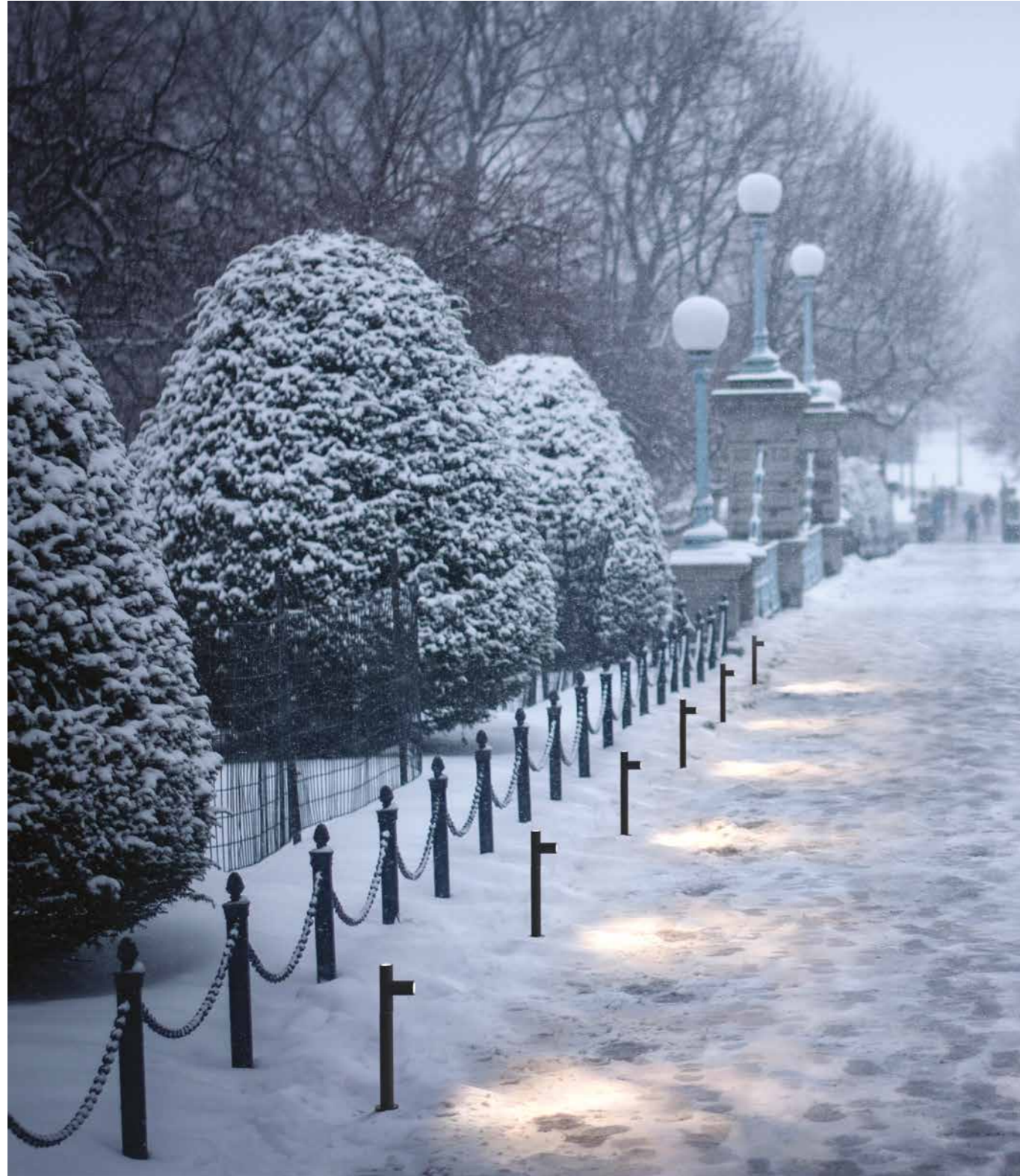

# Joy

Design Officina di Architettura e Design

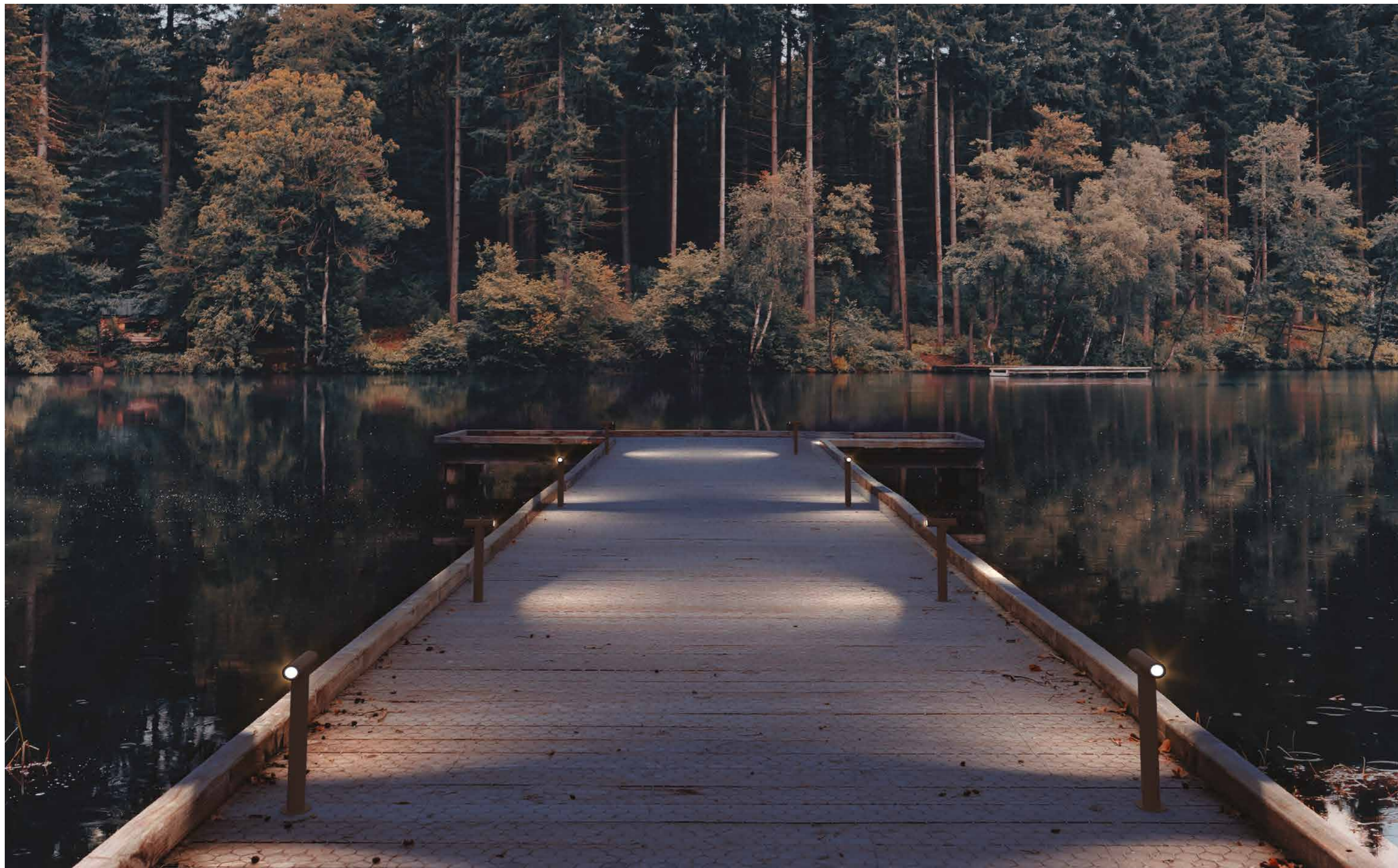
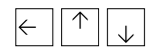

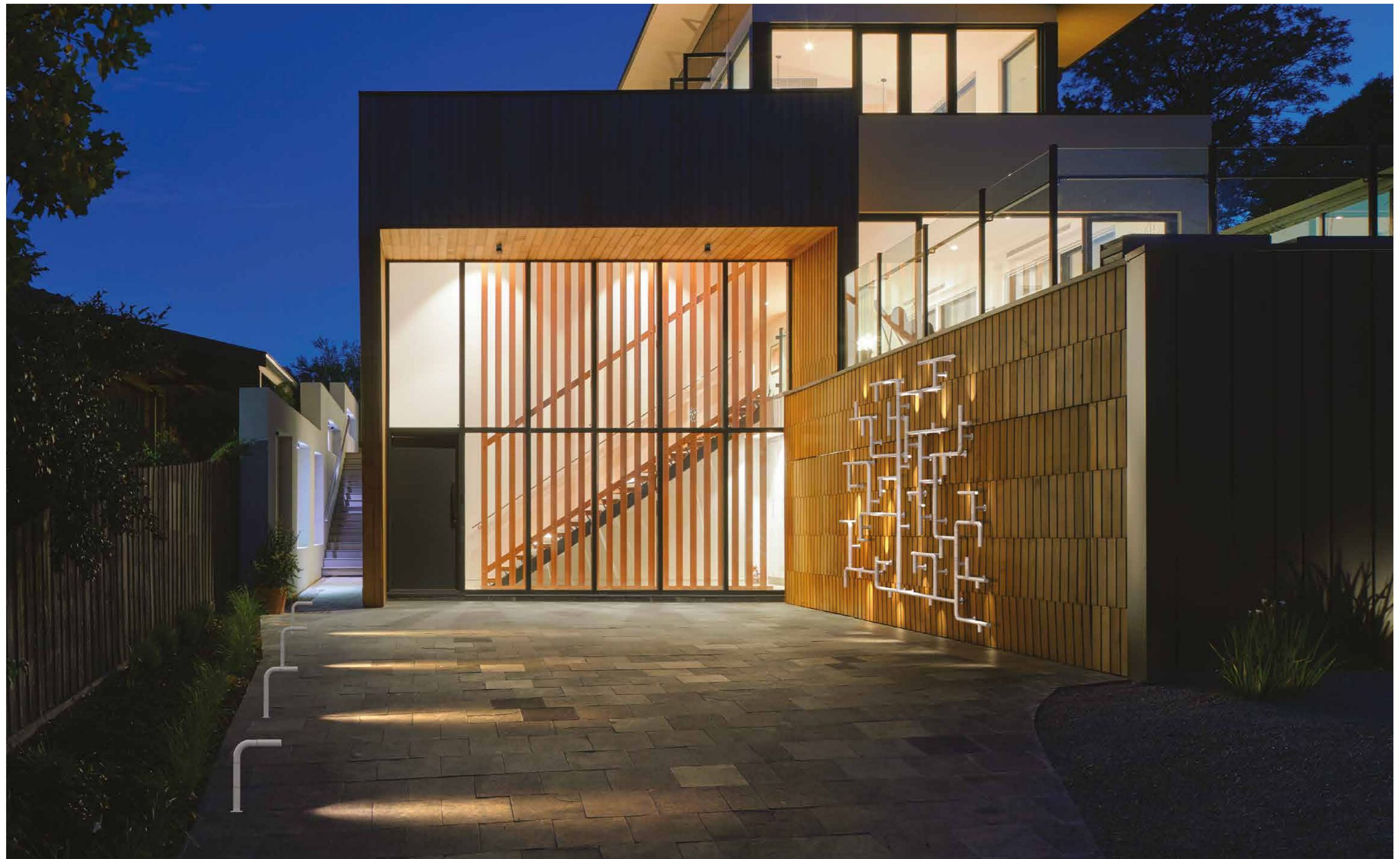
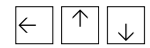

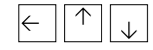

EXAMPLES OF CONFIGURATIONS EJEMPLOS DE CONFIGURACIONES

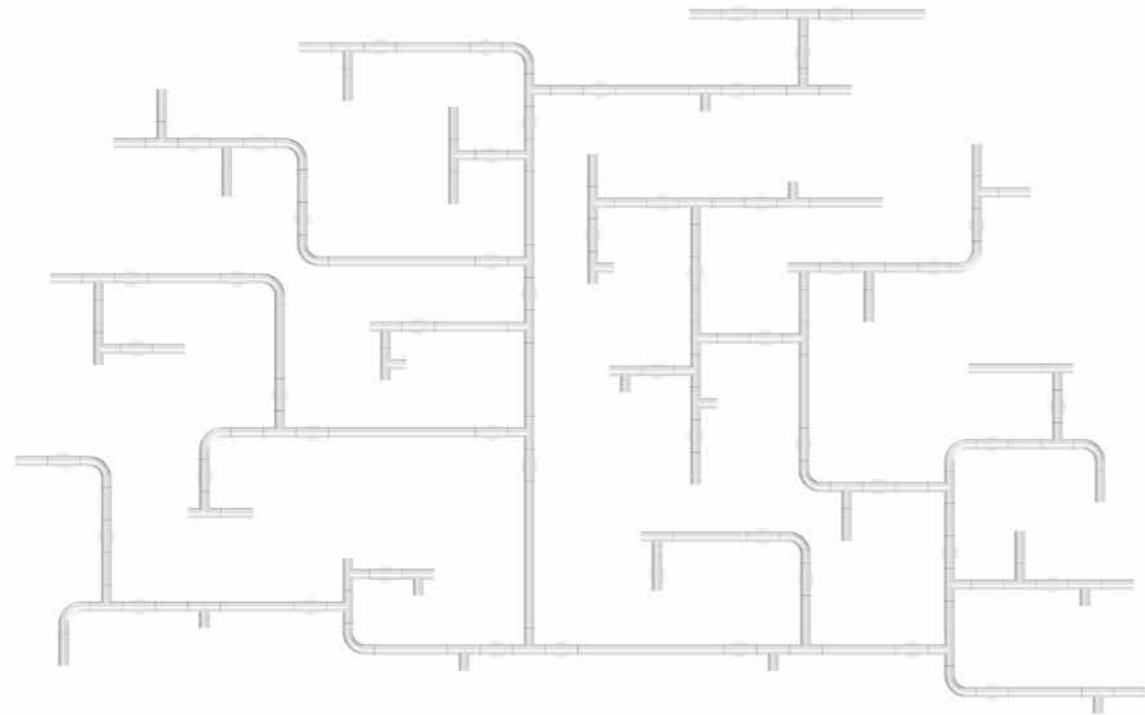

01 The light dispenser

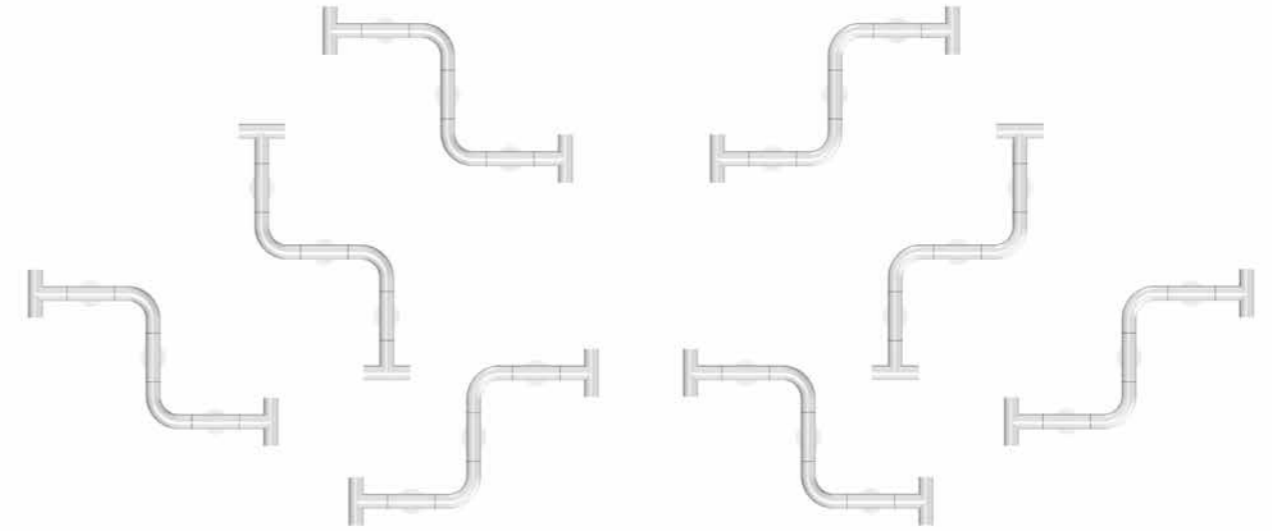

03 Medusa

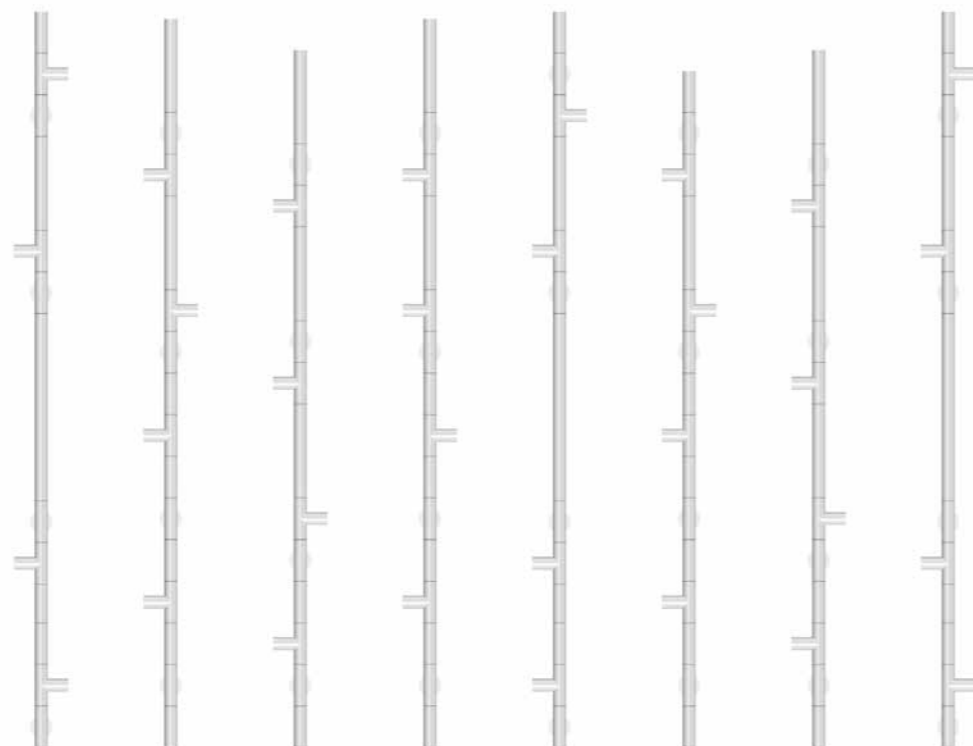

02 Forest of light

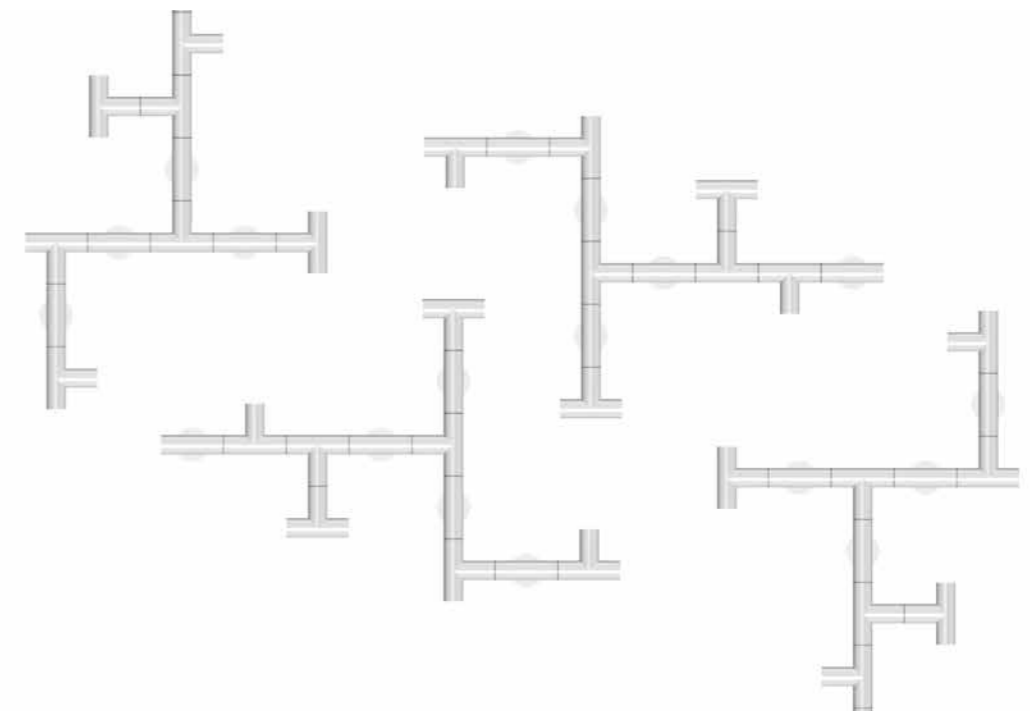

04 Swing

The minimal design combined with the innovative technology of the battery-powered portable luminaire, makes Lara an elegant and functional product. The multipurpose luminaire reflector can be used in various applications. Whether a floor, table clamp, ground stake, or rope to hang, there is no limit to your creativity. Lara can be charged a USB-C cable, with 11 hours battery life at 100% luminosity.

*El diseño minimalista combinado con la innovadora tecnología de la luminaria portátil alimentada por pilas hace de Lara un producto elegante y funcional. El reflector polivalente de la luminaria puede utilizarse en diversas aplicaciones. Ya sea una abrazadera de suelo, de mesa, una estaca en el suelo o una cuerda para colgar, no hay límite para su creatividad. Lara se puede cargar con un cable USB-C, con una autonomía de 11 horas al 100% de luminosidad.*

INDOOR / OUTDOOR

# Lara

Design Serge Cornelissen



# Lara

Design Serge Cornelissen





# Lara

Design Serge Cornelissen

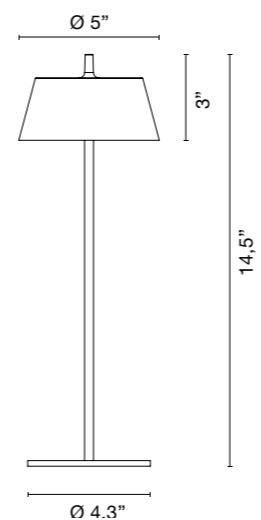
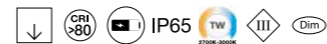

2550. \_ \_ 1.43 lb

- .02 ■ Black - *Negro*
- .06 ■ Green - *Verde*
- .34 ■ Painted corten finishing - *Corten pintado*
- .39 ■ Painted Anthracite finishing - *Pintado antracita*

2700-3000K LED 2.2W 120lm



2700-3000K

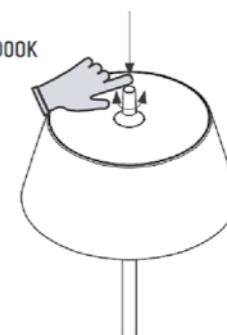

## FINISHES CODES - CÓDIGOS DE ACABADOS

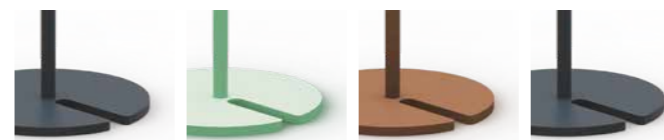

- .02 Black *Negro*
- .06 Green *Verde*
- .34 Rust Brown *Corten*
- .39 Anthracite *Antracita*





# Lara Maxi

Design Serge Cornelissen

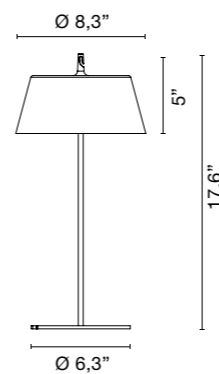

2552.02/\_ \_ 3.37 lb

.02 ■ Black - Negro

/WW 3000K LED 3.5W 140lm

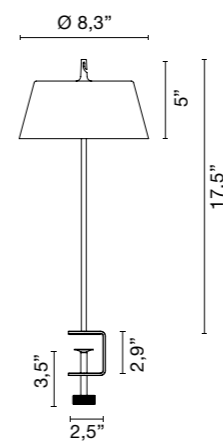

2553.02/\_ \_ 2.03 lb

.02 ■ Black - Negro

/WW 3000K LED 3.5W 140lm





## Lara Maxi

Design Serge Cornelissen

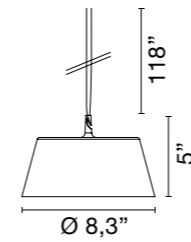

1690. \_ \_ / \_ \_ 1.54 lb

.02 ■ Black - *Negro*

.05 ■ Red - *Rojo*

/WW 3000K LED 3.5W 140lm



### FINISHES CODES - CÓDIGOS DE ACABADOS



.02 Black  
*Negro*

.05 Red  
*Rojo*

INDOOR / OUTDOOR

# Wanda

Design U.T. EgoIuce



IP67 adjustable light bar for wall and ceiling or suspension applications with diffused light made of transparent anti-UV coextruded methacrylate and terminals in stainless steel. Wanda is offered in different modular lengths from 7.08" up to 117.33 cm and in three shades of light, 2700K, 3000K, and 4000K, with CRI>90. This simple effective illumination offers creative solutions for various environments, from offices and kitchens to outdoor poolside and gardens.

*Barra de luz regulable IP67 para aplicaciones de pared, techo o colgante con luz difusa en metacrilato coextrusionado transparente anti-UV y terminales de acero inoxidable. Wanda está disponible en diferentes longitudes modulares de 7.08" cm a 117.33" y en tres colores de luz, 2700K, 3000K y 4000K, con CRI>90. Esta iluminación sencilla pero eficaz ofrece soluciones creativas para distintos entornos, desde oficinas y cocinas hasta bordes de piscinas y jardines exteriores.*

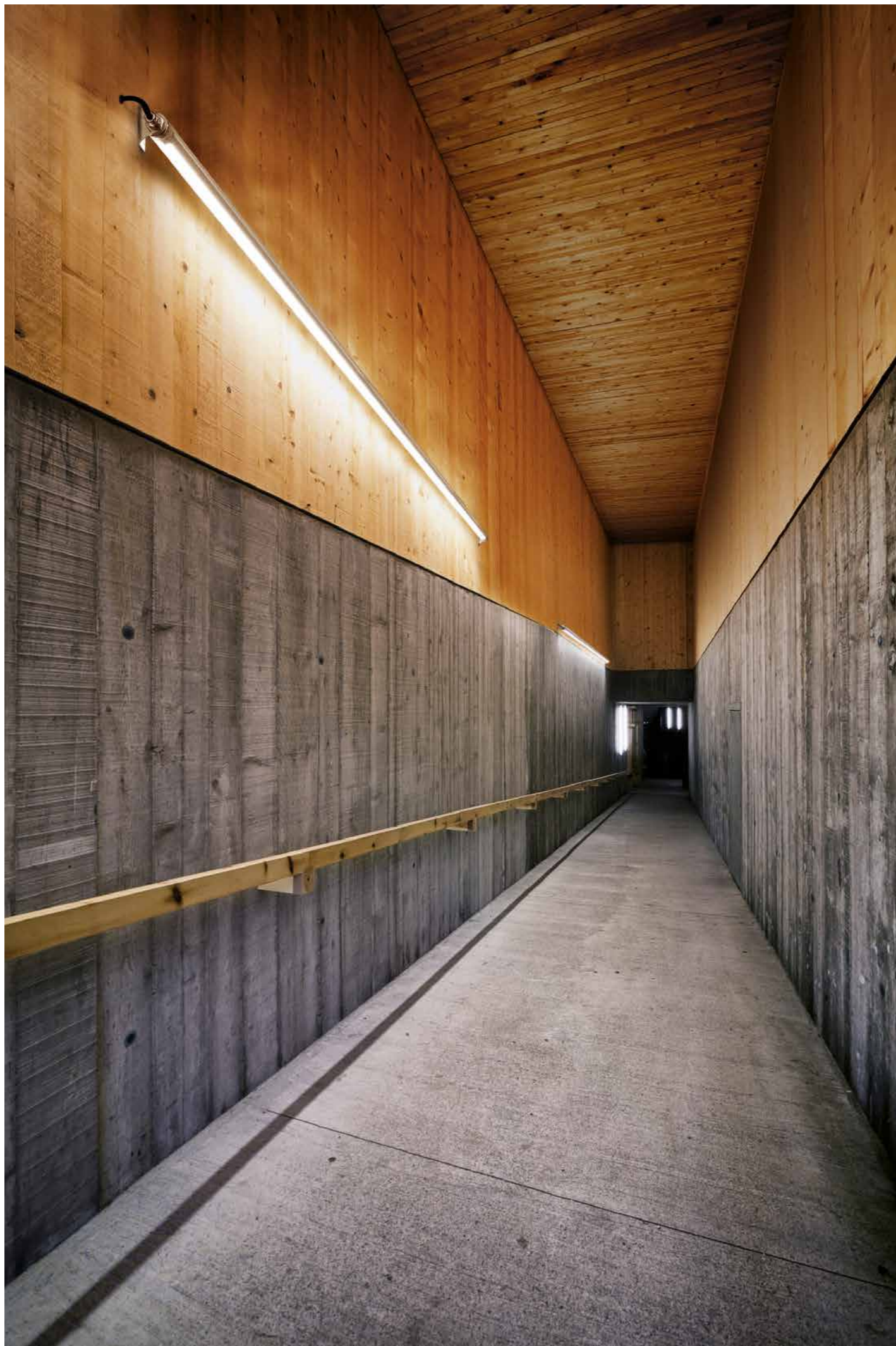

# Wanda

Design U.T. EGOLUCE

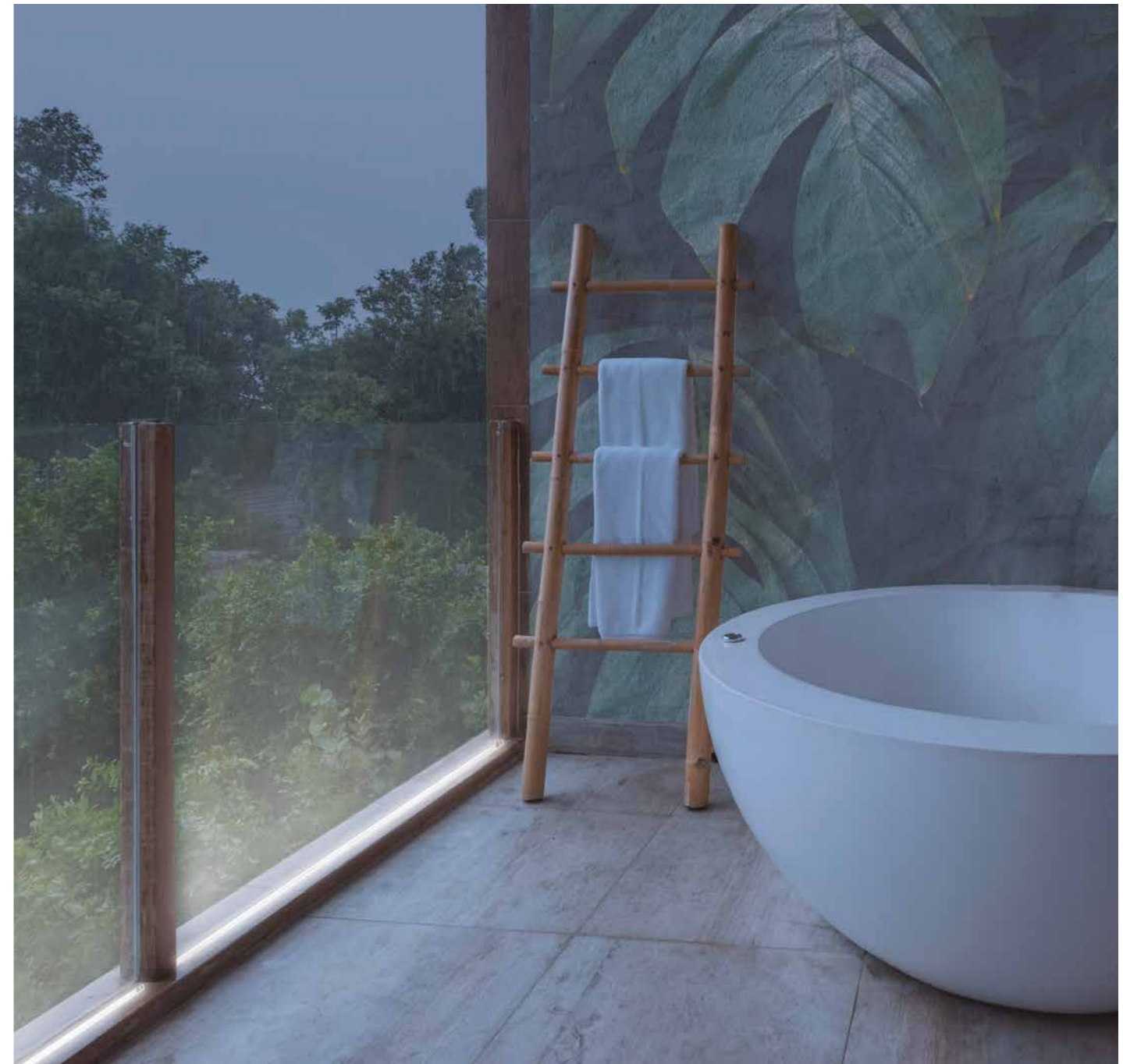

# Wanda

Design U.T. EGOLUCE

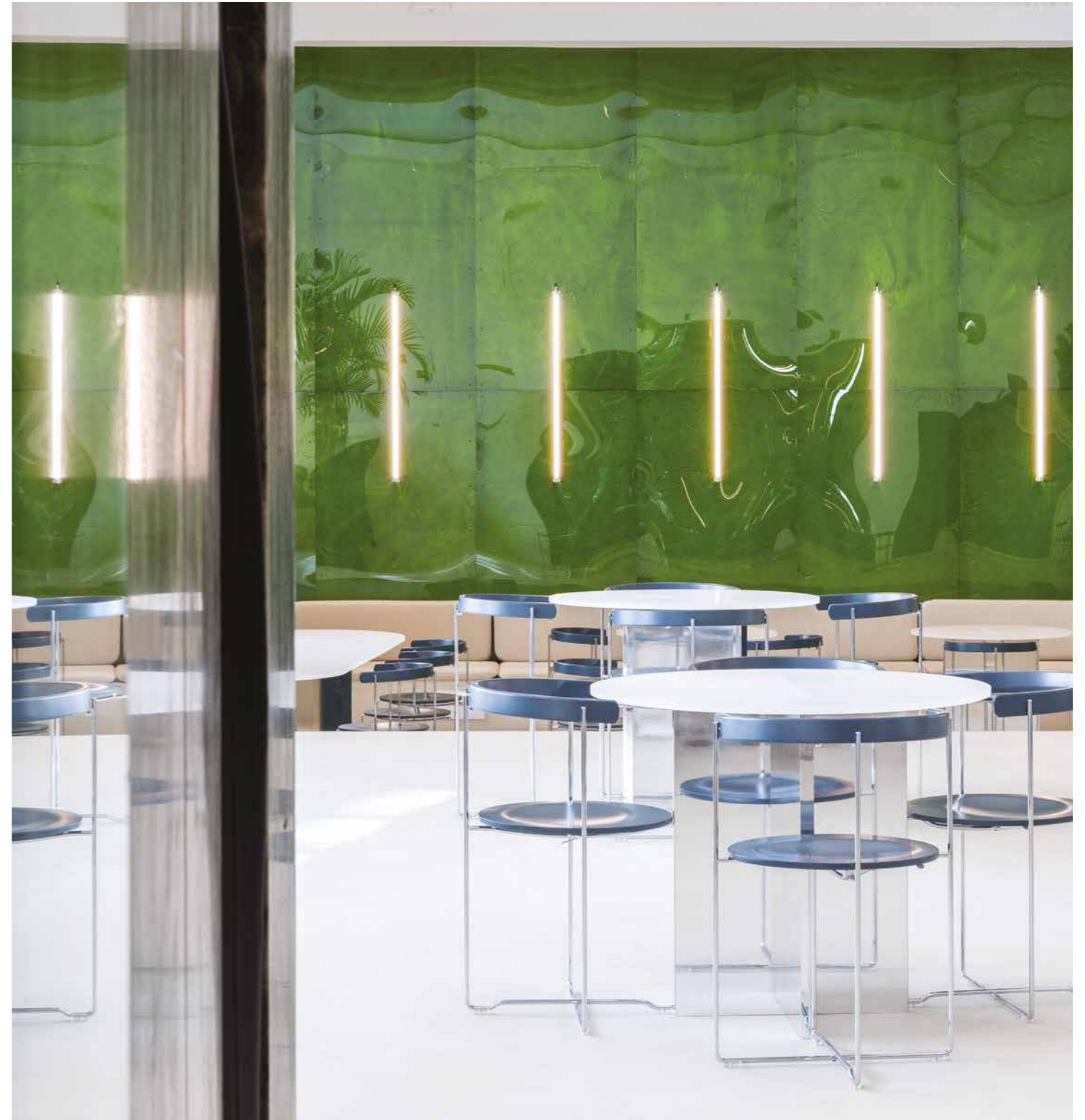
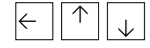

Cobra studios design - HUGUES DELAUNAY & KENNY DECOMMER

# Wanda

Design U.T. EGOLUCE

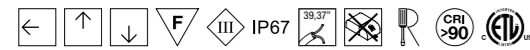

Customized length p.203  
Tamaños especiales p.203

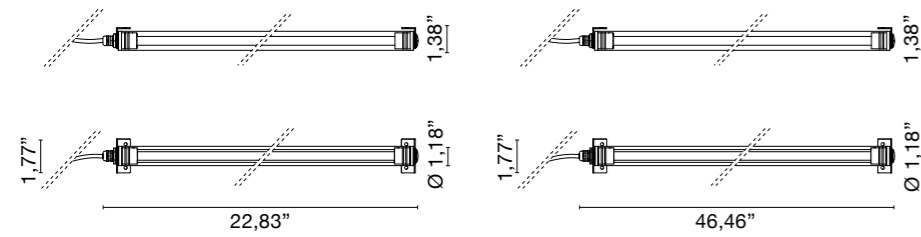

**4536**.\_.\_ / \_.\_ 1.10 lb

**.33** ■ Stainless steel AISI 316L - Acero cepillado

**/W** 4000K LED 7,5W CRI>90 24V 920lm

**/WW** 3000K LED 7,5W CRI>90 24V 825lm

**/XW** 2700K LED 7,5W CRI>90 24V 780lm



**4537**.\_.\_ / \_.\_ 2.20 lb

**.33** ■ Stainless steel AISI 316L - Acero cepillado

**/W** 4000K LED 16,5W CRI>90 24V 2024lm

**/WW** 3000K LED 16,5W CRI>90 24V 1815lm

**/XW** 2700K LED 16,5W CRI>90 24V 1716lm



## DRIVERS CONDUCTORES

**U0160/24**

IN:120-277V OUT:24V-60W

**U0161/24**

IN:120-277V OUT:24V-100W

## CUSTOM SIZE

Table of available lengths. Measures are referred to complete fixtures including closing heads.

Tabla de longitudes disponibles. Las medidas se refieren a la longitud total de las lámparas.

inches	watt	2700K (XW)	lm	3000K (WW)	lm	4000K (W)	lm
7.09"	1,5W	A4536.33/18/XW	156	A4536.33/18/WW	165	A4536.33/18/W	184
11.02"	3W	A4536.33/28/XW	312	A4536.33/28/WW	330	A4536.33/28/W	368
14.96"	4.5W	A4536.33/38/XW	468	A4536.33/38/WW	495	A4536.33/38/W	552
18.90"	6W	A4536.33/48/XW	624	A4536.33/48/WW	660	A4536.33/48/W	736
22.83"	7.5W	4536.33/XW ★	780	4536.33/WW ★	825	4536.33/W ★	920
26.77"	9W	A4536.33/68/XW	936	A4536.33/68/WW	990	A4536.33/68/W	1104
30.71"	10.5W	A4536.33/78/XW	1092	A4536.33/78/WW	1155	A4536.33/78/W	1288
34.65"	12W	A4536.33/88/XW	1248	A4536.33/88/WW	1320	A4536.33/88/W	1472
38.58"	13.5W	A4536.33/98/XW	1404	A4536.33/98/WW	1485	A4536.33/98/W	1656
42.52"	15W	A4536.33/108/XW	1560	A4536.33/108/WW	1650	A4536.33/108/W	1840
46.46"	16.5W	4537.33/XW ★	1716	4537.33/WW ★	1815	4537.33/W ★	2024
50.39"	18W	A4536.33/128/XW	1872	A4536.33/128/WW	1980	A4536.33/128/W	2208
54.33"	19.5W	A4536.33/138/XW	2028	A4536.33/138/WW	2145	A4536.33/138/W	2392
58.27"	21W	A4536.33/148/XW	2184	A4536.33/148/WW	2310	A4536.33/148/W	2576
62.20"	22.5W	A4536.33/158/XW	2340	A4536.33/158/WW	2475	A4536.33/158/W	2760
66.14"	24W	A4536.33/168/XW	2496	A4536.33/168/WW	2640	A4536.33/168/W	2944
70.08"	25.5W	A4536.33/178/XW	2652	A4536.33/178/WW	2805	A4536.33/178/W	3128
74.02"	27W	A4536.33/188/XW	2808	A4536.33/188/WW	2970	A4536.33/188/W	3312
77.95"	28.5W	A4536.33/198/XW	2964	A4536.33/198/WW	3135	A4536.33/198/W	3496
81.89"	30W	A4536.33/208/XW	3120	A4536.33/208/WW	3300	A4536.33/208/W	3680
85.83"	31.5W	A4536.33/218/XW	3276	A4536.33/218/WW	3465	A4536.33/218/W	3864
89.76"	33W	A4536.33/228/XW	3432	A4536.33/228/WW	3630	A4536.33/228/W	4048
93.70"	34.5W	A4536.33/238/XW	3588	A4536.33/238/WW	3795	A4536.33/238/W	4232
97.64"	36W	A4536.33/248/XW	3744	A4536.33/248/WW	3960	A4536.33/248/W	4416
101.57"	37.5W	A4536.33/258/XW	3900	A4536.33/258/WW	4125	A4536.33/258/W	4600

★ Artículo standard a catalogo - Standard catalogue item

# Wanda

Design U.T. EGOLUCE

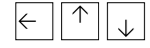

Cobra studios design - HUGUES DELAUNAY & KENNY DECOMMER

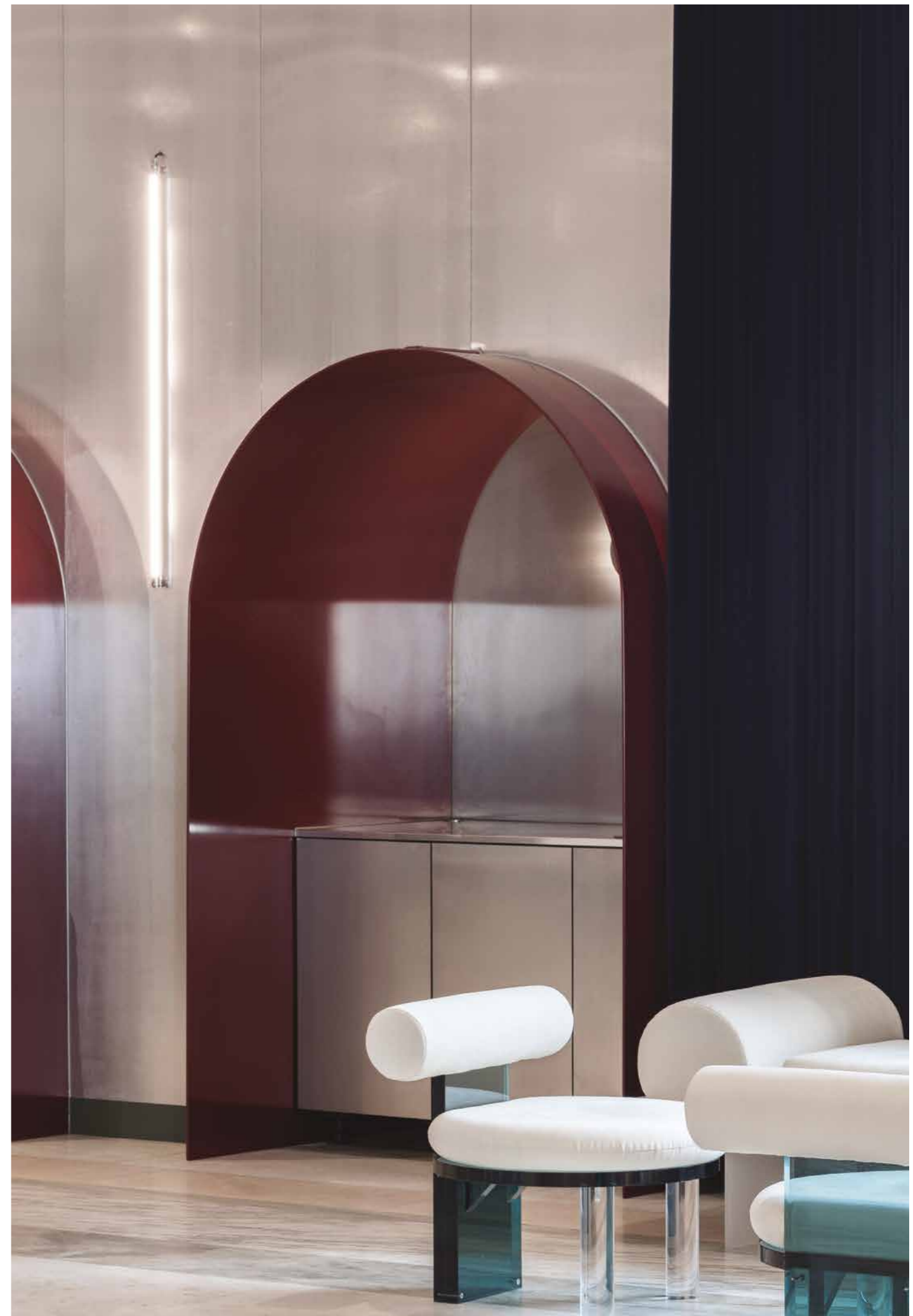
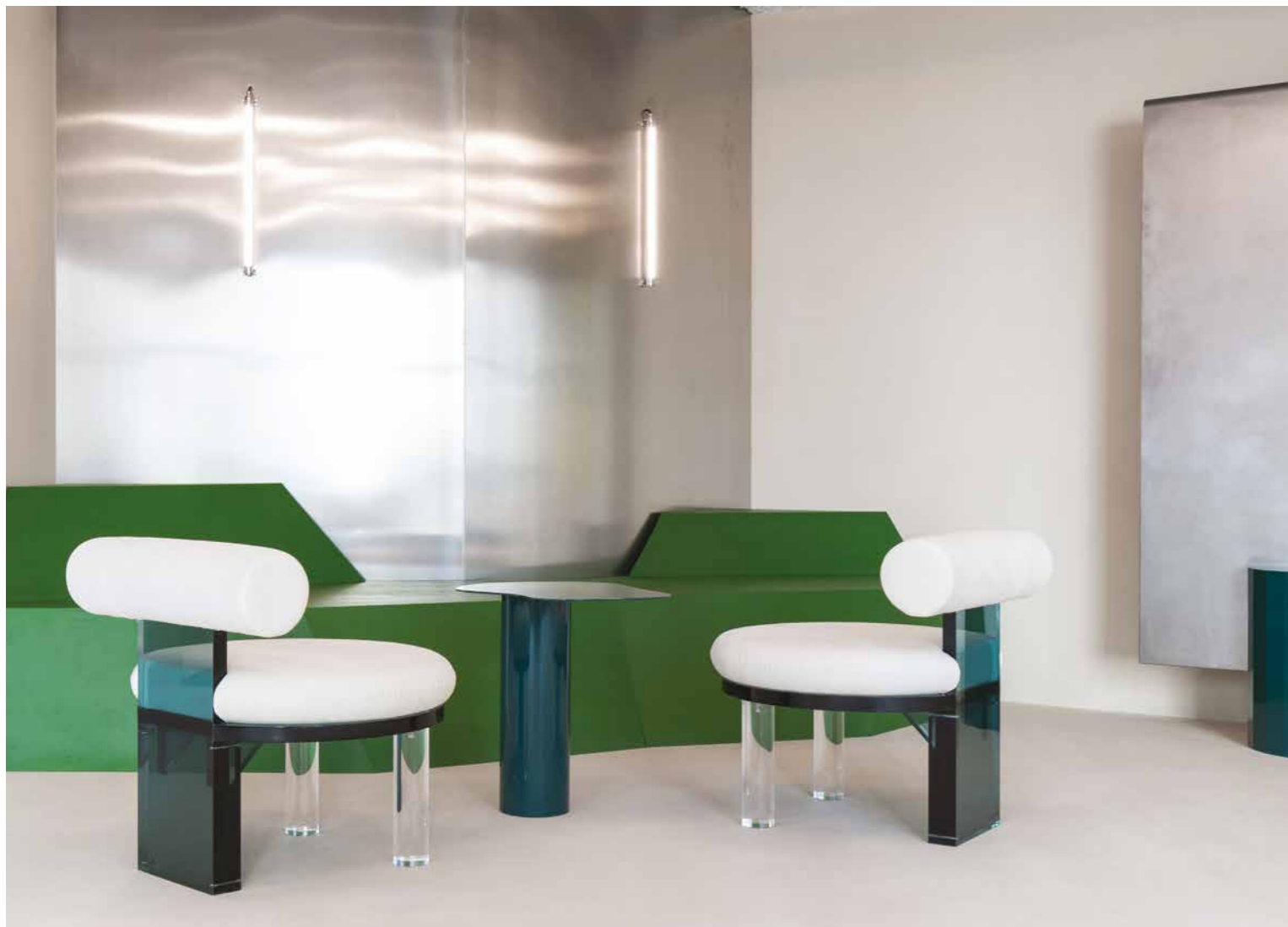

Cobra studios design - HUGUES DELAUNAY & KENNY DECOMMER

# Wanda

Design U.T. EGOLUCE

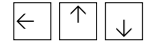



# Wanda

Design U.T. EGOLUCE

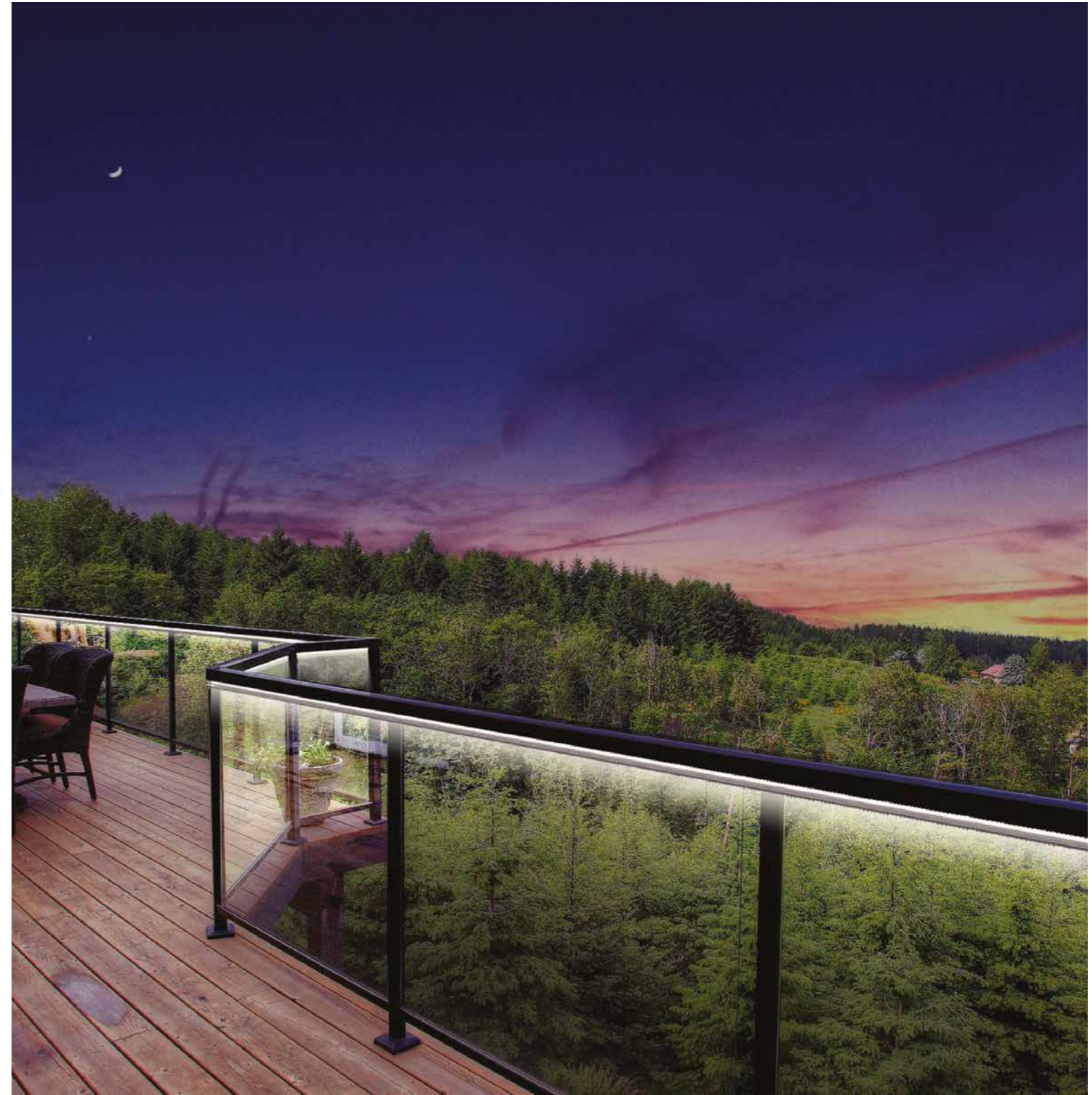
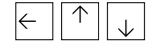

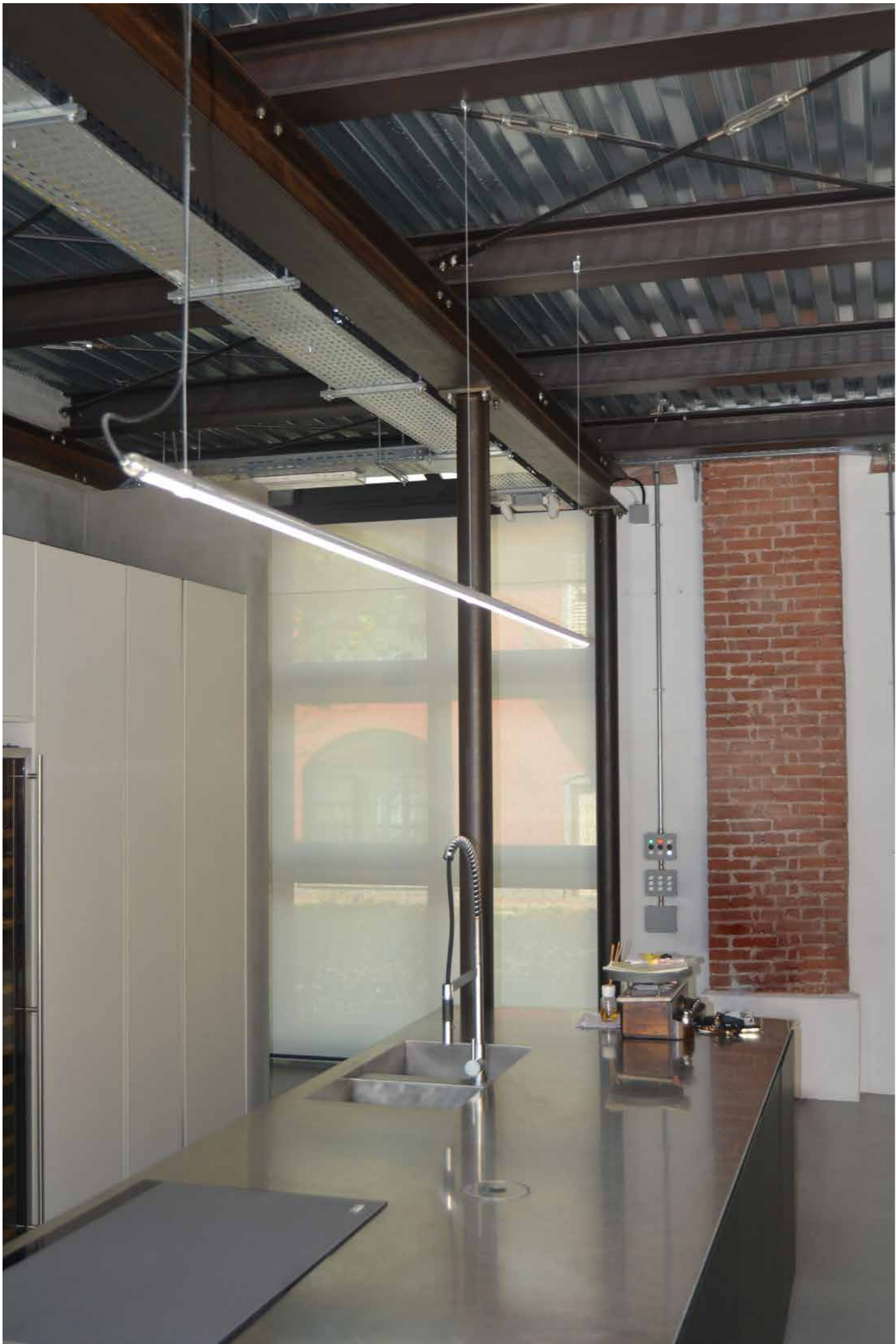

# Wanda System

Design U.T. EGOLUCE



# Wanda System

Design U.T. EGOLUCE



Accessories and rosettes for suspension systems p.215  
 Accesorios y rosetas para sistemas de suspensión p.215

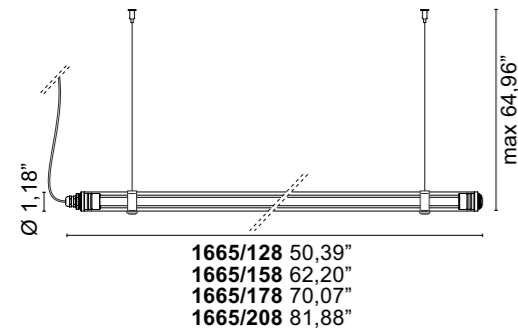

1665.\_ / 128 / \_ \_ 2.43 lb

.33 ■ Stainless steel AISI 316L - Acero cepillado

/W	4000K	LED 18W CRI>90	24V	2208lm
/WW	3000K	LED 18W CRI>90	24V	1980lm
/XW	2700K	LED 18W CRI>90	24V	1872lm



1665.\_ / 158 / \_ \_ 3.00 lb

.33 ■ Stainless steel AISI 316L - Acero cepillado

/W	4000K	LED 22,5W CRI>90	24V	2760lm
/WW	3000K	LED 22,5W CRI>90	24V	2475lm
/XW	2700K	LED 22,5W CRI>90	24V	2340lm



1665.\_ / 178 / \_ \_ 3.37 lb

.33 ■ Stainless steel AISI 316L - Acero cepillado

/W	4000K	LED 25,5W CRI>90	24V	3128lm
/WW	3000K	LED 25,5W CRI>90	24V	2805lm
/XW	2700K	LED 25,5W CRI>90	24V	2652lm



1665.\_ / 208 / \_ \_ 3.95 lb

.33 ■ Stainless steel AISI 316L - Acero cepillado

/W	4000K	LED 30W CRI>90	24V	3680lm
/WW	3000K	LED 30W CRI>90	24V	3300lm
/XW	2700K	LED 30W CRI>90	24V	3120lm



Suspension fixing kit and ceiling canopies, power supplies separately ordered

El kit de montaje en suspensión y las rosetas con fuentes de alimentación deben pedirse por separado

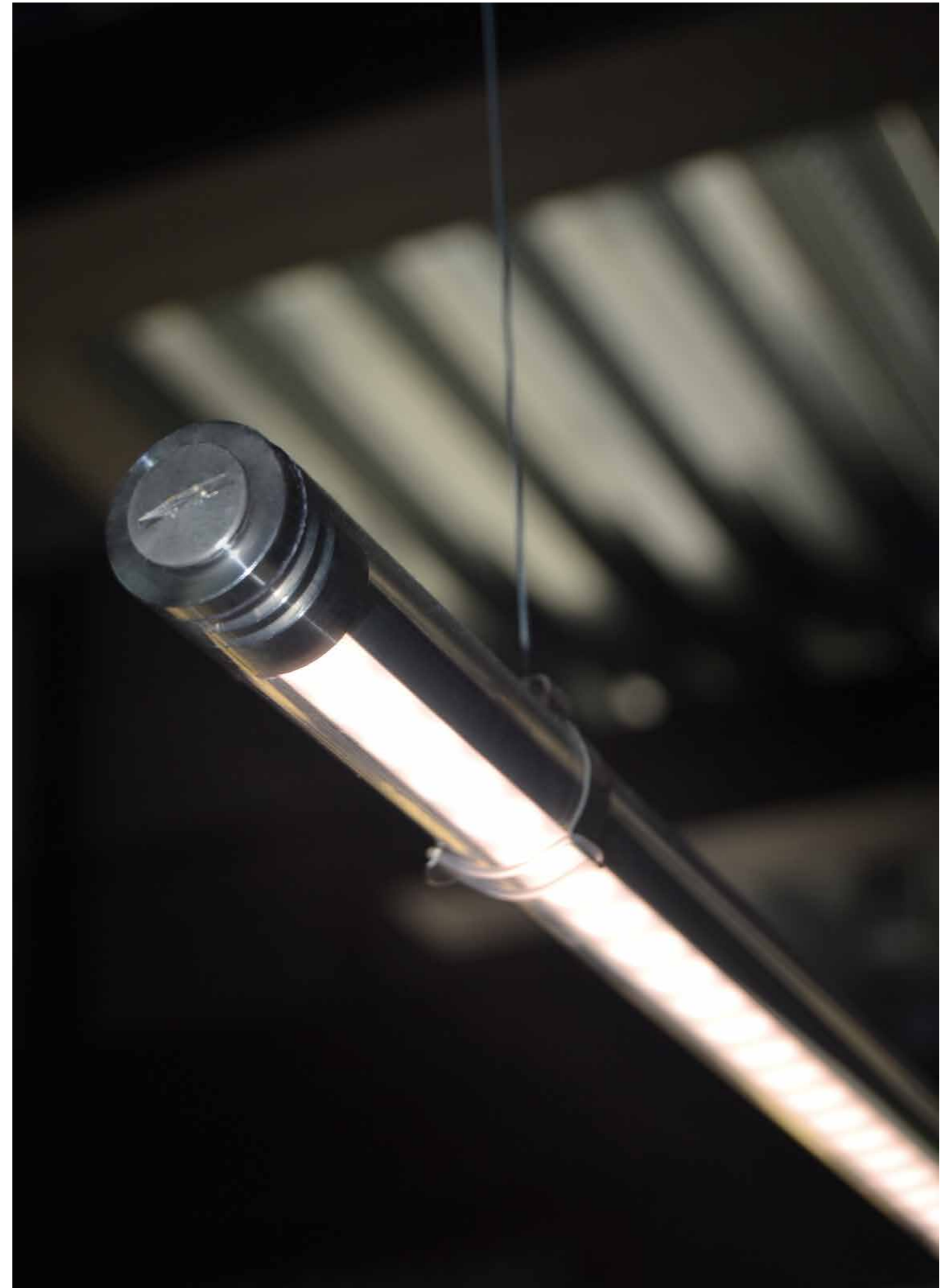
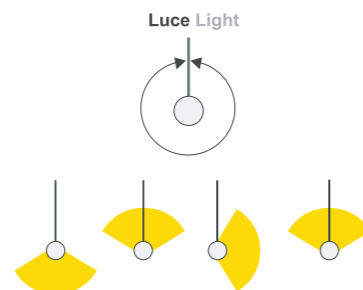
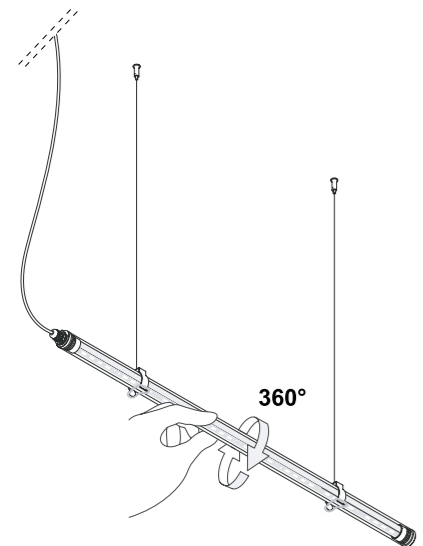

# Wanda System

Design U.T. EGOLUCE

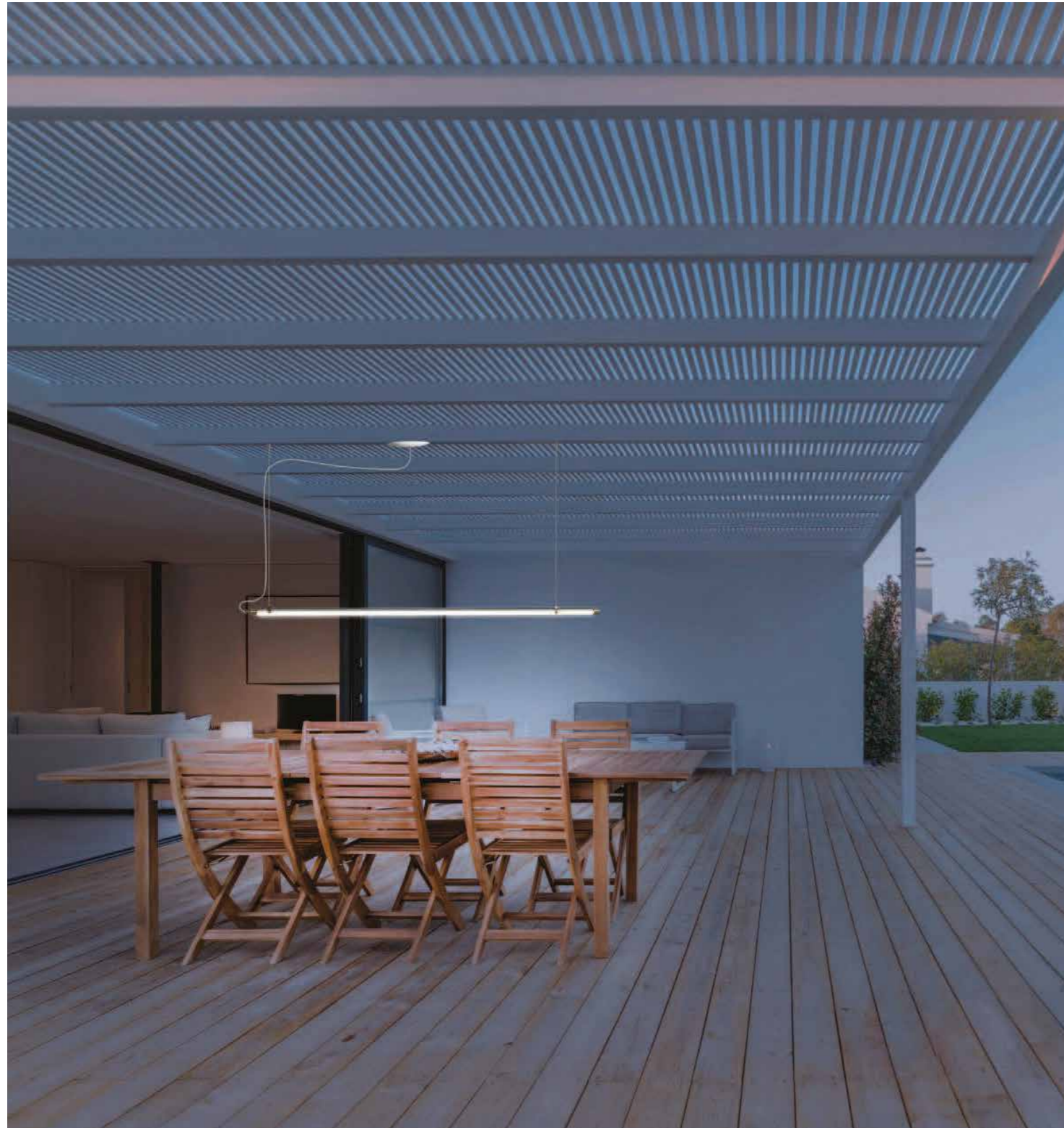

## CEILING ROSES FOR SUSPENSION SYSTEMS 24V / ROSETAS PARA SISTEMAS DE SUSPENSIÓN DE 24V

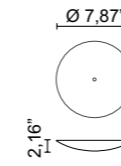

Canopy complete with 60W driver  
Rosetón completa con controlador de 60W

U0990/60 . _ _		1.32 lb
.01	White - Blanco	60 W
.02	Black - Negro	60 W
.85	Painted silver finishing - Plata pintada	60 W
.86	Painted gold finishing - Oro pintado	60 W
.87	Painted copper finishing - Cobre pintado	60 W
.88	Painted bronze finishing - Bronce pintado	60 W

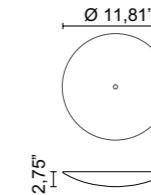

Canopy complete with 99W driver  
Rosetón completa con controlador de 99W

U0990/100 . _ _ / _ _		2.87 lb
.01	White - Blanco	99 W
.02	Black - Negro	99 W
.85	Painted silver finishing - Plata pintada	99 W
.86	Painted gold finishing - Oro pintado	99 W
.87	Painted copper finishing - Cobre pintado	99 W
.88	Painted bronze finishing - Bronce pintado	99 W

/P	DIMMER		MAX 75W
/V	DIMMER		MAX 75W
/D	DIMMER		MAX 75W

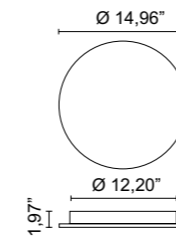

Canopy complete with driver 198W  
Roseta completa con driver de 198W

U0990/200 . _ _ / _ _		4.41 lb
.01	White - Blanco	198 W
.02	Black - Negro	198 W
.85	Painted silver finishing - Plata pintada	198 W
.86	Painted gold finishing - Oro pintado	198 W
.87	Painted copper finishing - Cobre pintado	198 W
.88	Painted bronze finishing - Bronce pintado	198 W

/P	DIMMER		MAX 2x75W
/V	DIMMER		MAX 2x75W
/D	DIMMER		MAX 2x75W



# Wanda System

Design U.T. EGOLUCE



# Wanda System

Design U.T. EGOLUCE

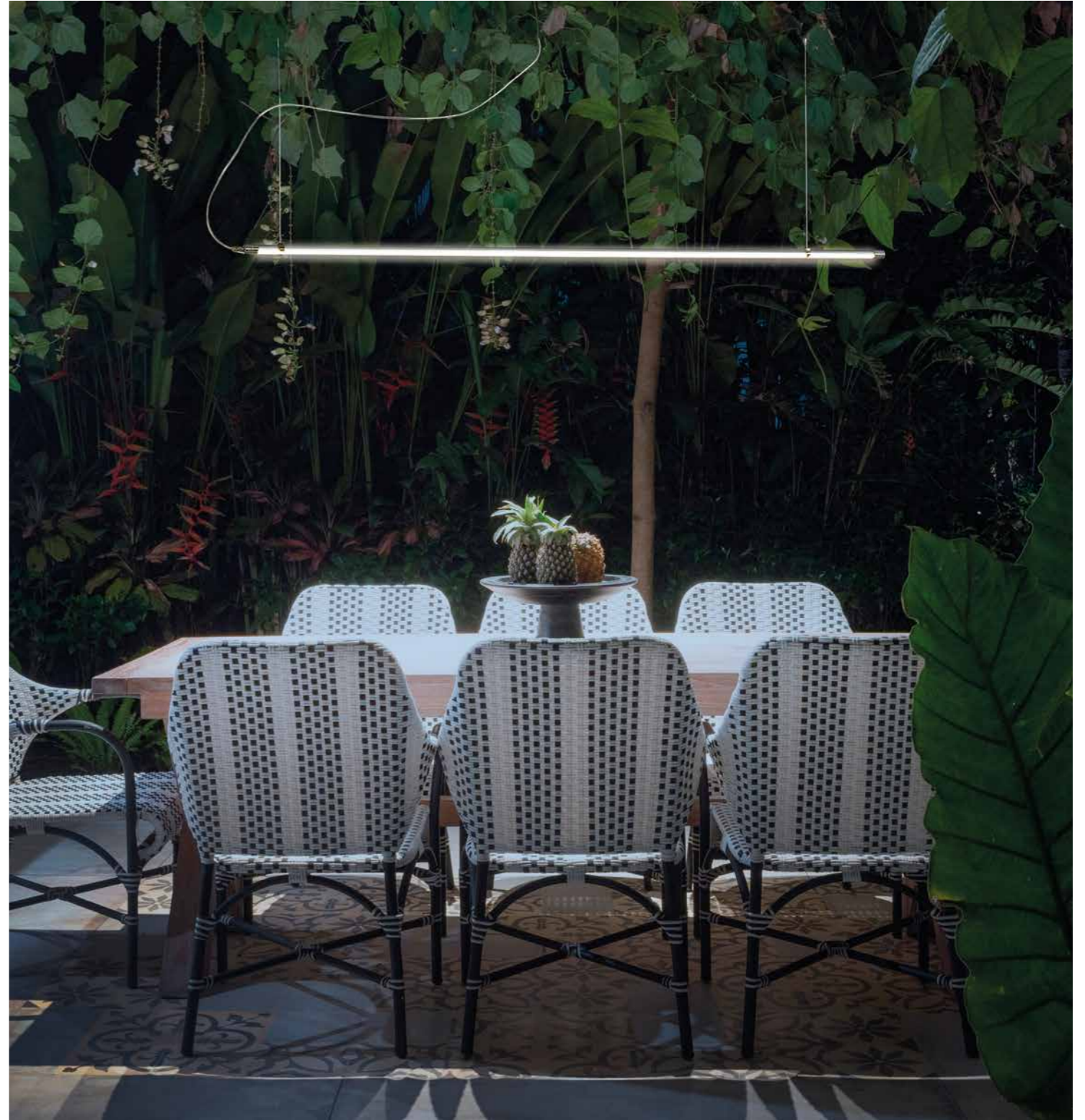

INDOOR / OUTDOOR

# Spooky

Design U.T. Egoluce

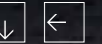

LED linear walk-over IP67 in coextruded transparent and opal methacrylate. Modular anodized aluminium blind boxes (reinforced anodizing for outdoor). To be installed into floor or wall and possibility to compose endless light lines.

*Linea luminosa LED pisable IP67 en metacrilato coextruso transparente y opal. Cajetin modular en aluminio anodizado (anodización reforzada para exterior). Instalacion a suelo o pared y posibilidad de realizar lineas luminosas continuas.*

# Spooky

Design U.T. EGOLUCE

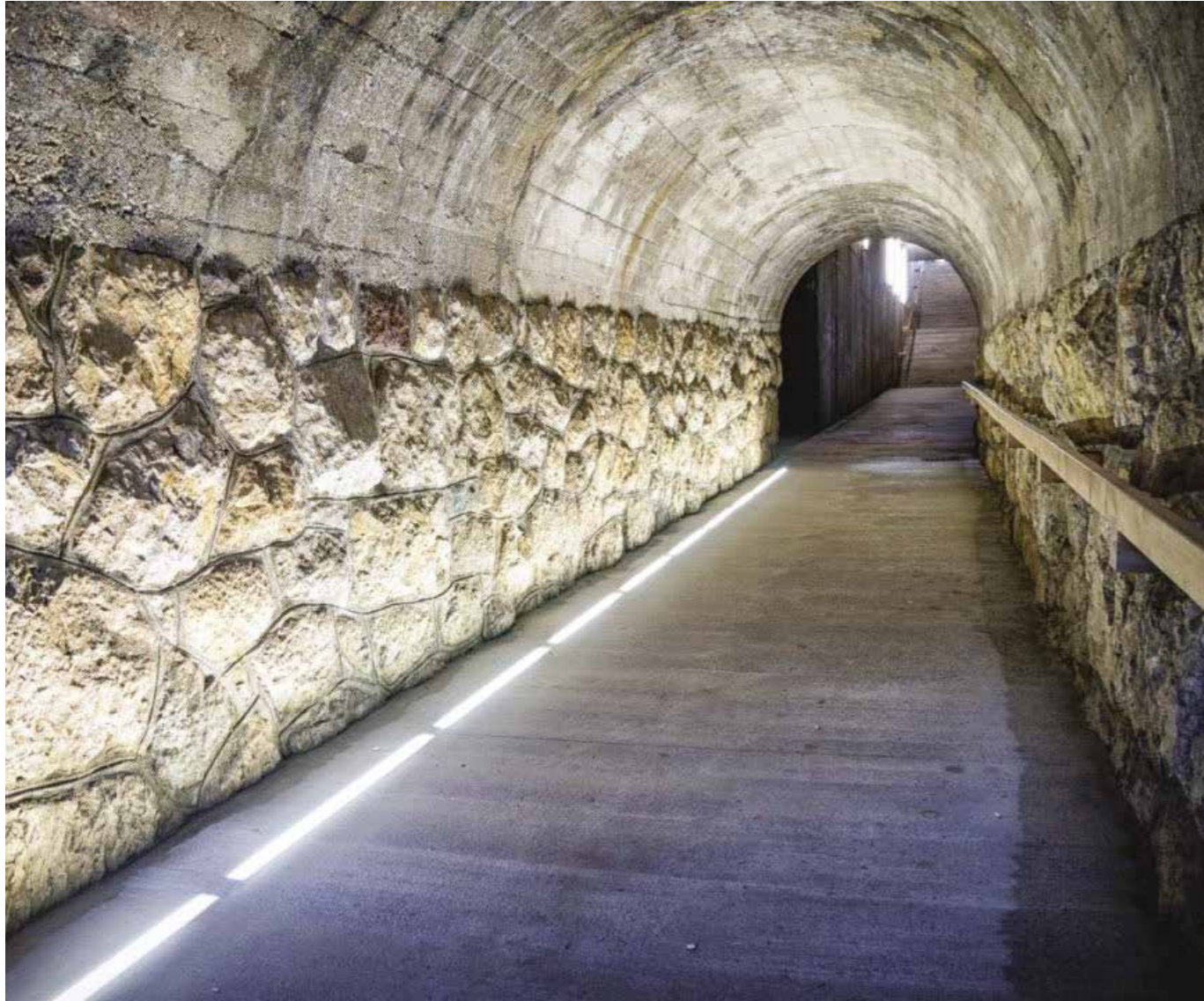



# Spooky

Design U.T. EGOLUCE



# Spooky

Design U.T. EGOLUCE





## Spooky

Design U.T. EGOLUCE

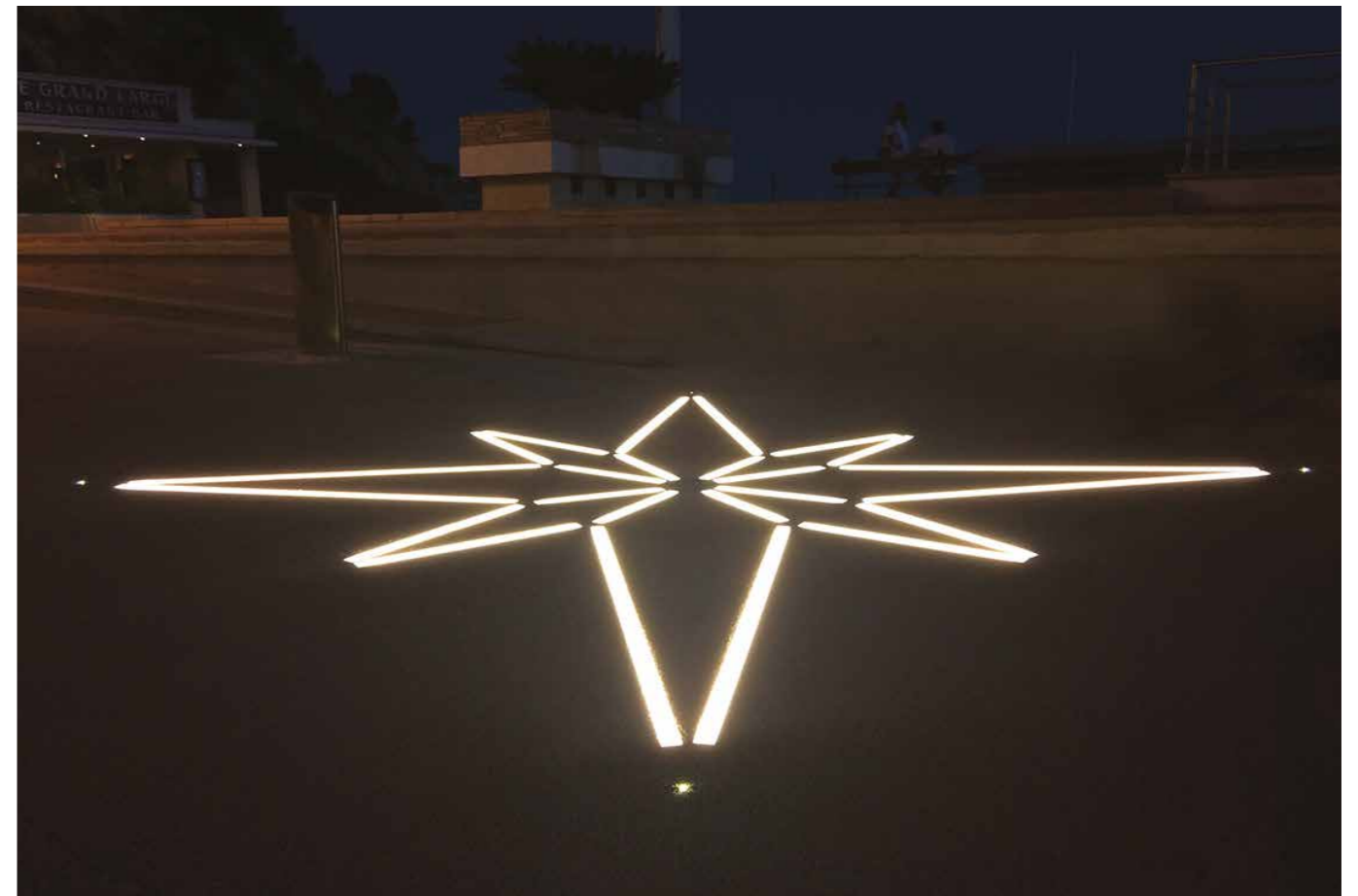

# Spooky

Design U.T. EGOLUCE

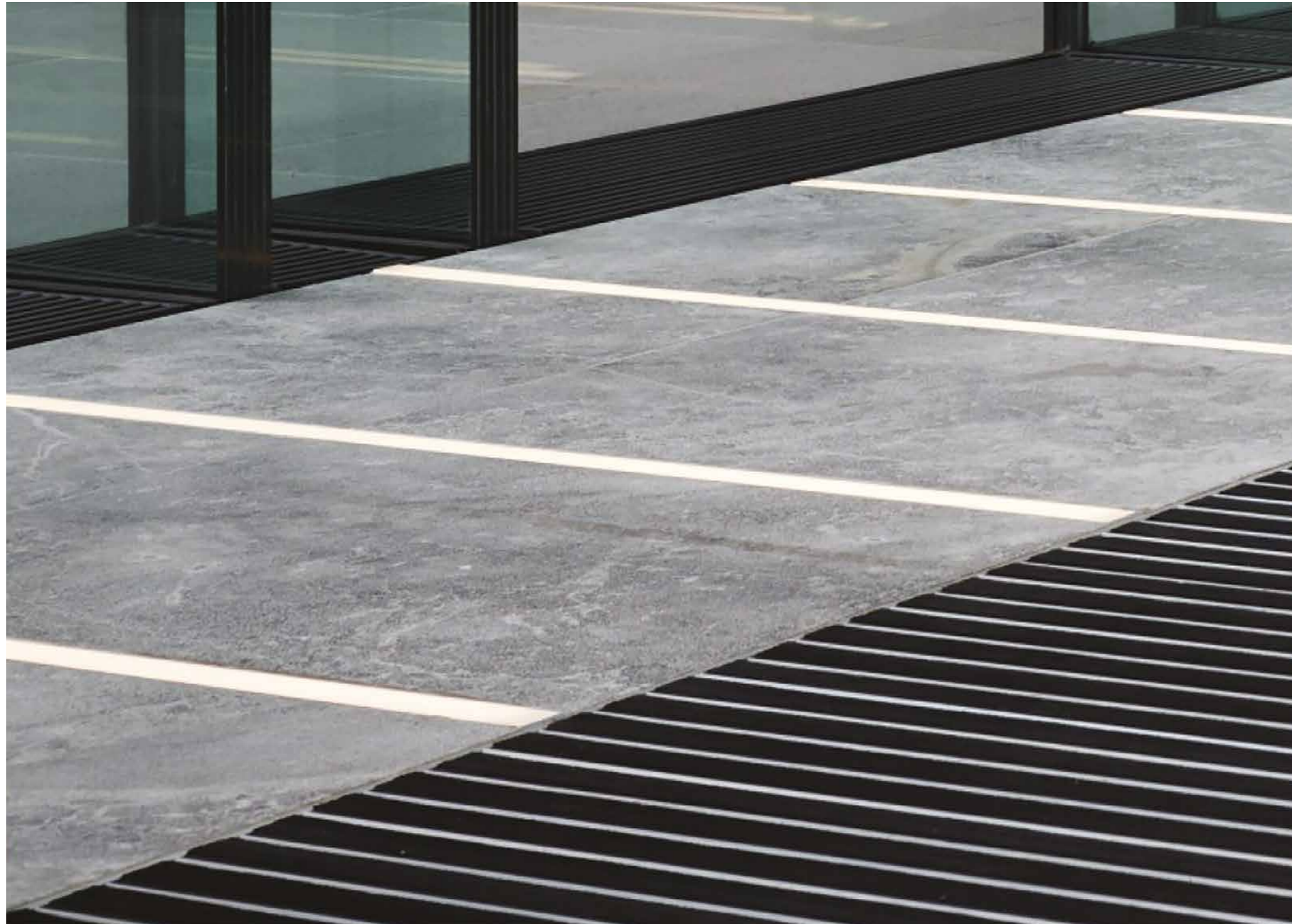

# Spooky

Design U.T. EGOLUCE

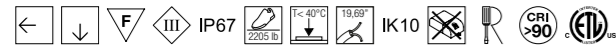

IP67 connector included  
Conector IP67 incluido

## Spooky system codes. Códigos de sistema espeluznantes

6417.01 21,25"  
6418.01 40,94"  
6419.01 60,62"  
A6417.01 5,51"... 56,69"

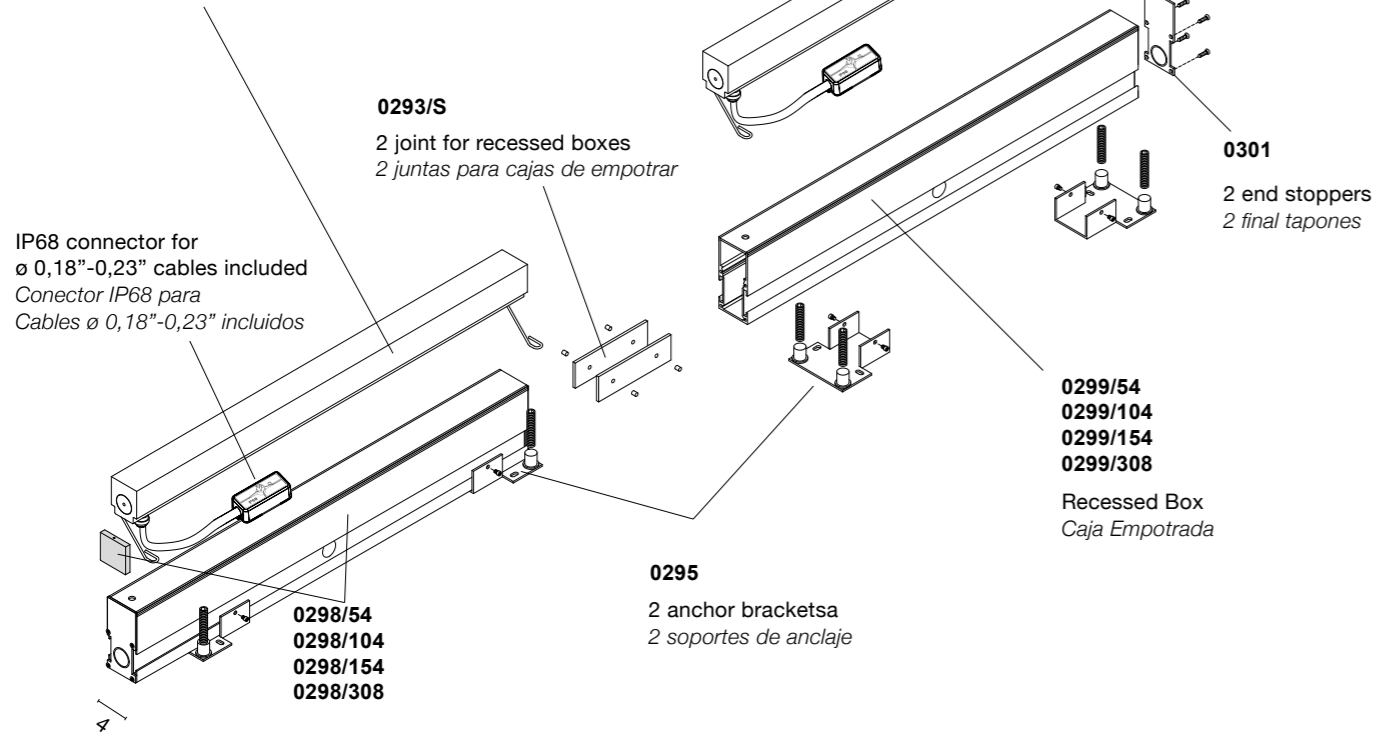

Starting recessed box with element for lamp maintenance.  
Caja de empotrar de arranque con elemento para el mantenimiento de la lámpara.

\* The end stopper is included in the starting box. El tope final está incluido en la caja de inicio.

## SYSTEM ELEMENTS ELEMENTOS DEL SISTEMA

Length (inches)	Weight (lb)	Power (W)	Light Output (lm)
21,26"	1.76 lb	4,8W	540lm
40,94"	3.53 lb	9,6W	1080lm
60,63"	5.07 lb	14,4W	1620lm

Code	Color	Power (W)	Light Output (lm)
6417.01	White - Blanco	4,8W	540lm
6418.01	White - Blanco	9,6W	1080lm
6419.01	White - Blanco	14,4W	1620lm

Code	Color	Power (W)	Light Output (lm)
6417.01	White - Blanco	4,8W	510lm
6418.01	White - Blanco	9,6W	1020lm
6419.01	White - Blanco	14,4W	1530lm

## SYSTEM ELEMENTS ELEMENTOS DEL SISTEMA



Starting recessed box with caps and element for lamp maintenance  
Encofrado de arranque con tacos y elemento para mantenimiento de lámparas

0298 / \_ \_  
/54 21,69" x 1,57" x 3,54"  
/104 41,37" x 1,57" x 3,54"  
/154 61,06" x 1,57" x 3,54"



Recessed box  
Encofrado

0299 / \_ \_  
/54 21,69" x 1,57" x 3,54"  
/104 41,37" x 1,57" x 3,54"  
/154 61,06" x 1,57" x 3,54"  
/308 121,29" x 1,57" x 3,54"



2 anchor brackets for recessed box  
2 escuadras de anclaje para encofrado

0295



2 joints for recessed boxes  
2 juntas de encofrado

0293/S



2 end stoppers for recessed box  
2 tapas de encofrado

0301

## CUSTOM SIZE

Table of available lengths on request. Measures are referred to complete fixtures including closing heads.  
Tabla de longitudes disponible previa solicitud. Las medidas se refieren a la longitud total de las lámparas.

inches	watt	3000K (WW)	lm	4000K (W)	lm
5.51"	1W	A6417.01/14/WW	102	A6417.01/14/W	108
9.45"	1,9W	A6417.01/24/WW	204	A6417.01/24/W	216
13.39"	2,9W	A6417.01/34/WW	306	A6417.01/34/W	324
17.32"	3,8W	A6417.01/44/WW	408	A6417.01/44/W	432
21.26"	4,8W	6417.01/WW *	510	6417.01/W *	540
25.20"	5,8W	A6417.01/64/WW	612	A6417.01/64/W	648
29.13"	6,7W	A6417.01/74/WW	714	A6417.01/74/W	756
33.07"	7,7W	A6417.01/84/WW	816	A6417.01/84/W	864
37.01"	8,8W	A6417.01/94/WW	918	A6417.01/94/W	972
40.94"	9,6W	6418.01/WW *	1020	6418.01/W *	1080
44.88"	10,6W	A6417.01/114/WW	1122	A6417.01/114/W	1188
48.82"	11,5W	A6417.01/124/WW	1224	A6417.01/124/W	1296
52.76"	12,5W	A6417.01/134/WW	1326	A6417.01/134/W	1404
56.69"	13,4W	A6417.01/144/WW	1428	A6417.01/144/W	1512
60.63"	14,4W	6419.01/WW *	1530	6419.01/W *	1620

## DRIVERS CONDUCTORES

U0160/24

IN:120-277V OUT:24V-60W

U0161/24

IN:120-277V OUT:24V-100W

# Spooky

Design U.T. EGOLUCE



INDOOR / OUTDOOR

# Zeppelin

Design U.T. Egołuce



Series of walkable downlights (IP 67) with AISI 316L stainless steel flange, aluminum heat sink and 11,81" neoprene cable. Available in round and square versions. Formwork or plasterboard mounting with special accessory.

*Serie de proyectores orientables (IP 67) con brida de acero inoxidable AISI 316L, disipador de calor de aluminio y cable de neopreno de 11,81". Disponible en versiones redonda y cuadrada. Montaje en encofrado o pladur con accesorio especial.*

# Zeppelin

Design U.T. EGOLUCE

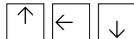



# Zeppelin

Design U.T. EGOLUCE

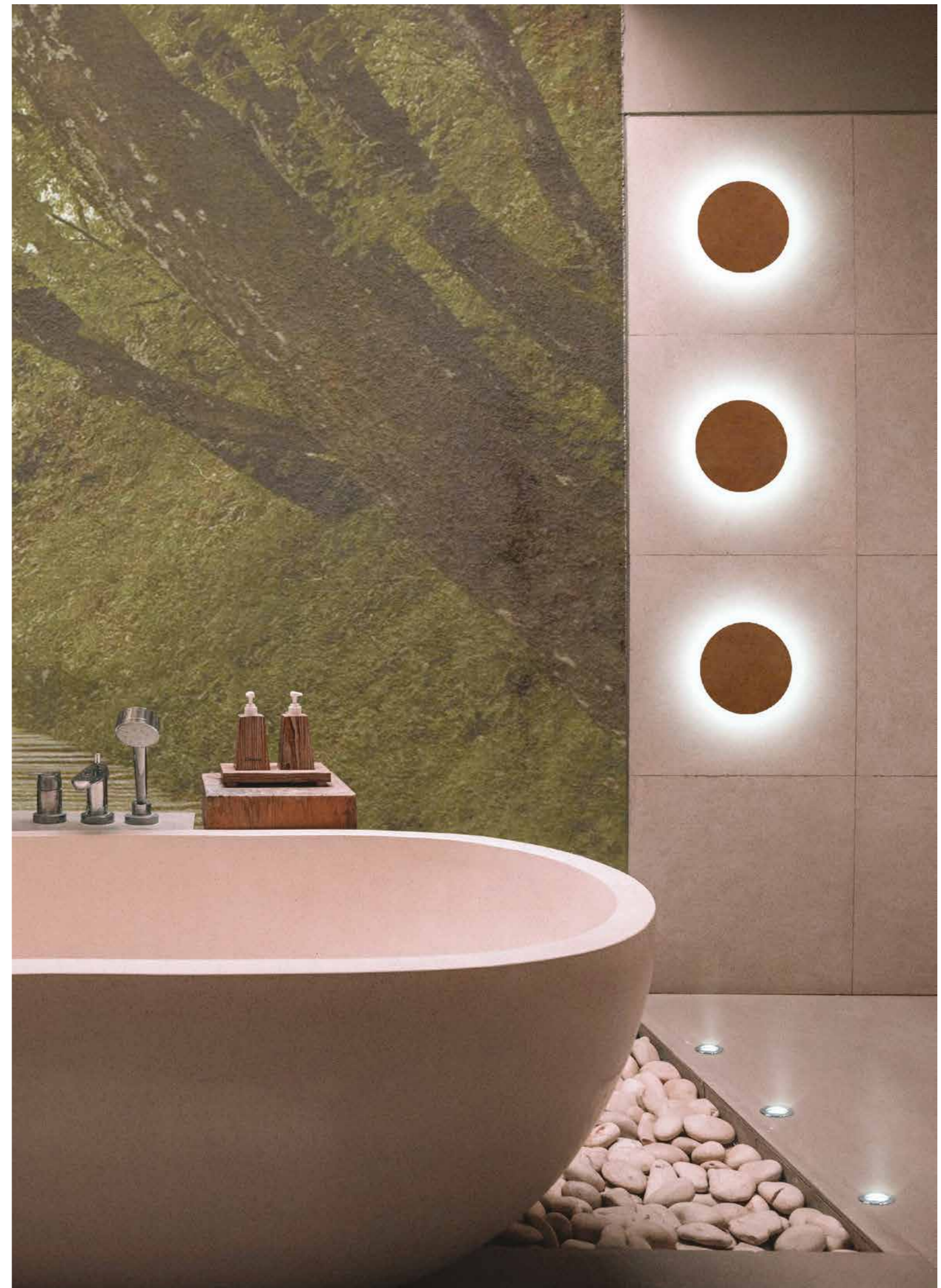
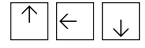



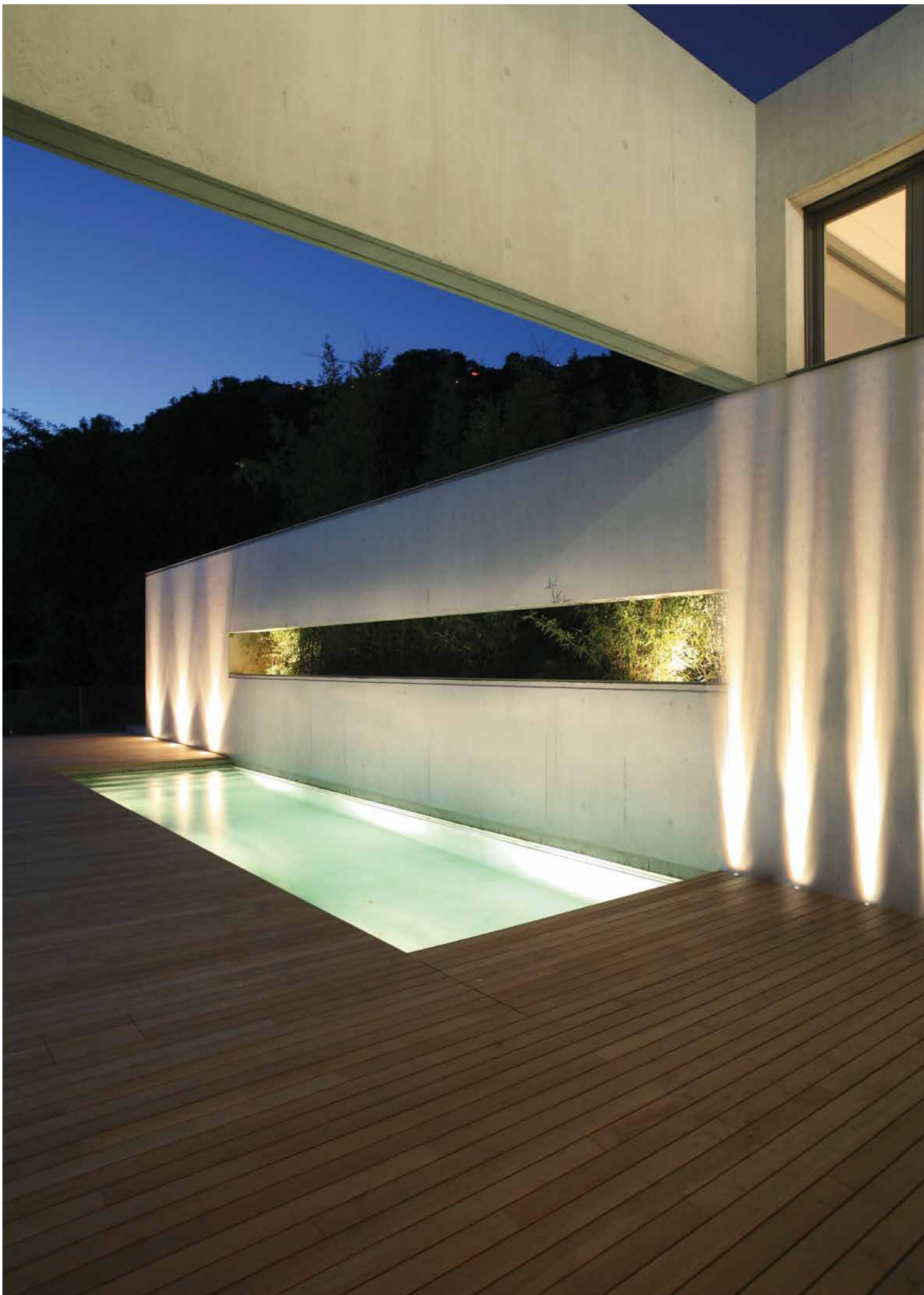

# Zeppelin 25 Plus

Design U.T. EGOLUCE



Plasterboard spring included  
Muelle de escayola incluido

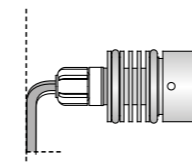

2,95"

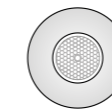

Ø 1,57"

ROUND / RONDA

**6384.** \_ / \_ \_ 0.20 lb

**.33** ■ Stainless steel AISI 316L - Acero cepillado

Optic degree

/W	/11	/25	/45	LED max 2W 500mA	209lm	4000K
/WW	/11	/25	/45	LED max 2W 500mA	199lm	3000K
/XW	/11	/25	/45	LED max 2W 500mA	189lm	2700K

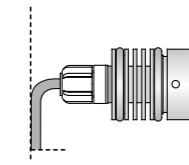

2,95"

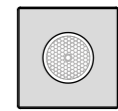

1,57"x1,57"

FRAMEWORK / MARCO

**6394.** \_ / \_ \_ 0.22 lb

**.33** ■ Stainless steel AISI 316L - Acero cepillado

Optic degree

/W	/11	/25	/45	LED max 2W 500mA	209lm	4000K
/WW	/11	/25	/45	LED max 2W 500mA	199lm	3000K
/XW	/11	/25	/45	LED max 2W 500mA	189lm	2700K



## ACCESSORIES ACCESORIOS



Plastic Box  
Caja de plástico

**0216**



Kit draining junction box + IP68  
connector  
Kit de encofrado de drenaje +  
conector IP68

**0220**

## DRIVERS CONDUCTORES

**0127** Drivers 500 mA - 1-6 Zeppelin 25 Plus

**0128** Drivers 350 mA - 1-10 Zeppelin 25 Plus

**0141/DIM** Multi-power dimmable driver PUSH - 1...10V - 1-11 Zeppelin 25 Plus

**0141/DALI** Multi-power DALI dimmable driver - 1-11 Zeppelin 25 Plus

**0145/DALI** Multi-power DALI dimmable driver - 1-21 Zeppelin 25 Plus

Only serial connection - Solo conexión serie

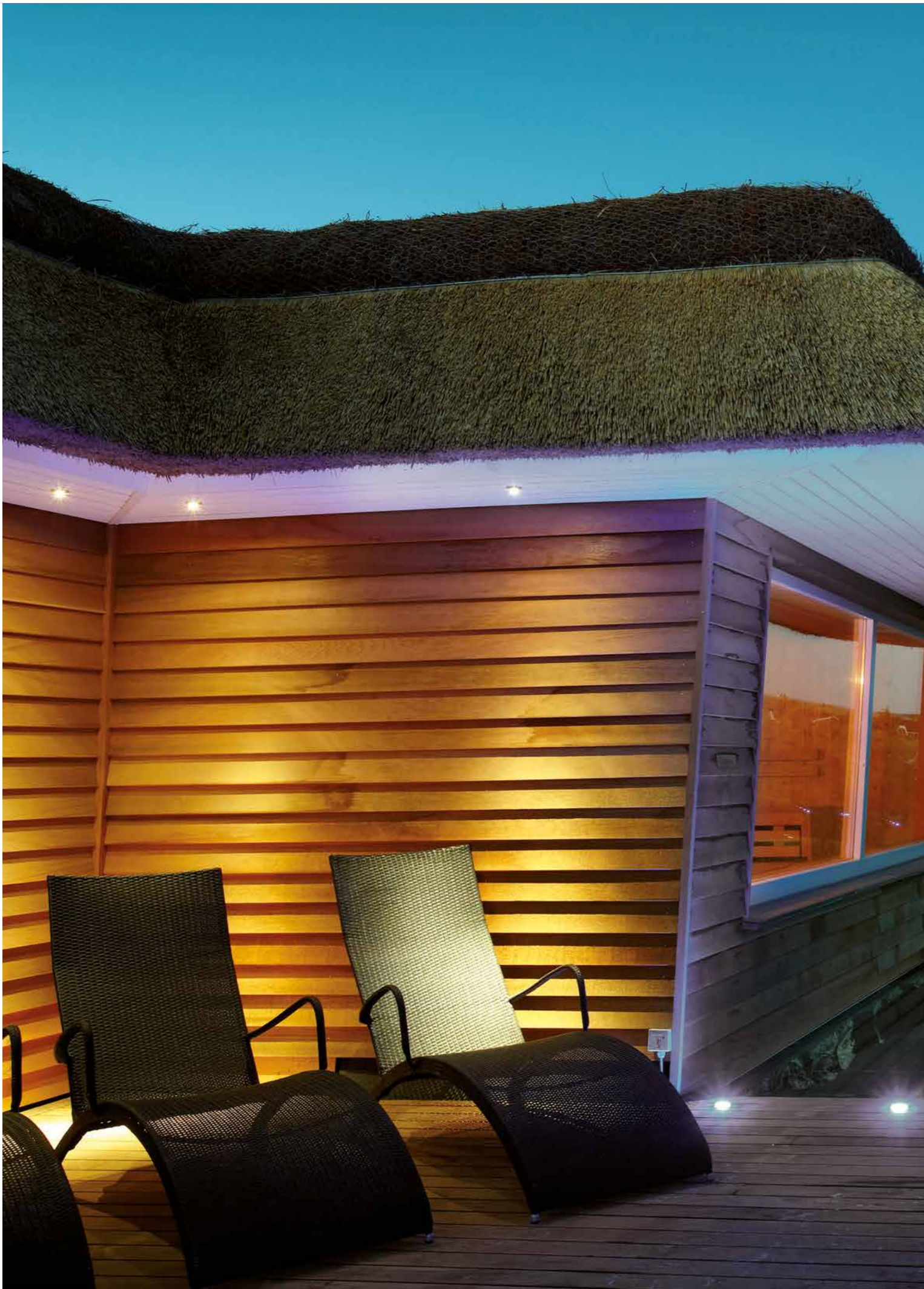

# Zeppelin Maxi

Design U.T. EGOLUCE

INOX AISI 316L  
 INOX AISI 316L

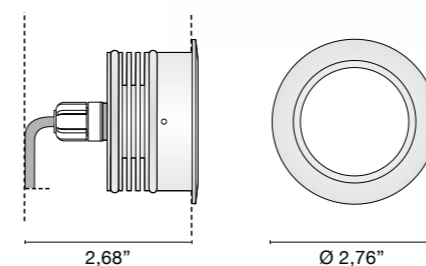

ROUND / RONDA

**6368.** / / / 0.88 lb

**.33** ■ Stainless steel AISI 316L - Acero cepillado

<b>/W</b>	LED max 3x1W 350mA	453lm	4000K
<b>/WW</b>	LED max 3x1W 350mA	429lm	3000K
<b>/XW</b>	LED max 3x1W 350mA	405lm	2700K

Wide beam / Haz de luz ancho

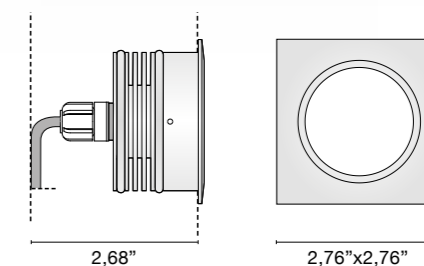

FRAMEWORK / MARCO

**6383.** / / / 0.77 lb

**.33** ■ Stainless steel AISI 316L - Acero cepillado

<b>/W</b>	LED max 3x1W 350mA	453lm	4000K
<b>/WW</b>	LED max 3x1W 350mA	429lm	3000K
<b>/XW</b>	LED max 3x1W 350mA	405lm	2700K

Wide beam / Haz de luz ancho



## ACCESSORIES ACCESORIOS



**Kit draining junction box + IP68 connector**  
*Kit de encofrado de drenaje + conector IP68*

**0230**



**Wall Plastic Box**  
*Encofrado de muros*

**0232**



**Spring for plasterboard**  
*Accesorio de montaje en cartón yeso*

2,36"

**0260**

## DRIVERS CONDUCTORES

<b>0128</b>	Drivers 350 mA - 1-3 Zeppelin Maxi
<b>0141/DIM</b>	Multi-power dimmable driver PUSH - 1...10V - 1-4 Zeppelin Maxi
<b>0141/DALI</b>	Multi-power DALI dimmable driver - 1-4 Zeppelin Maxi

<b>0145</b>	Multi-power dimmable driver PUSH - 1...10V - 1-7 Zeppelin Maxi
<b>0145/DALI</b>	Multi-power DALI dimmable driver - 1-7 Zeppelin Maxi

Only serial connection - Solo conexión serie

# Zeppelin Maxi

Design U.T. EGOLUCE

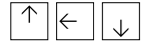

# Zeppelin COB

Design U.T. EGOLUCE



INOX AISI 316L  
INOX AISI 316L

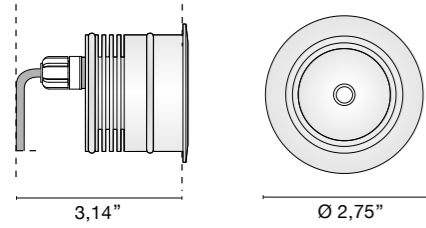

6397. \_ \_ / \_ \_ / \_ \_ 0.88 lb

.33 ■ Stainless steel AISI 316L - Acero cepillado

Optic degree				
/W	/28 /60	LED 8,9W 500mA	1353lm	4000K
/WW	/28 /60	LED 8,9W 500mA	1303lm	3000K
/XW	/28 /60	LED 8,9W 500mA	1263lm	2700K



## ACCESSORIES ACCESORIOS



2,36"

Spring for plasterboard  
Accesorio de montaje en cartón yeso

0260/C



## DRIVERS CONDUCTORES

<b>0141/DIM</b>	Multi-power dimmable driver PUSH - 1...10V - 1-2 Zeppelin Maxi COB
<b>0141/DALI</b>	Multi-power DALI dimmable driver - 1-2 Zeppelin Maxi COB
<b>0145</b>	Multi-power dimmable driver PUSH - 1...10V - 1-3 Zeppelin Maxi COB

<b>0145/DALI</b>	Multi-power DALI dimmable driver - 1-3 Zeppelin Maxi COB
<b>0127</b>	500 mA - 1 COB led
<b>0128</b>	350 mA - 1-2 COB LED

Only serial connection - Solo conexión serie



# Zeppelin turnable

Design U.T. EGOLUCE

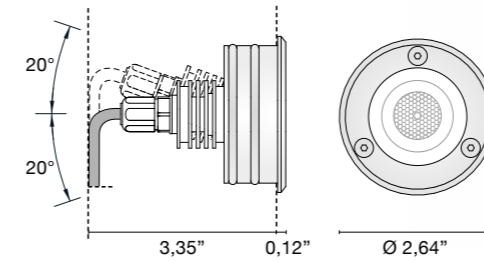

**6411** \_ / \_ / \_ 0.49 lb

**.33** ■ Stainless steel AISI 316L - *Acero cepillado*

	Optic degree				
<b>/W</b>	<b>/11</b>	<b>/25</b> <b>/45</b>	LED max 2W 500mA	209lm	4000K
<b>/WW</b>	<b>/11</b>	<b>/25</b> <b>/45</b>	LED max 2W 500mA	199lm	3000K
<b>/XW</b>	<b>/11</b>	<b>/25</b> <b>/45</b>	LED max 2W 500mA	189lm	2700K



## DRIVERS CONDUCTORES

<b>0127</b>	Drivers 500 mA - 1-6 Zeppelin turnable
<b>0141/DIM</b>	Multi-power dimmable driver PUSH - 1...10V - 1-11 Zeppelin turnable
<b>0141/DALI</b>	Multi-power DALI dimmable driver - 1-11 Zeppelin turnable
<b>0145</b>	Multi-power dimmable driver PUSH - 1...10V - 1-21 Zeppelin turnable
<b>0145/DALI</b>	Multi-power DALI dimmable driver - 1-21 Zeppelin turnable

## ACCESSORIES ACCESORIOS



**Kit draining junction box + IP68 connector**  
*Kit de encofrado de drenaje + conector IP68*

**0230**



**Wall Plastic Box**  
*Encofrado de muros*

**0232**



**Spring for plasterboard**  
*Accesorio de montaje en cartón yeso*

**0238**

2,36"

Only serial connection - *Solo conexión serie*

OUTDOOR

# Tris

Design U.T. EgoLucé



Walkable recessed outdoor spot (IP 67) with frame in stainless steel AISI 316L and heat sink in aluminum. Neoprene cable 11,81" Transparent safety glass. Mounting with the recessed box or in plasterboards employing a specific accessory (art. 0233).

*Proyector empotrable orientable para exteriores (IP 67) con marco de acero inoxidable AISI 316L y disipador de calor de aluminio. Cable de neopreno de 11,81". Cristal de seguridad transparente. Montaje con caja de empotrar o pladur con accesorio especial (art. 0233).*







OUTDOOR  
**Drive**

Design U.T. Egoluce



Drive over the recessed spot (IP 67) with frame in stainless steel AISI 316L and aluminum heat sink. Neoprene cable 11,81" diffuser in matt glass mountable with recessed box.

*Unidad empotrada (IP 67) con marco de acero inoxidable AISI 316L y disipador de calor de aluminio. Cable de neopreno 11,81" difusor de cristal opaco montable con caja de empotrar.*



# Drive

Design U.T. EGOLUCE



 IP67
 











 2,36"
 
 INOX AISI 316L  
 INOX AISI 316L

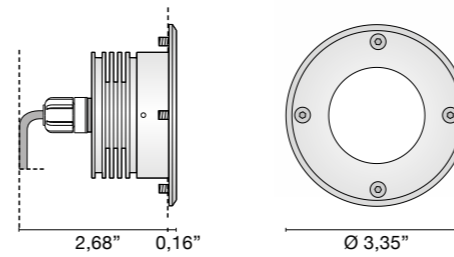

6366. \_ \_ / \_ \_ 0.88 lb

.33 ■ Stainless steel AISI 316L - Acero cepillado

/W	4000K	LED max 3x1W CRI>90	453lm
/WW	3000K	LED max 3x1W CRI>90	429lm



## ACCESSORIES ACCESORIOS



Kit draining junction box + IP68 connector  
 Kit de encofrado de drenaje + conector IP68

0229

## DRIVERS CONDUCTORES

0128	Drivers 350 mA - 1-3 Drive
0141/DIM	Multi-power dimmable driver PUSH - 1...10V - 1-4 Drive
0141/DALI	Multi-power DALI dimmable driver - 1-4 Drive

0145	Multi-power dimmable driver PUSH - 1...10V - 1-7 Drive
0145/DALI	Multi-power DALI dimmable driver - 1-7 Drive

Only serial connection - Solo conexión serie



OUTDOOR  
**Vista**

Design U.T. EgoLucé



Walkable recessed spot (IP 67) with frame in stainless steel AISI 316L and aluminum heat sink. Neoprene cable 11,81", diffuser with antidazzling eyelid mountable with or without recessed box.

*Proyector empotrable (IP 67) con marco de acero inoxidable AISI 316L y disipador de calor de aluminio. disipador térmico de aluminio. Cable de neopreno de 11,81", difusor con tapa antideslumbrante montable con o sin caja de empotrar.*



# Vista

Design U.T. EGOLUCE

IP67 1102 B 40°C

INOX AISI 316L  
INOX AISI 316L

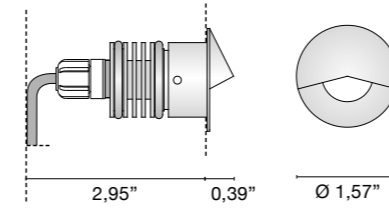

6362... / ... 0,22 lb

.33 ■ Stainless steel AISI 316L - Acero cepillado

/W 4000K LED max 2W CRI>90 209lm

/WW 3000K LED max 2W CRI>90 199lm

/XW 2700K LED max 2W CRI>90 189lm



## ACCESSORIES ACCESORIOS



Plastic Box  
Caja de plástico

0216



Kit draining junction box + IP68 connector  
Kit de encofrado de drenaje + conector IP68

0220

## DRIVERS CONDUCTORES

0127 Drivers 500 mA - 1-6 Vista

0128 Drivers 350 mA - 1-10 Vista

0141/DIM Multi-power dimmable driver PUSH - 1...10V - 1-11 Vista

0141/DALI Multi-power DALI dimmable driver - 1-11 Vista

0145 Multi-power dimmable driver PUSH - 1...10V - 1-21 Vista

0145/DALI Multi-power DALI dimmable driver - 1-21 Vista

Only serial connection - Solo conexión serie

# Vista

Design U.T. EGOLUCE

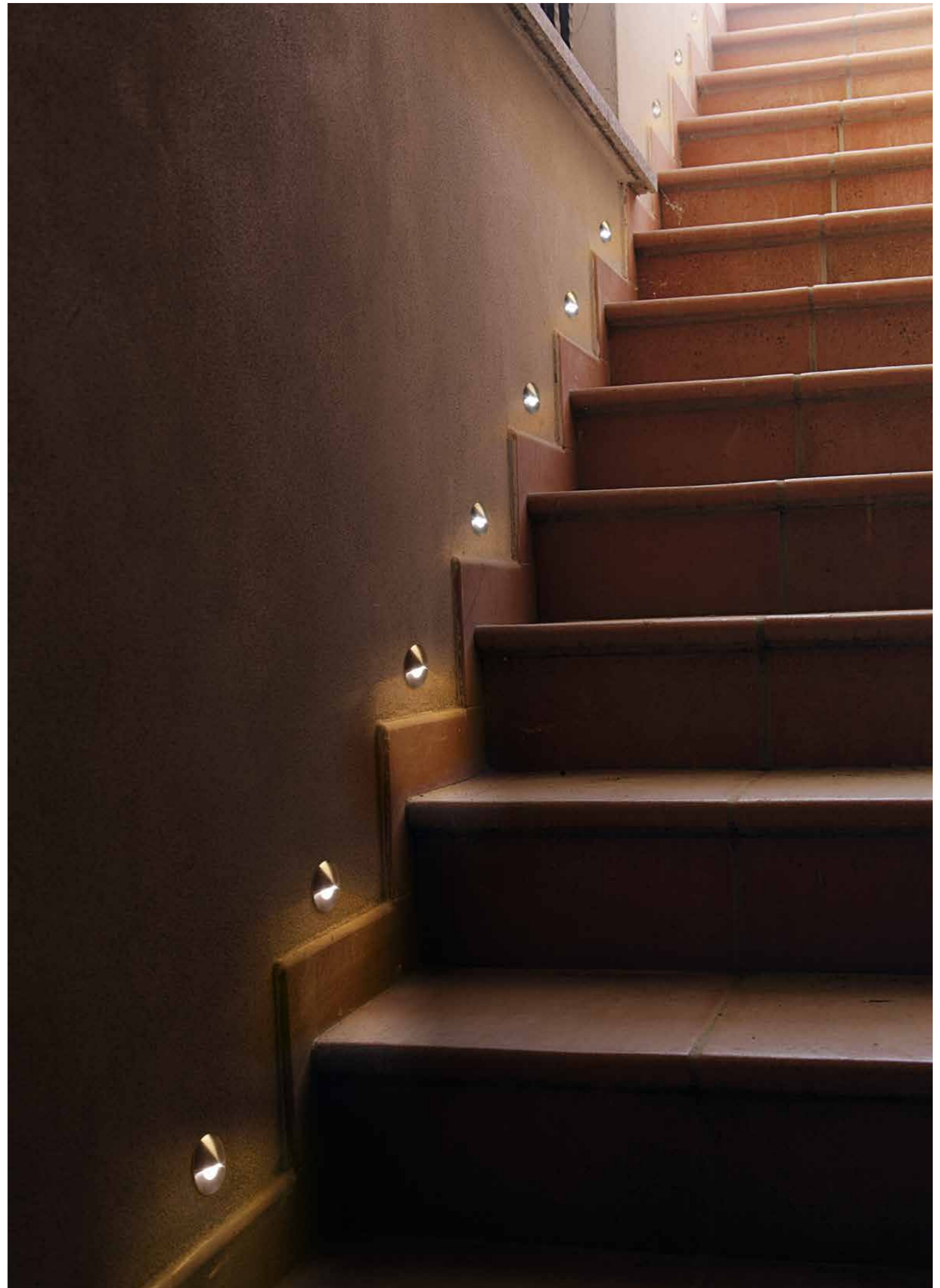
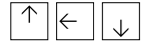

OUTDOOR  
**Kross**

Design U.T. EgoLucé



Walkable recessed spot (IP 67) with frame in stainless steel AISI 316L and aluminum heat sink. Neoprene cable 11,81" montable with or without a recessed box.

*Proyector empotrable transitable (IP 67) con marco de acero inoxidable AISI 316L y disipador de calor de aluminio. Cable de neopreno de 11,81" montable con o sin caja empotrada.*

# Kross

Design U.T. EGOLUCE

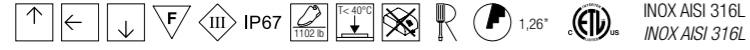

INOX AISI 316L  
INOX AISI 316L

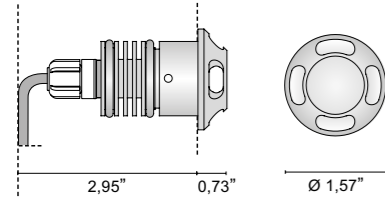

6361. \_ \_ / \_ \_ 0.22 lb

.33 ■ Stainless steel AISI 316L - *Acero cepillado*

/W 4000K LED max 2W CRI>90 209lm

/WW 3000K LED max 2W CRI>90 199lm

/XW 2700K LED max 2W CRI>90 189lm



## ACCESSORIES ACCESORIOS



Plastic Box  
*Caja de plastico*

0216

Kit draining junction box + IP68  
connector  
*Kit de encofrado de drenaje +  
conector IP68*

0220

## DRIVERS CONDUCTORES

0127 Drivers 500 mA - 1-6 Kross

0128 Drivers 350 mA - 1-10 Kross

0141/DIM Multi-power dimmable driver PUSH - 1...10V - 1-11 Kross

0141/DALI Multi-power DALI dimmable driver - 1-11 Kross

0145 Multi-power dimmable driver PUSH - 1...10V - 1-21 Kross

0145/DALI Multi-power DALI dimmable driver - 1-21 Kross

Only serial connection - *Solo conexión serie*

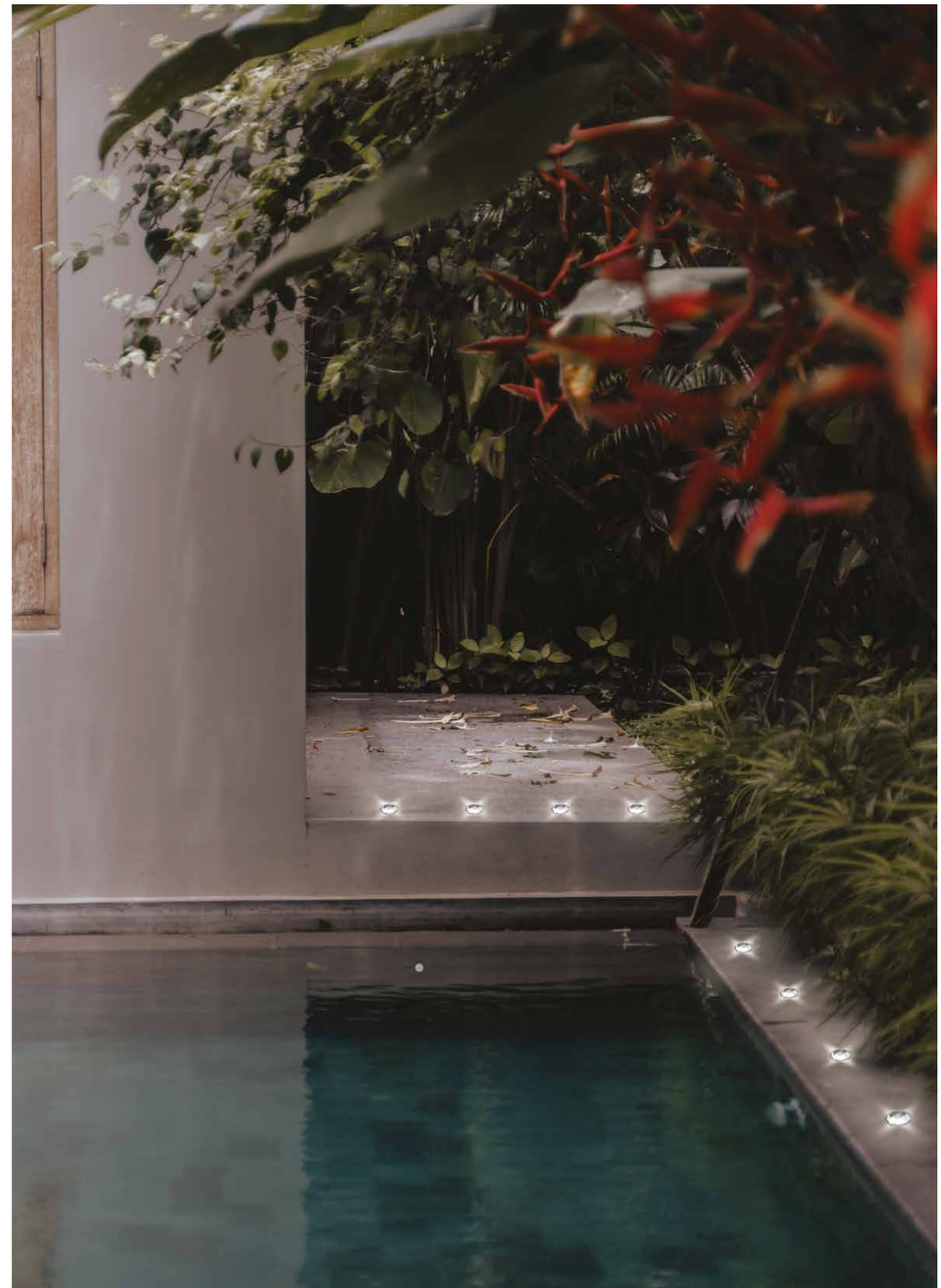



OUTDOOR  
**Step**

Design U.T. EgoIuce



Outdoor recessed spot (IP 55) for asymmetric light in anodized aluminium (reinforced anodizing for outdoor) or white lacquered finish. Neoprene cable 11,81" Available in round and square version. Mounting with recessed box.

*Foco empotrable para exterior (IP 55) con luz asimétrica en aluminio anodizado (anodizado reforzado para exterior) o lacado en blanco. Cable de neopreno de 11,81". Disponible en versiones redonda y cuadrada. Montaje con caja empotrada.*

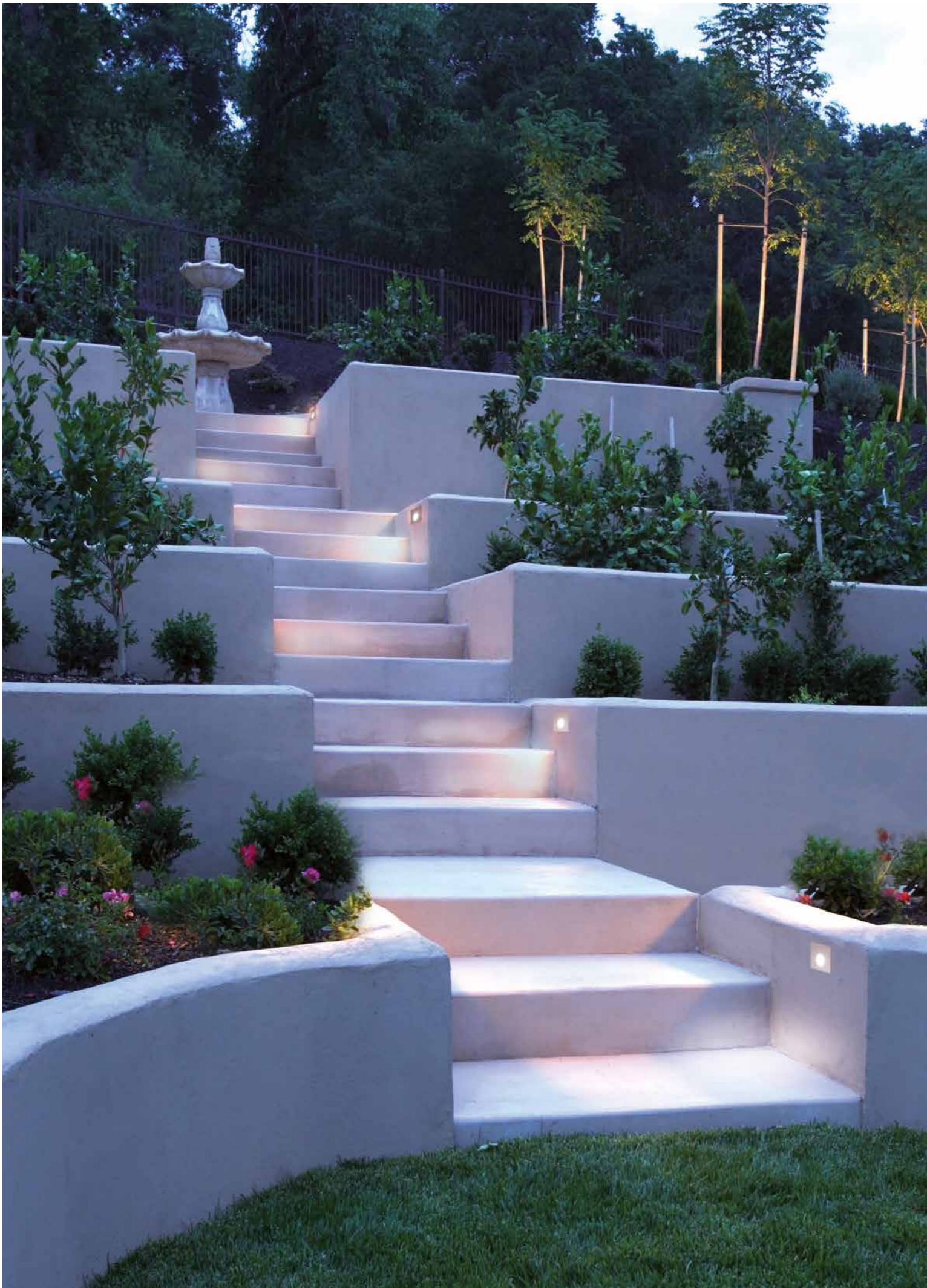

# Step

Design U.T. EGOLUCE

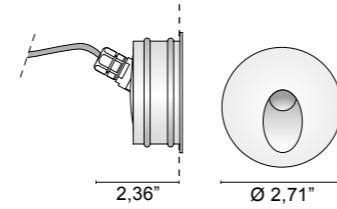

**6387**... / ... 0.53 lb

- .01**  White - Blanco
- .45**  Aluminium anodized - Aluminio anodizado

<b>/W</b>	4000K	LED max 2W CRI>90	209lm
<b>/WW</b>	3000K	LED max 2W CRI>90	199lm
<b>/XW</b>	2700K	LED max 2W CRI>90	189lm

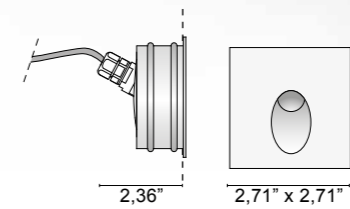

**6369**... / ... 0.66 lb

- .01**  White - Blanco
- .45**  Aluminium anodized - Aluminio anodizado

<b>/W</b>	4000K	LED max 2W CRI>90	209lm
<b>/WW</b>	3000K	LED max 2W CRI>90	199lm
<b>/XW</b>	2700K	LED max 2W CRI>90	189lm



## ACCESSORIES ACCESORIOS



Wall Plastic Box  
Encofrado de muros

**0232**

## DRIVERS CONDUCTORES

<b>0127</b>	Drivers 500 mA - 1-6 Step
<b>0128</b>	Drivers 350 mA - 1-10 Step
<b>0141/DIM</b>	Multi-power dimmable driver PUSH - 1...10V - 1-11 Step

<b>0141/DALI</b>	Multi-power DALI dimmable driver - 1-11 Step
<b>0145</b>	Multi-power dimmable driver PUSH - 1...10V - 1-21 Step
<b>0145/DALI</b>	Multi-power DALI dimmable driver - 1-21 Step

Only serial connection - Solo conexión serie

# OUTDOOR Soft

Design U.T. EgoLucé

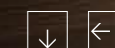

Recessed spot (IP 67) with frame in stainless steel AISI 316L. Frosted safety glass  
Neoprene cable 11,81". PARALLEL CONNECTION.

*Foco empotrable (IP 67) con marco de acero inoxidable AISI 316L. Cristal de seguridad  
esmerilado Cable de neopreno de 11,81". CONEXIÓN EN PARALELO.*

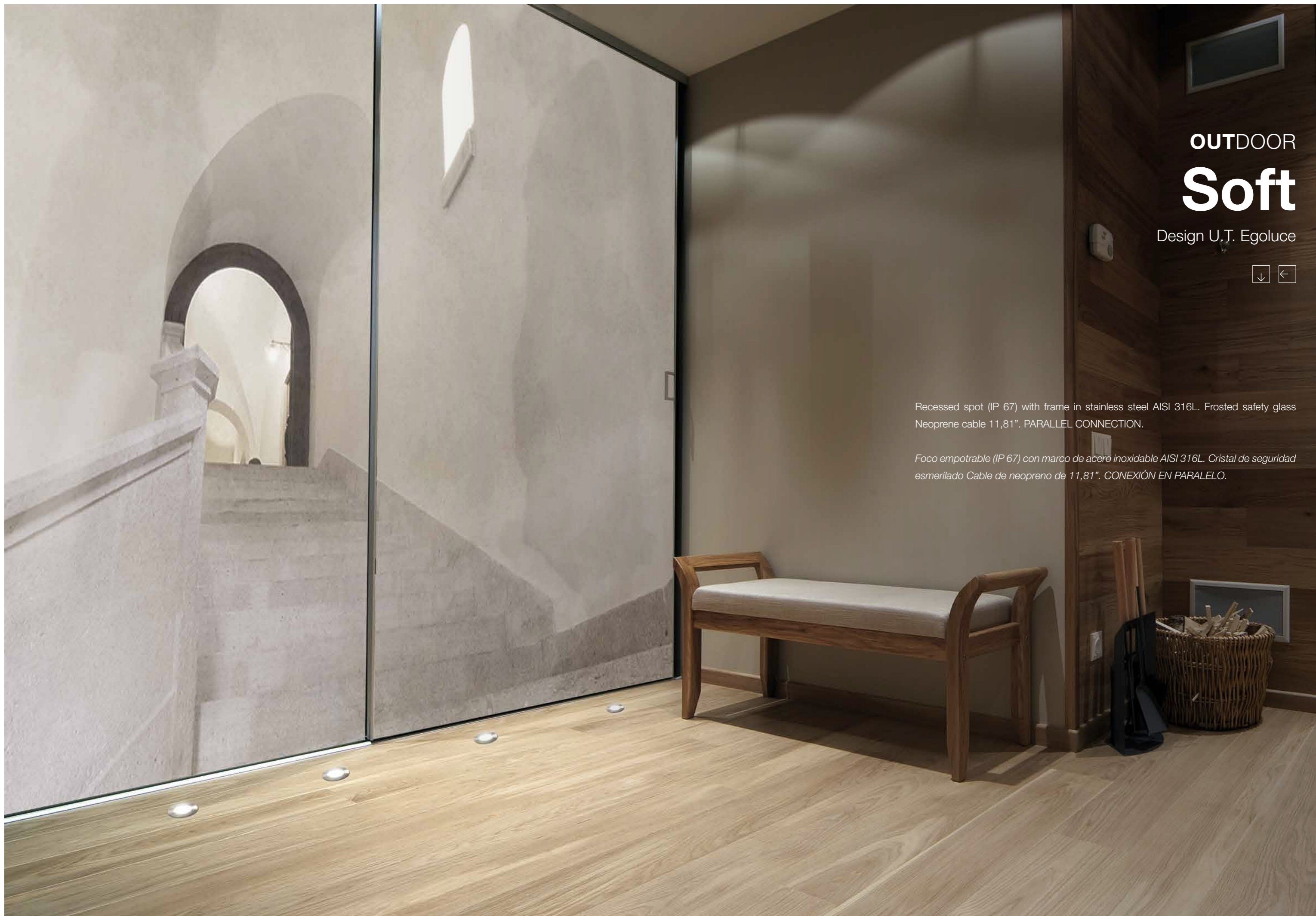

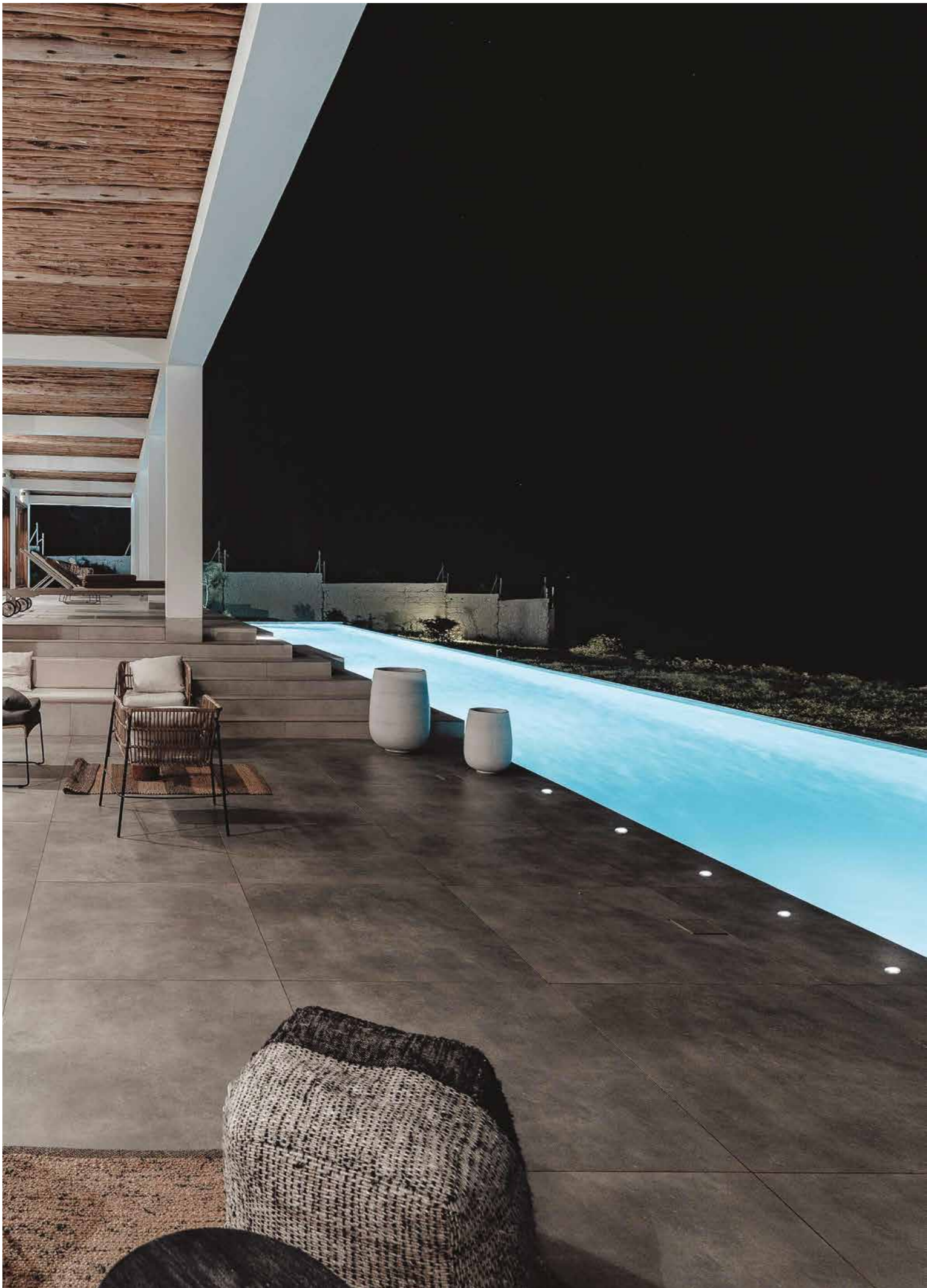

# Soft

Design U.T. EGOLUCE

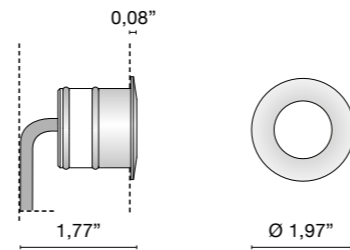

6388. \_ \_ / \_ \_ 0.24 lb

.33 ■ Stainless steel AISI 316L - *Acero cepillado*

/W 4000K LED 1,5W 12V 45lm

/WW 3000K LED 1,5W 12V 45lm



## ACCESSORIES ACCESORIOS



Plastic Box  
*Caja de plastico*

0217



Kit draining junction box + IP68  
connector  
*Kit de encofrado de drenaje +  
conector IP68*

0250

## DRIVERS CONDUCTORES

0129 Multi-power dimmable driver - 1-6 Soft

0129/DALI Multi-power DALI dimmable driver - 1-6 Soft

0159 Power supply 12V - 25W - 1-15 Soft

Only parallel connection - *Solo conexión paralelo*

OUTDOOR  
**Cerchio**

Design U.T. EgoLucé

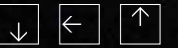

Walkable recessed spot (IP 67) with frame in stainless steel AISI 316L and aluminum heat sink. Neoprene cable 11,81" montable with or without a recessed box.

*Proyector empotrable transitable (IP 67) con marco de acero inoxidable AISI 316L y disipador de calor de aluminio. Cable de neopreno de 11,81" montable con o sin caja empotrada.*



# Cerchio

Design U.T. EGOLUCE

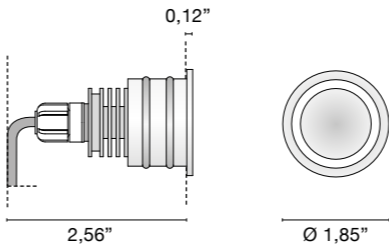

6389\_ / \_ 0.44 lb

.33 ■ Stainless steel AISI 316L - *Acero cepillado*

/W	4000K	LED max 2W 500mA	209lm
/WW	3000K	LED max 2W 500mA	199lm
/XW	2700K	LED max 2W 500mA	189lm



## ACCESSORIES ACCESORIOS



Plastic Box  
*Caja de plastico*

0217



Kit draining junction box + IP68 connector  
*Kit de encofrado de drenaje + conector IP68*

0250

## DRIVERS CONDUCTORES

0127	Drivers 500 mA - 1-6 Cerchio
0128	Drivers 350 mA - 1-10 Cerchio
0141/DIM	Multi-power dimmable driver PUSH - 1...10V - 1-11 Cerchio

0141/DALI	Multi-power DALI dimmable driver - 1-11 Cerchio
0145	Multi-power dimmable driver PUSH - 1...10V - 1-21 Cerchio
0145/DALI	Multi-power DALI dimmable driver - 1-21 Cerchio

Only serial connection - *Solo conexión serie*

# Cerchio

Design U.T. EGOLUCE

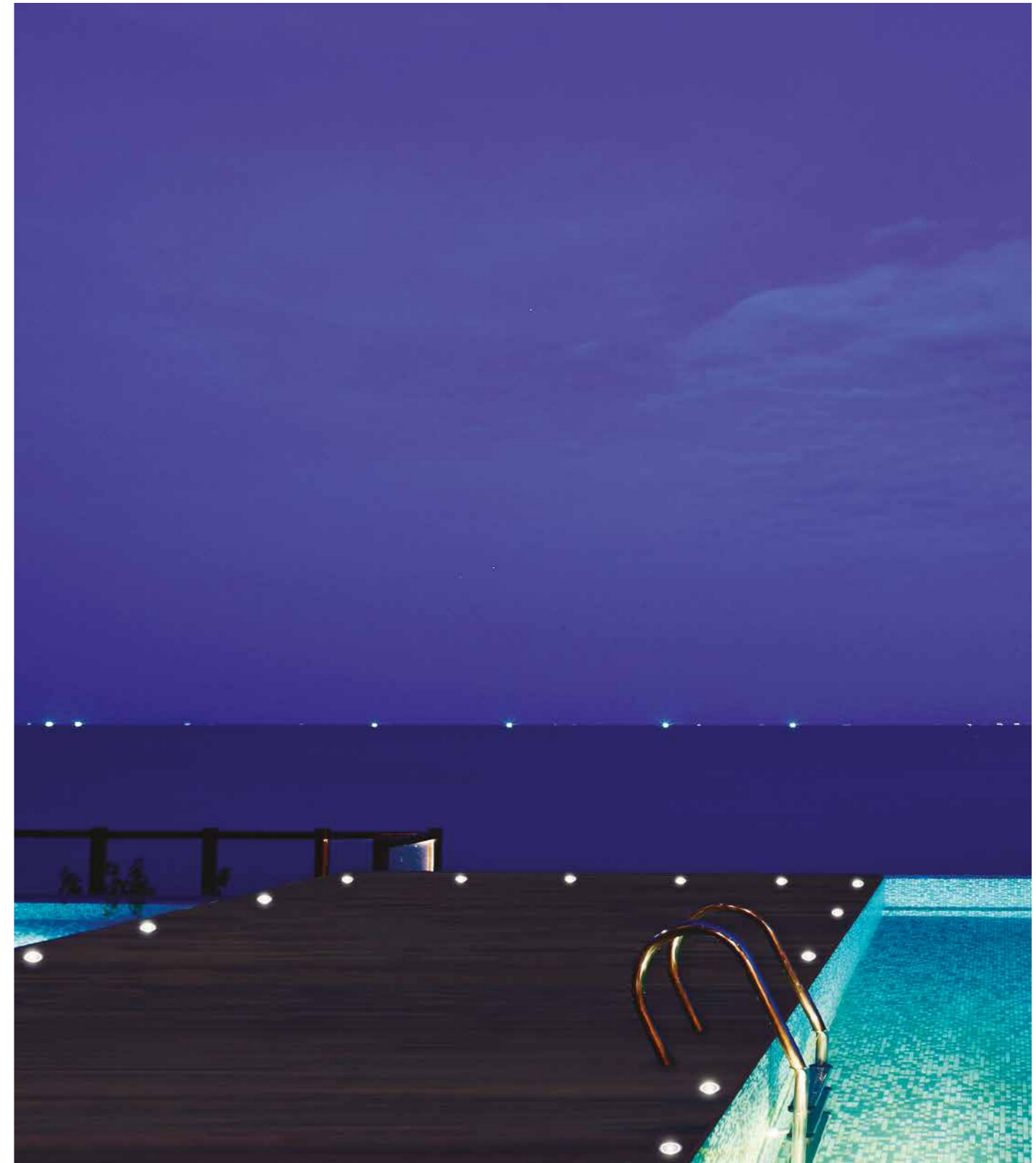
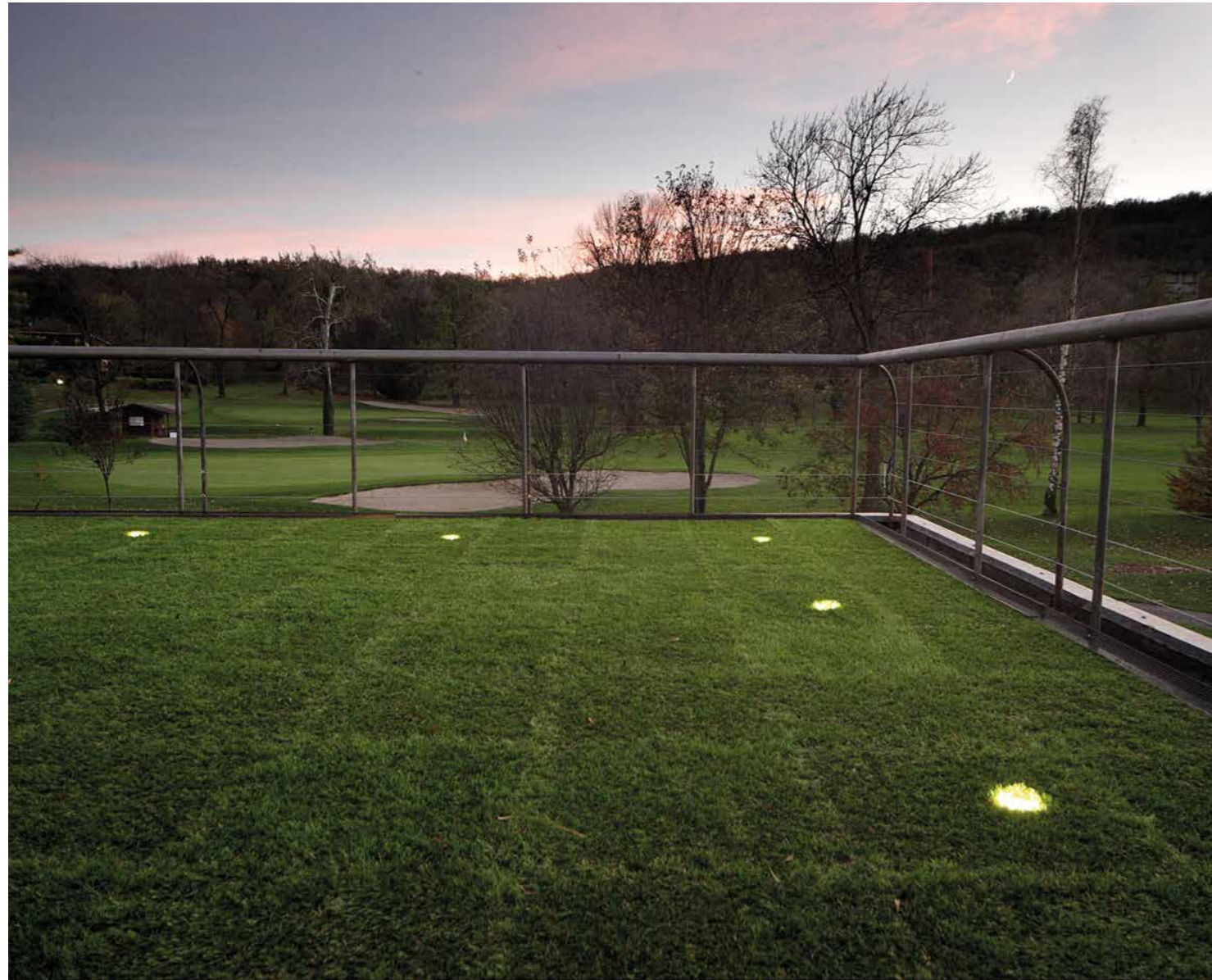
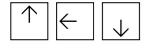



OUTDOOR  
**Vision**

Design U.T. Egoluce



Series of adjustable outdoor projectors in anodized aluminum (reinforced anodizing for outdoor) with bracket in stainless steel AISI 316L. Supplied with neoprene cable. To be installed on tile, pavements, walls, ceiling, or temporary positioning on soft grounds.

*Serie de proyectores orientables para exterior de aluminio anodizado (anodizado reforzado para exterior) con soporte de acero inoxidable AISI 316L. Se suministra con cable de neopreno. Para instalar sobre baldosas, pavimentos, paredes, techos, o para colocar temporalmente sobre suelo blando.*





# Vision 1

Design U.T. EGOLUCE

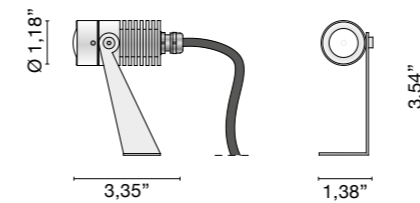

4510. \_ / \_ / \_ / \_ 0.66 lb

- .06 ■ Green - Verde
- .39 ■ Painted Anthracite finishing - Pintado antracita
- .45 ■ Aluminium anodized - Aluminio anodizado

	Optic degree					
/W	/11	/25	/45	LED max 2W 500mA	209lm	4000K
/WW	/11	/25	/45	LED max 2W 500mA	199lm	3000K
/XW	/11	/25	/45	LED max 2W 500mA	189lm	2700K



## ACCESSORIES ACCESORIOS



Stake  
Clavija

0247



IP68 Connector for cables  
Conector IP68 para cables

0243

## DRIVERS CONDUCTORES

- 0127 Drivers 500 mA - 1-6 Vision 1
- 0128 Drivers 350 mA - 1-10 Vision 1
- 0141/DIM Multi-power dimmable driver PUSH - 1...10V 500 mA - 2-8 Vision 1

- 0141/DALI Multi-power DALI dimmable driver 500 mA - 2-8 Vision 1
- 0145 Multi-power dimmable driver 500 mA - 1-21 Vision 1
- 0145/DALI Multi-power DALI dimmable driver 500 mA - 1-21 Vision 1

Only serial connection - Solo conexión serie

# Vision 3

Design U.T. EGOLUCE

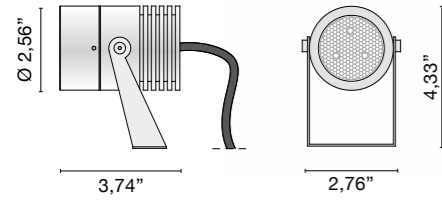

4511. \_ / \_ / \_ 1.98 lb

.06 ■ Green - Verde

.39 ■ Painted Anthracite finishing - Pintado antracita

.45 ■ Aluminium anodized - Aluminio anodizado

	Optic degree			
/W	/10 /25	LED (3x2)W 500mA	627lm	4000K
/WW	/10 /25	LED (3x2)W 500mA	597lm	3000K
/XW	/10 /25	LED (3x2)W 500mA	567lm	2700K

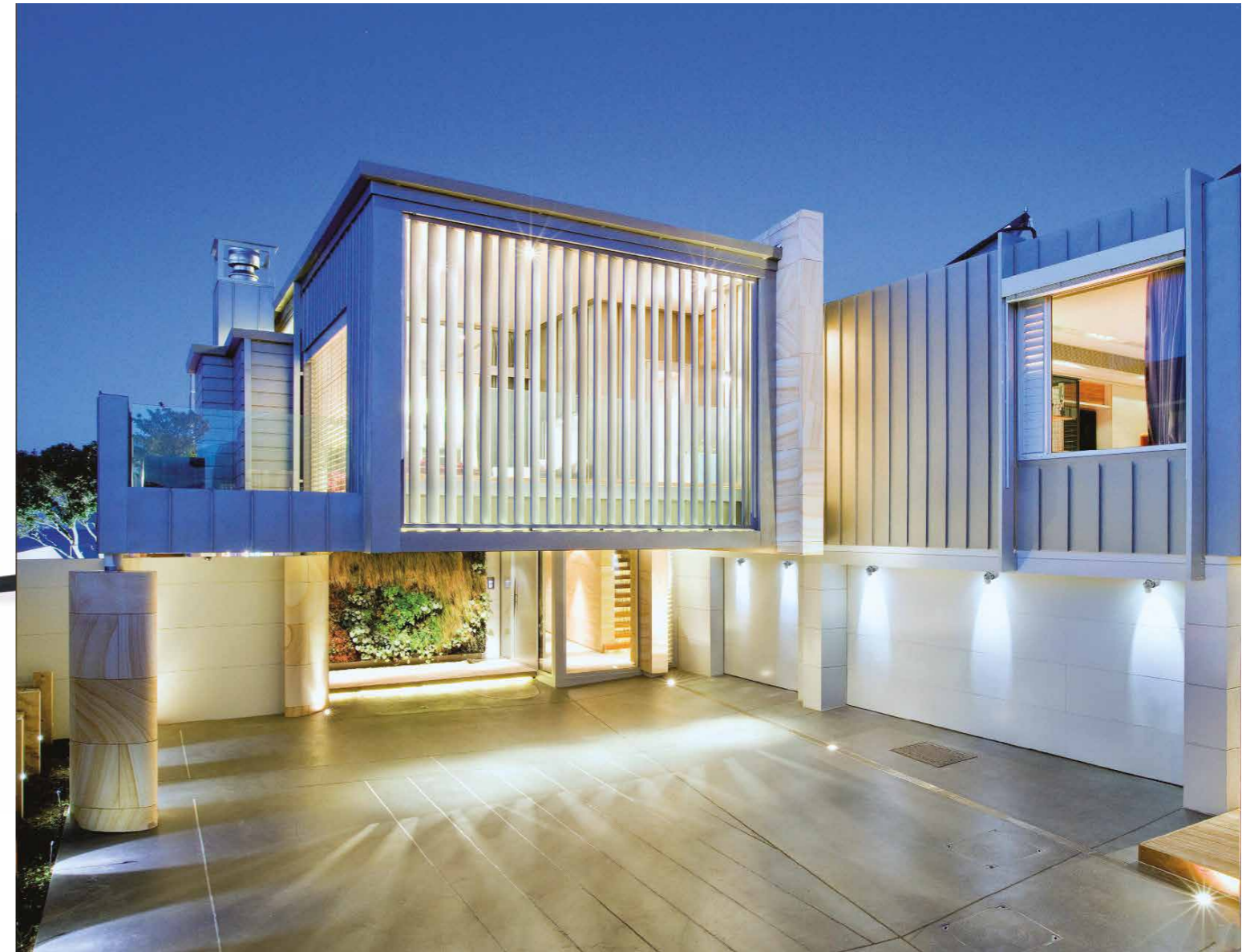

## ACCESSORIES ACCESORIOS



Stake  
Clavija para instalación temporal en el suelo

0248



IP68 Connector for cables  
Conector IP68 para cables

0243

IP68

Only serial connection - Solo conexión serie

## DRIVERS CONDUCTORES

0127 Drivers 500 mA - 1-2 Vision 3

0128 Drivers 350 mA - 1-3 Vision 3

0141/DIM Multi-power dimmable driver PUSH - 1...10V 500 mA - 1-2 Vision 3

0141/DALI Multi-power DALI dimmable driver 500 mA - 1-2 Vision 3

0145 Multi-power dimmable driver 500 mA - 1-7 Vision 3

0145/DALI Multi-power DALI dimmable driver 500 mA - 1-7 Vision 3



INDOOR

# Top

Design U.T. EgoLuce



Recessed spotlight, white painted aluminium body, heat sink included. Ideal to light up small display cases. Mounting with or without junction box.

*Foco empotrable, cuerpo de aluminio pintado en blanco, disipador de calor incluido. Ideal para iluminar pequeños escaparates. Montaje con o sin caja de conexiones.*



# Top

Design

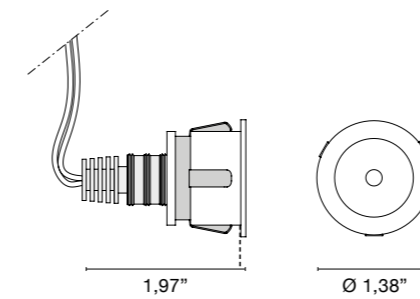
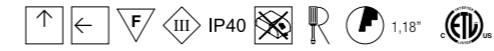

**6363**... / ... 0.09 lb

**.01** ■ White - Blanco

<b>/W</b>	4000K	LED max 2W 500mA	209lm
<b>/WW</b>	3000K	LED max 2W 500mA	199lm
<b>/XW</b>	2700K	LED max 2W 500mA	189lm



## ACCESSORIES ACCESORIOS



Plastic Box  
Caja de plastico

**0216**

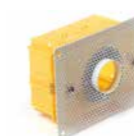

Kit: box + perforated plaster  
Kit: caja + yeso perforado

**0213**

## DRIVERS CONDUCTORES

<b>0127</b>	Drivers 500 mA - 1-6 Top
<b>0128</b>	Drivers 350 mA - 1-10 Top
<b>0141/DIM</b>	Multi-power dimmable driver PUSH - 1...10V - 1-11 Top

<b>0141/DALI</b>	Multi-power DALI dimmable driver - 1-11 Top
<b>0145</b>	Multi-power dimmable driver PUSH - 1...10V - 1-21 Top
<b>0145/DALI</b>	Multi-power DALI dimmable driver - 1-21 Top

Only serial connection - Solo conexión serie

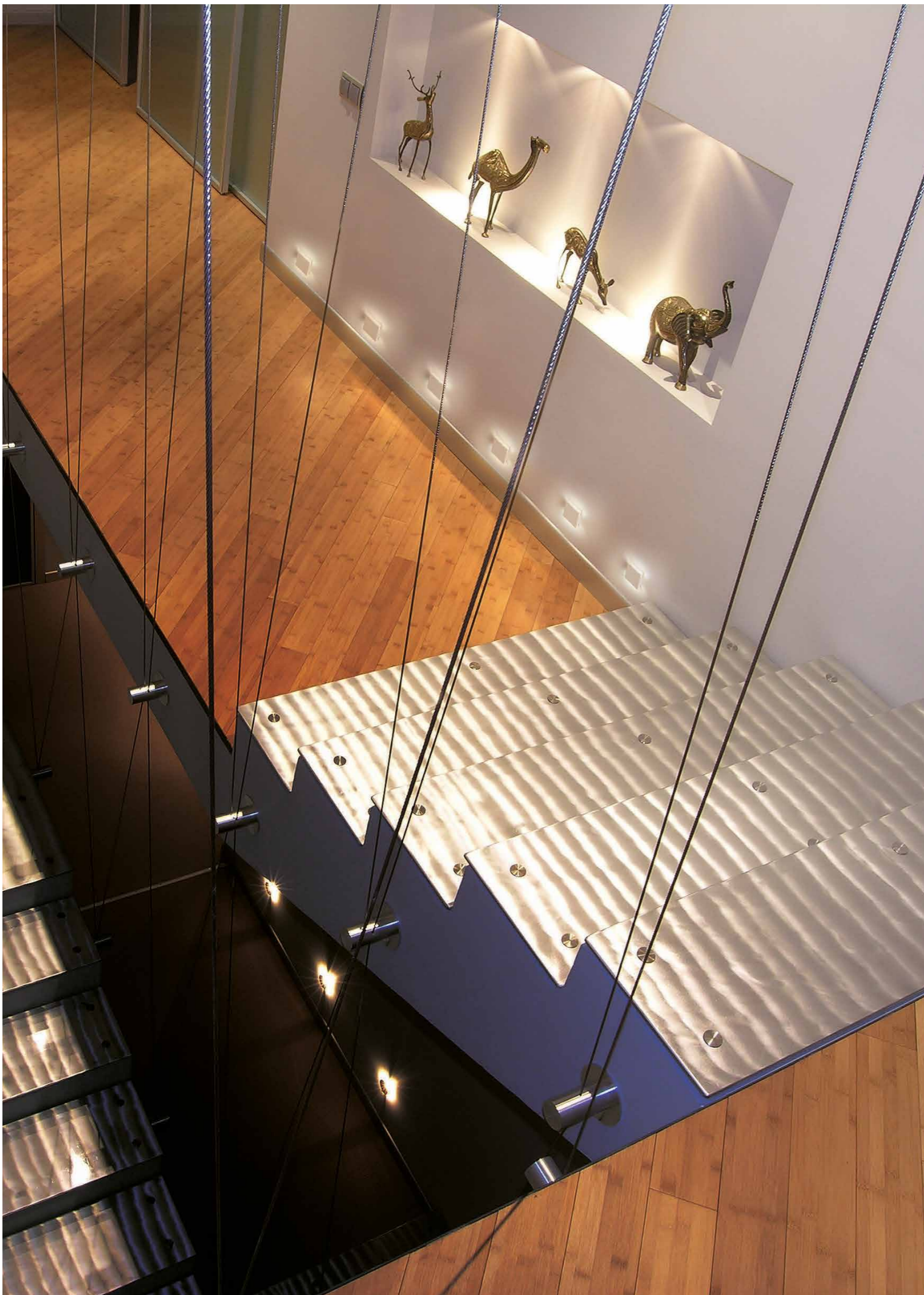

# Top Mini

Design U.T. EGOLUCE

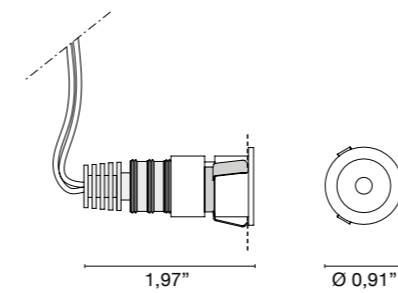
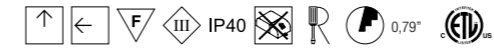

**6364** / / 0.04 lb

**.01** White - Blanco

<b>/W</b>	4000K	LED 1W 350mA	151lm
<b>/WW</b>	3000K	LED 1W 350mA	143lm
<b>/XW</b>	2700K	LED 1W 350mA	135lm



## ACCESSORIES ACCESORIOS



Plastic Box  
Caja de plastico

**0215**

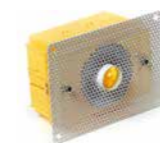

Kit: box + perforated plaster  
Kit: caja + yeso perforado

**0212**

## DRIVERS CONDUCTORES

<b>0127</b>	Drivers 500 mA - 1-6 Top mini
<b>0128</b>	Drivers 350 mA - 1-10 Top mini
<b>0141/DIM</b>	Multi-power dimmable driver PUSH - 1...10V - 1-11 Top mini

<b>0141/DALI</b>	Multi-power DALI dimmable driver - 1-11 Top mini
<b>0145</b>	Multi-power dimmable driver PUSH - 1...10V - 1-21 Top mini
<b>0145/DALI</b>	Multi-power DALI dimmable driver - 1-21 Top mini

Only serial connection - Solo conexión serie



INDOOR

# Dot

Design U.T. Egoluce



Recessed spotlight in white or nickel matt finish, heat sink included. Available in round or square version. Mounting with or without junction box or on metal false ceiling with adapter (art. 0208).

*Foco empotrable en acabado blanco o níquel mate, disipador de calor incluido. Disponible en versión redonda o cuadrada. Montaje con o sin caja de empalmes o en techo metálico con adaptador (art. 0208).*



# Dot

Design U.T. EGOLUCE

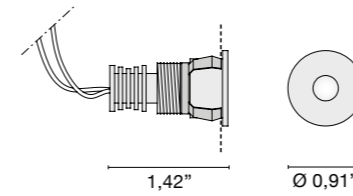
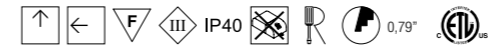

**6320.**\_\_ / \_\_ 0.04 lb

- .01** ■ White - Blanco
- .32** ■ Nickel mat - Níquel satinado

<b>/W</b>	4000K	LED 1W 350mA	151lm
<b>/WW</b>	3000K	LED 1W 350mA	143lm
<b>/XW</b>	2700K	LED 1W 350mA	138lm

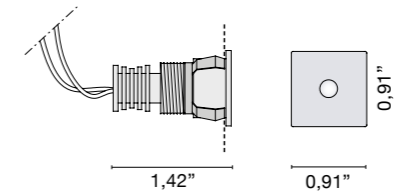

**6321.**\_\_ / \_\_ 0.04 lb

- .01** ■ White - Blanco
- .32** ■ Nickel mat - Níquel satinado

<b>/W</b>	4000K	LED 1W 350mA	151lm
<b>/WW</b>	3000K	LED 1W 350mA	143lm
<b>/XW</b>	2700K	LED 1W 350mA	138lm



## ACCESSORIES ACCESORIOS



**0208**  
Adapter for slats  
Adaptador de duelas



**0215**  
Plastic Box  
Caja de plastico



**0212**  
Kit: box + perforated plaster  
Kit: caja + yeso perforado

## DRIVERS CONDUCTORES

<b>0128</b>	Drivers 350 mA - 1-10 Dot
<b>0141/DIM</b>	Multi-power dimmable driver PUSH - 1...10V - 1-12 Dot
<b>0141/DALI</b>	Multi-power DALI dimmable driver - 1-12 Dot

<b>0145</b>	Multi-power dimmable driver PUSH - 1...10V - 1-21 Dot
<b>0145/DALI</b>	Multi-power DALI dimmable driver - 1-21 Dot

Only serial connection - Solo conexión serie

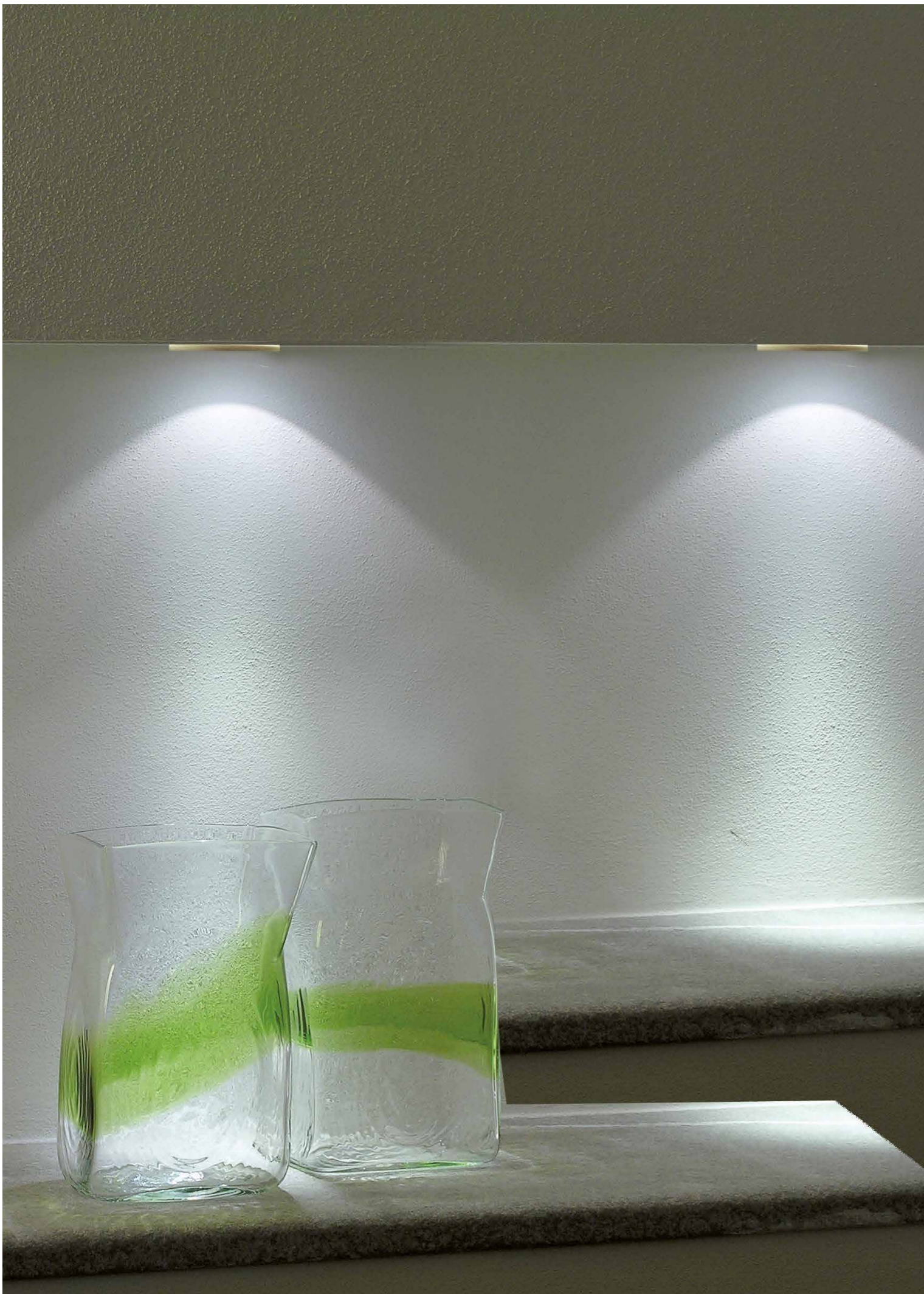

INDOOR

**Pix**

Design U.T. EgoLucé



Recessed spotlight in nickel matt finish or white painted. Heatsink included. it is available in round or square version. Installation with or without junction box and on metal false ceiling with adapter (art.0209).

*Foco empotrable en acabado níquel mate o pintado en blanco. Disipador de calor incluido. Disponible en versión redonda o cuadrada. Instalación con o sin caja de empalmes y en techo metálico con adaptador (art. 0209).*





INDOOR  
**Sirio**

Design U.T. EgoIuce

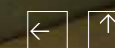

Recessed spotlight (IP 44) with clear cristal diffuser, frame in chromed aluminium. Heat sink included. Mounting with or without junction box.

*Foco empotrable (IP 44) con difusor de cristal transparente, marco de aluminio cromado. Disipador de calor incluido. Montaje con o sin caja de conexiones.*



# Sirio

Design U.T. EGOLUCE

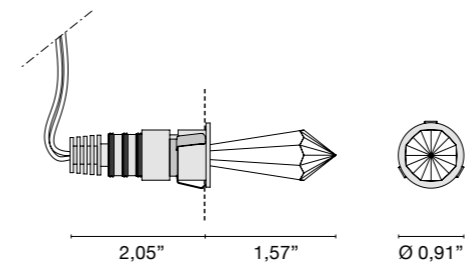

6359\_ \_ / \_ \_ 0.09 lb

.50 Crystal - Cristal

/W	4000K	LED 1W 350mA	151lm
/WW	3000K	LED 1W 350mA	143lm
/XW	2700K	LED 1W 350mA	132lm



## ACCESSORIES ACCESORIOS



Plastic Box  
Caja de plastico

0215



Kit: box + perforated plaster  
Kit: caja + yeso perforado

0212

## DRIVERS CONDUCTORES

0128	Drivers 350 mA - 1-10 Sirio
0141/DIM	Multi-power dimmable driver PUSH - 1...10V - 1-12 Sirio
0141/DALI	Multi-power DALI dimmable driver - 1-12 Sirio

0145	Multi-power dimmable driver PUSH - 1...10V - 1-21 Sirio
0145/DALI	Multi-power DALI dimmable driver - 1-21 Sirio

Only serial connection - Solo conexión serie

INDOOR

# Alcor

Design U.T. EgoIuce



Recessed spotlight (IP 44) with clear cristal diffuser, frame in chromed aluminium. Heat sink included. Mounting with or without junction box.

*Foco empotrable (IP 44) con difusor de cristal transparente, marco de aluminio cromado. Disipador de calor incluido. Montaje con o sin caja de conexiones.*



# Alcor

Design U.T. EGOLUCE

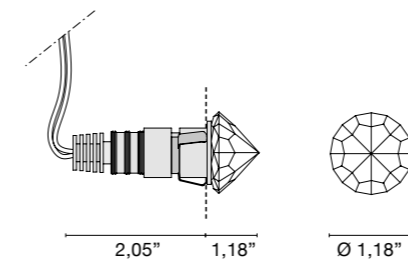
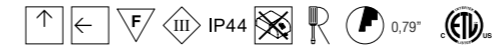

**6360** \_ \_ / \_ \_ 0.07 lb

**.50** ■ Crystal - *Cristal*

<b>/W</b>	4000K	LED 1W 350mA	151lm
<b>/WW</b>	3000K	LED 1W 350mA	143lm
<b>/XW</b>	2700K	LED 1W 350mA	132lm



## ACCESSORIES ACCESORIOS



Plastic Box  
*Caja de plastico*

**0215**



Kit: box + perforated plaster  
*Kit: caja + yeso perforado*

**0212**

## DRIVERS CONDUCTORES

<b>0128</b>	Drivers 350 mA - 1-10 Alcor
<b>0141/DIM</b>	Multi-power dimmable driver PUSH - 1...10V - 1-12 Alcor
<b>0141/DALI</b>	Multi-power DALI dimmable driver - 1-12 Alcor

<b>0145</b>	Multi-power dimmable driver PUSH - 1...10V - 1-21 Alcor
<b>0145/DALI</b>	Multi-power DALI dimmable driver - 1-21 Alcor

Only serial connection - *Solo conexión serie*

INDOOR

# Vega

Design U.T. EgoIuce

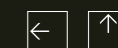

Recessed spotlight (IP 44) with clear cristal diffuser, frame in chromed aluminium. Heat sink included. Mounting with or without junction box.

*Foco empotrable (IP 44) con difusor de cristal transparente, marco de aluminio cromado. Disipador de calor incluido. Montaje con o sin caja de conexiones.*



# Vega

Design U.T. EGOLUCE

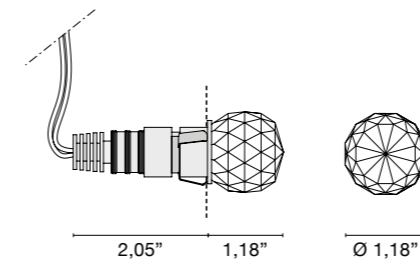

6358. \_ \_ / \_ \_ 0.13 lb

.50   Crystal - Cristal

/W	4000K	LED 1W 350mA	151lm
/WW	3000K	LED 1W 350mA	143lm
/XW	2700K	LED 1W 350mA	132lm



## ACCESSORIES ACCESORIOS



Plastic Box  
Caja de plastico

0215



Kit: box + perforated plaster  
Kit: caja + yeso perforado

0212

## DRIVERS CONDUCTORES

0128	Drivers 350 mA - 1-10 V Vega
0141/DIM	Multi-power dimmable driver PUSH - 1...10V - 5-8 Vega
0141/DALI	Multi-power DALI dimmable driver - 4-8 Vega

0145	Multi-power dimmable driver PUSH - 1...10V - 1-21 Vega
0145/DALI	Multi-power DALI dimmable driver - 1-21 Vega

Only serial connection - Solo conexión serie

INDOOR

# Fire

Design U.T. Egoluce



Recessed spotlight (IP 44). Transparent methacrylate diffuser with bubbles enclosure. Heat sink included. Mounting with or without junction box.

*Foco empotrable (IP 44). Difusor de metacrilato transparente con plástico de burbujas. Disipador de calor incluido. Montaje con o sin caja de conexiones.*





# Fire

Design U.T. EGOLUCE

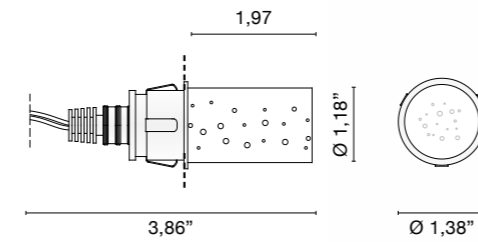

6340. \_ \_ / \_ \_ 0.18 lb

.00   Clear - *Transparente*

/W	4000K	LED 1W 350mA	151lm
/WW	3000K	LED 1W 350mA	143lm
/XW	2700K	LED 1W 350mA	138lm



## ACCESSORIES ACCESORIOS



Plastic Box  
*Caja de plastico*

0216

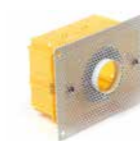

Kit: box + perforated plaster  
*Kit: caja + yeso perforado*

0213

## DRIVERS CONDUCTORES

0128	Drivers 350 mA - 1-10 Fire
0141/DIM	Multi-power dimmable driver PUSH - 1...10V - 1-11 Fire
0141/DALI	Multi-power DALI dimmable driver - 1-11 Fire

0145	Multi-power dimmable driver PUSH - 1...10V - 1-21 Fire
0145/DALI	Multi-power DALI dimmable driver - 1-21 Fire

Only serial connection - *Solo conexión serie*



INDOOR

# Ice

Design U.T. EgoLucé

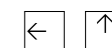

Recessed spotlight (IP44), frosted methacrylate diffuser. Heat sink included. Mounting with or without junction box.

*Foco empotrable (IP44), difusor de metacrilato satinado. Disipador de calor incluido. Montaje con o sin caja de conexiones.*

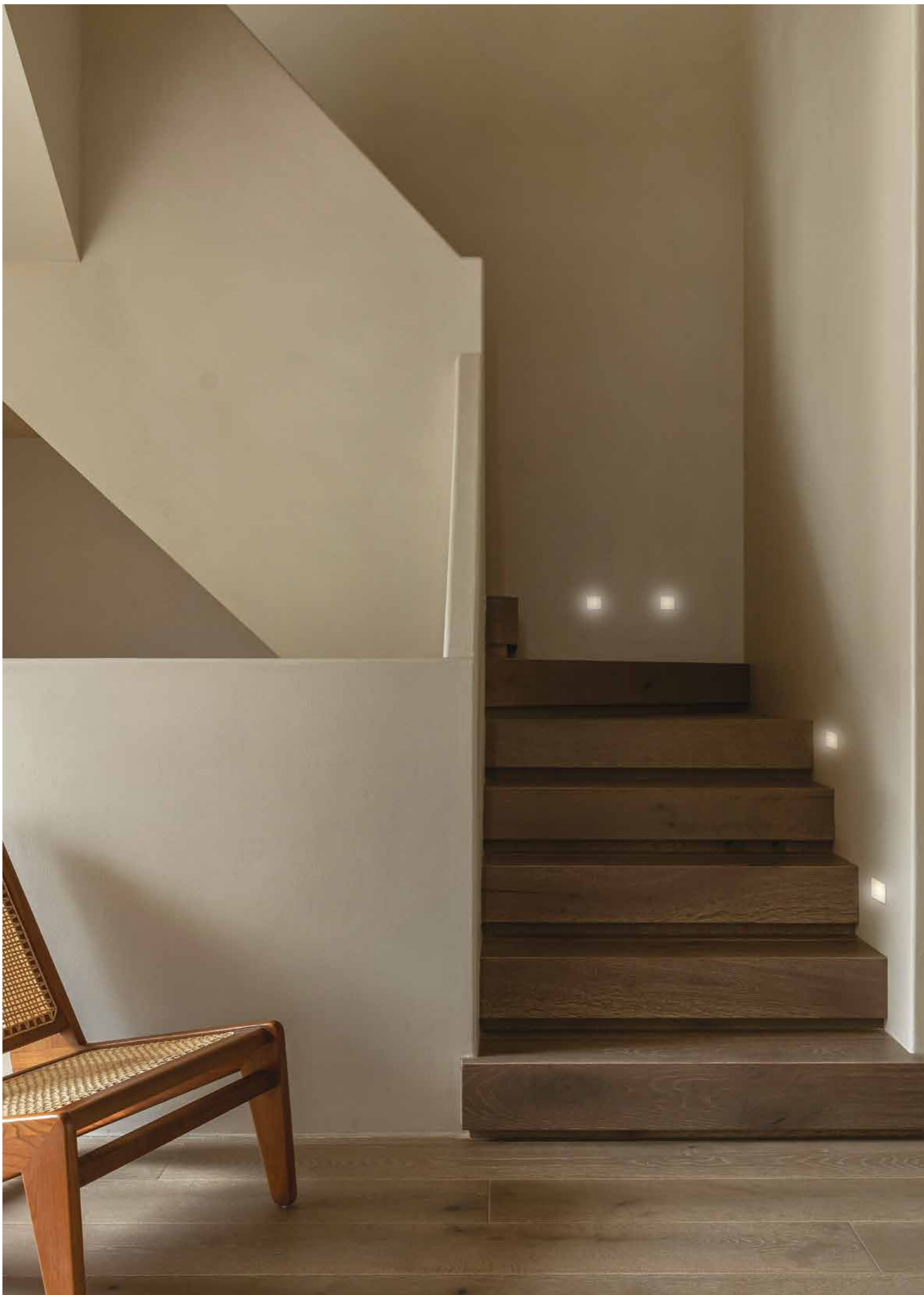

# Ice

Design U.T. EGOLUCE

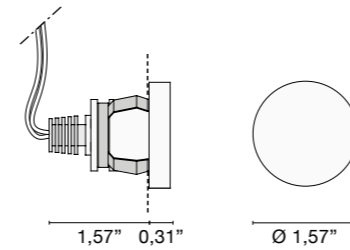

**6354**.\_ \_ / \_ \_ 0.11 lb

**.01**   White - Blanco

<b>/W</b>	4000K	LED 1W 350mA	151lm
<b>/WW</b>	3000K	LED 1W 350mA	143lm
<b>/XW</b>	2700K	LED 1W 350mA	132lm

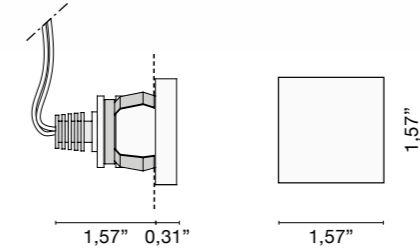

**6355**.\_ \_ / \_ \_ 0.09 lb

**.01**   White - Blanco

<b>/W</b>	4000K	LED 1W 350mA	151lm
<b>/WW</b>	3000K	LED 1W 350mA	143lm
<b>/XW</b>	2700K	LED 1W 350mA	132lm



## ACCESSORIES ACCESORIOS



Plastic Box  
Caja de plastico

**0216**

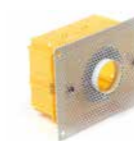

Kit: box + perforated plaster  
Kit: caja + yeso perforado

**0213**

## DRIVERS CONDUCTORES

<b>0128</b>	Drivers 350 mA - 1-10 Ice
<b>0141/DIM</b>	Multi-power dimmable driver PUSH - 1...10V - 1-12 Ice
<b>0141/DALI</b>	Multi-power DALI dimmable driver - 1-12 Ice

<b>0145</b>	Multi-power dimmable driver PUSH - 1...10V - 1-21 Ice
<b>0145/DALI</b>	Multi-power DALI dimmable driver - 1-21 Ice

Only serial connection - Solo conexión serie

INDOOR

# Snorky

Design U.T. EgoIuce



Adjustable recessed spotlight in chromed aluminium, heat sink included. The use of a latest generation Led enabled the creation of a small object with high performances. Installation with or without junction box.

*Foco empotrable orientable de aluminio cromado, con disipador de calor incluido. El uso de un LED de última generación ha permitido crear un objeto de dimensiones reducidas pero con un alto rendimiento. Instalación con o sin caja de conexiones.*



# Snorky

Design U.T. EGOLUCE

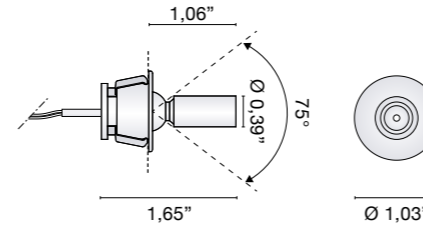

6373. \_ \_ / \_ \_ 0.04 lb

.31 ■ Chromed - Cromado

/W	4000K	LED 1W 350mA	151lm
/WW	3000K	LED 1W 350mA	143lm
/XW	2700K	LED 1W 350mA	132lm



## ACCESSORIES ACCESORIOS



Plastic Box  
Caja de plastico

0215

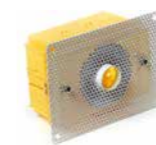

Kit: box + perforated plaster  
Kit: caja + yeso perforado

0212

## DRIVERS CONDUCTORES

0128	Drivers 350 mA - 1-10 Snorky
0141/DIM	Multi-power dimmable driver PUSH - 1...10V - 1-12 Snorky
0141/DALI	Multi-power DALI dimmable driver - 1-12 Snorky

0145	Multi-power dimmable driver PUSH - 1...10V - 1-21 Snorky
0145/DALI	Multi-power DALI dimmable driver - 1-21 Snorky

Only serial connection - Solo conexión serie



INDOOR

# Cerchietto

Design U.T. EgoLuce



Recessed spotlight (IP44), white painted aluminium body. Available with white or blue Led. Heat sink included. Mounting with or without junction box.

*Foco empotrable (IP44), cuerpo de aluminio pintado en blanco. Disponible con LED blanco o azul. Disipador de calor incluido. Montaje con o sin caja de conexiones.*



# Cerchietto

Design U.T. EGOLUCE

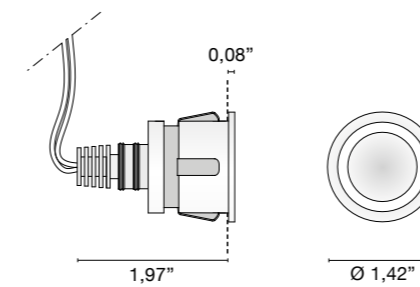

**6391.** \_ \_ / \_ \_ 0.09 lb  
**.01** ■ White - Blanco

**/B** LED 1W CRI>90 350mA  
**/W** 4000K LED max 2W CRI>90 500mA 209lm  
**/WW** 3000K LED max 2W CRI>90 500mA 199lm  
**/XW** 2700K LED max 2W CRI>90 500mA 189lm



## ACCESSORIES ACCESORIOS



Plastic Box  
Caja de plastico

**0216**

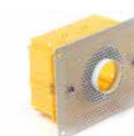

Kit: box + perforated plaster  
Kit: caja + yeso perforado

**0213**

## DRIVERS CONDUCTORES

**0127** Drivers 500 mA - 1-6 Cerchietto  
**0128** Drivers 350 mA - 1-10 Cerchietto  
**0141/DIM** Multi-power dimmable driver PUSH - 1...10V - 1-11 Cerchietto

**0141/DALI** Multi-power DALI dimmable driver - 1-11 Cerchietto  
**0145** Multi-power dimmable driver PUSH - 1...10V - 1-21 Cerchietto  
**0145/DALI** Multi-power DALI dimmable driver - 1-21 Cerchietto

Only serial connection - Solo conexión serie

INDOOR

# Cruise

Design U.T. EgoLucce

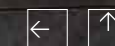

Recessed spotlight, white painted aluminium body. Heat sink included. Mounting with or without junction box.

*Foco empotrable, cuerpo de aluminio pintado en blanco. Disipador de calor incluido. Montaje con o sin caja de conexiones.*





# Cruise

Design U.T. EGOLUCE

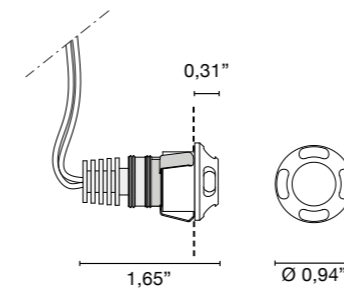

**6382**... / ... 0.04 lb

**.01** ■ White - Blanco

<b>/B</b>	LED 1W CRI>90 500mA
<b>/W</b>	4000K LED 1W CRI>90 500mA 151lm
<b>/WW</b>	3000K LED 1W CRI>90 500mA 143lm
<b>/XW</b>	2700K LED 1W CRI>90 500mA 135lm



## ACCESSORIES ACCESORIOS



Plastic Box  
Caja de plastico

**0215**



Kit: box + perforated plaster  
Kit: caja + yeso perforado

**0212**

## DRIVERS CONDUCTORES

<b>0128</b>	Drivers 350 mA - 1-10 Cruise
<b>0141/DIM</b>	Multi-power dimmable driver PUSH - 1...10V - 1-12 Cruise
<b>0141/DALI</b>	Multi-power DALI dimmable driver - 1-12 Cruise

<b>0145</b>	Multi-power dimmable driver PUSH - 1...10V - 1-21 Cruise
<b>0145/DALI</b>	Multi-power DALI dimmable driver - 1-21 Cruise

Only serial connection - Solo conexión serie

INDOOR

# Spoon

Design U.T. EgoLucé



Recessed spotlight for asymmetric emission. Aluminium frame in anodized or white finish. Heat sink included. Mounting with junction box.

*Foco empotrado para emisión asimétrica. Estructura de aluminio anodizado o blanco. Disipador de calor incluido. Montaje con caja de conexiones.*



# Spoon

Design U.T. EGOLUCE

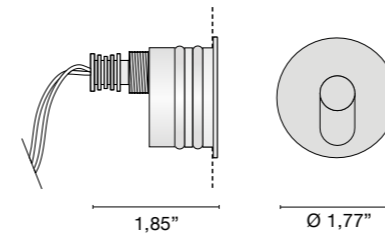
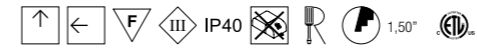

**6350**... / ... 0.15 lb

- .01** ■ White - Blanco
- .45** ■ Aluminium anodized - Aluminio anodizado

<b>/W</b>	4000K	LED max 2W 500mA	209lm
<b>/WW</b>	3000K	LED max 2W 500mA	199lm
<b>/XW</b>	2700K	LED max 2W 500mA	189lm

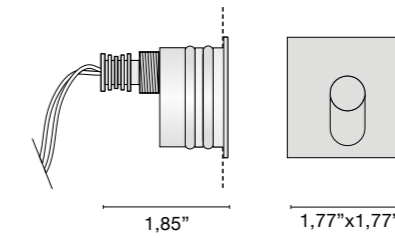

**6351**... / ... 0.15 lb

- .01** ■ White - Blanco
- .45** ■ Aluminium anodized - Aluminio anodizado

<b>/W</b>	4000K	LED max 2W 500mA	209lm
<b>/WW</b>	3000K	LED max 2W 500mA	199lm
<b>/XW</b>	2700K	LED max 2W 500mA	189lm



## ACCESSORIES ACCESORIOS



Plastic Box  
Caja de plastico

**0217**



Kit: box + perforated plaster  
Kit: caja + yeso perforado

**0214**

## DRIVERS CONDUCTORES

<b>0127</b>	Drivers 500 mA - 1-6 Spoon tondo
<b>0128</b>	Drivers 350 mA - 1-10 Spoon tondo
<b>0141/DIM</b>	Multi-power dimmable driver PUSH - 1...10V - 1-11 Spoon

<b>0141/DALI</b>	Multi-power DALI dimmable driver - 1-11 Spoon
<b>0145</b>	Multi-power dimmable driver PUSH - 1...10V - 1-21 Spoon
<b>0145/DALI</b>	Multi-power DALI dimmable driver - 1-21 Spoon

Only serial connection - Solo conexión serie

# Spoon

Design U.T. EgoLucce

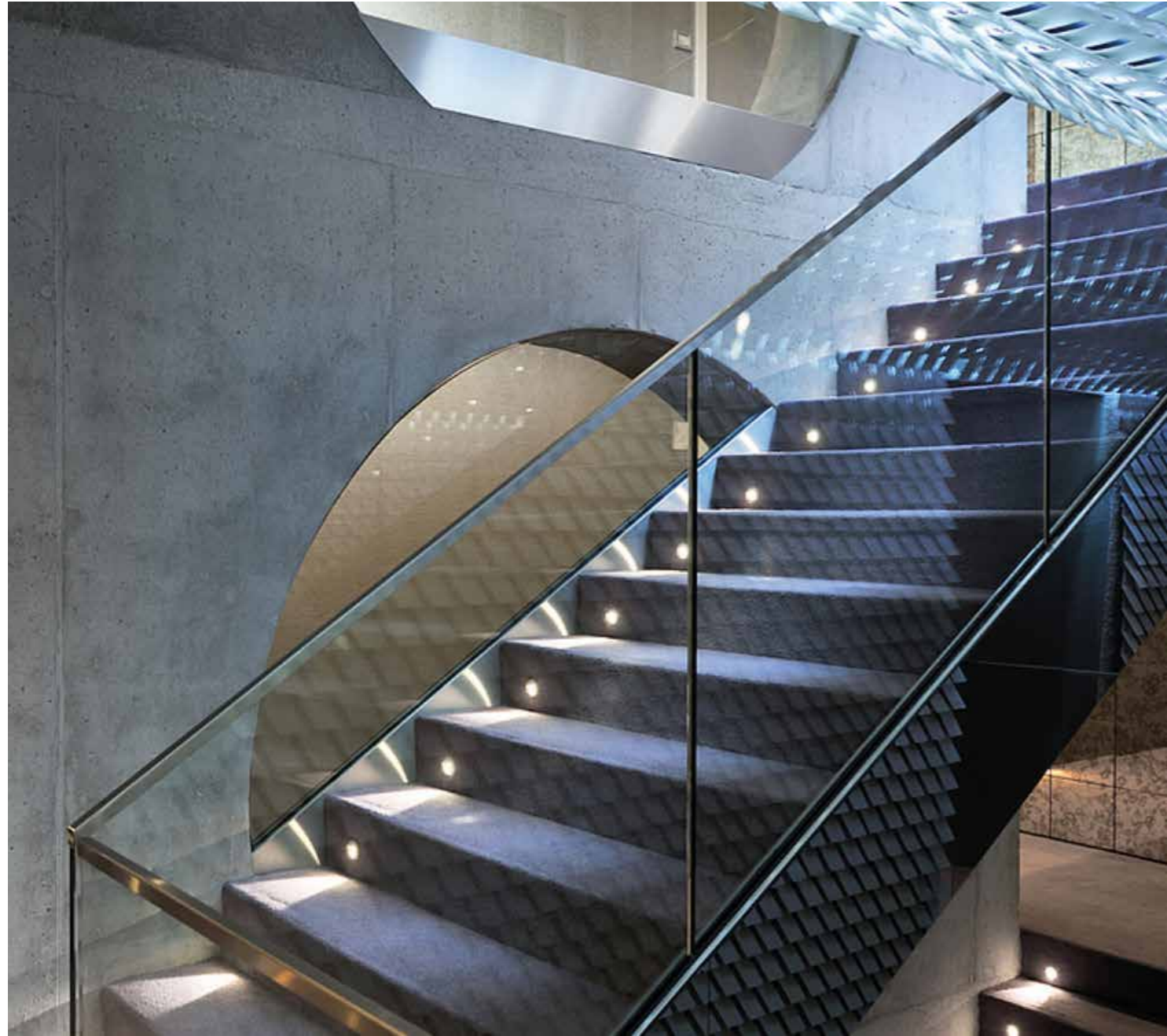

# Spoon

Design U.T. Egluce





INDOOR  
**Slot**

Design U.T. EgoLucé



Recessed spotlight for asymmetric light, metal frame in white finish. Heat sink included.  
Mounting with or without junction box.

*Foco empotrable con luz asimétrica, estructura metálica con acabado en blanco.  
Disipador de calor incluido. Montaje con o sin caja de conexiones.*

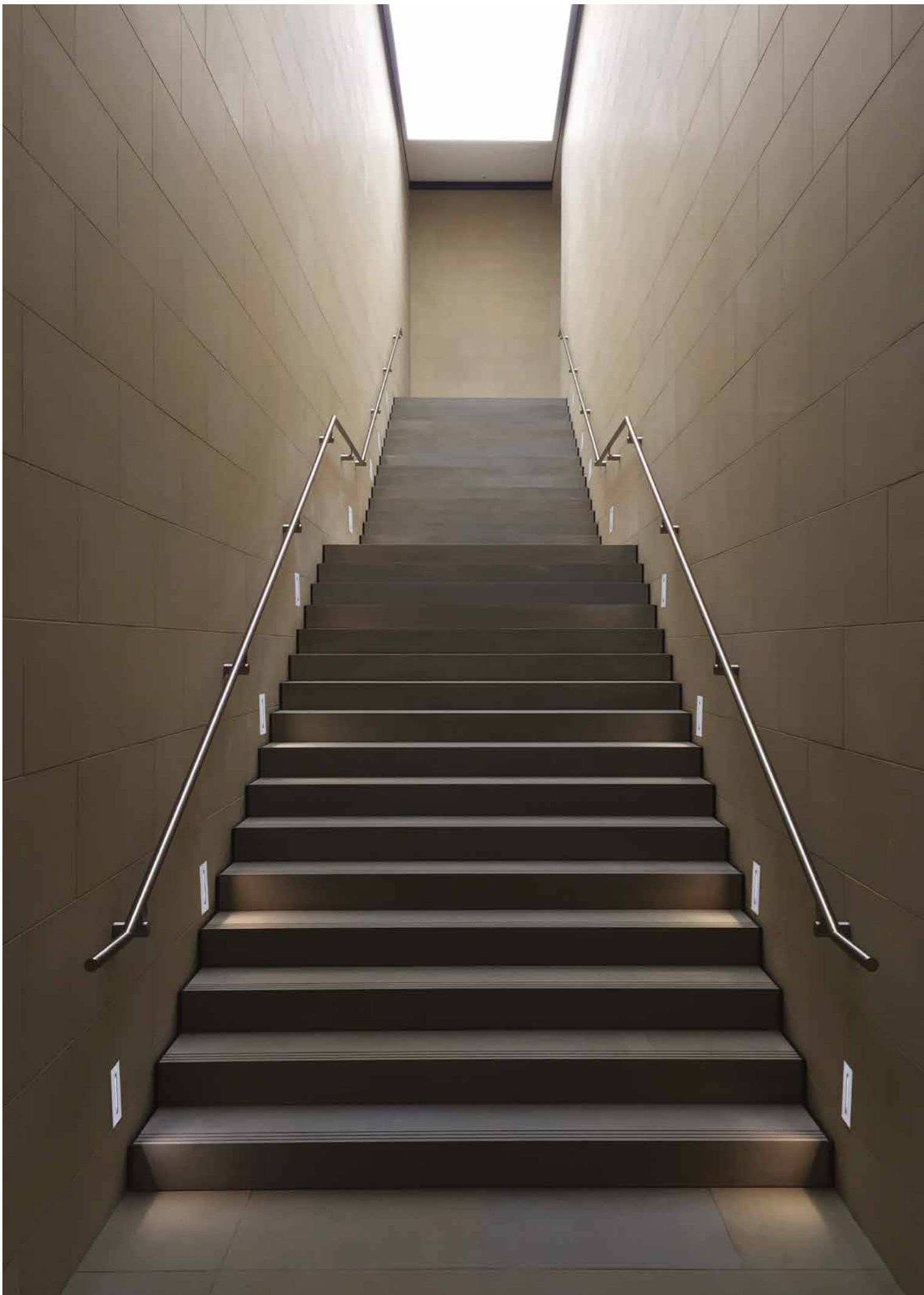

# Slot

Design U.T. EGOLUCE

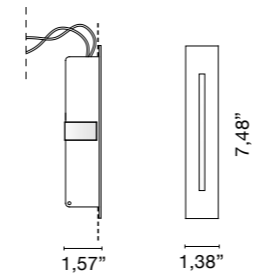
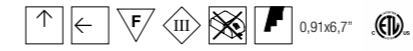

**6381** \_ \_ / \_ \_ 0.44 lb

**.01** ■ White - Blanco

<b>/W</b>	4000K	LED 1W CRI>90	350mA	151lm
<b>/WW</b>	3000K	LED 1W CRI>90	350mA	143lm
<b>/XW</b>	2700K	LED 1W CRI>90	350mA	135lm



## ACCESSORIES ACCESORIOS



Box + plaster  
Caja + yeso

**0249**

## DRIVERS CONDUCTORES

<b>0128</b>	Drivers 350 mA - 1-10 Slot
<b>0141/DIM</b>	Multi-power dimmable driver PUSH - 1...10V - 1-12 Slot
<b>0141/DALI</b>	Multi-power DALI dimmable driver - 1-12 Slot

<b>0145</b>	Multi-power dimmable driver PUSH - 1...10V - 1-21 Slot
<b>0145/DALI</b>	Multi-power DALI dimmable driver - 1-21 Slot

Only serial connection - Solo conexión serie



# Technology

## *Tecnología*

### General informations

#### *Información general*

Our power LED must be powered **ONLY** with low voltage direct current **ONLY IN SERIAL CONNECTION**. Our converters are predisposed for this kind of connection.

We recommend not to exceed 21,87yd of circuit length between converter and LED. Connect all elements before to give tension to the circuit.

Respect correct polarity when connecting.

We strongly recommend to avoid installation of switches between converter and LED.

*Nuestros LEDs de potencia deben alimentarse SÓLO con corriente continua de bajo voltaje y conectarse EN SERIE. Nuestras fuentes de alimentación están diseñadas para esta conexión.*

*Se recomienda no superar los 21,87yd. de longitud de cables entre el balasto y el LED. Conectar todos los focos antes de alimentar el circuito.*

*Observe las polaridades en la conexión eléctrica para una correcta funcionamiento correcto.*

*Se desaconseja encarecidamente instalar interruptores entre fuente de alimentación y LED.*



# REGULACIÓN 1...10V & PUSH PARA COB Y POWER LED

Multi-power drivers supplied with dip-switch for selection of the output current.

Light regulation 0-100% by means of PUSH function, 1...10V interface.

**Art. 0133** synchronization cable is sold separately, one commanded master driver can synchronize up to max. 9 slaves

*Fuentes de alimentación multipotencia equipadas con interruptores DIP para seleccionar la corriente de salida.*

*Ajuste de luminosidad 0-100% mediante función PUSH, interfaz 1...10V.*

**Art. 0133** cable de sincronización suministrado por separado; máx. 10 alimentadores sincronizados, de los cuales sólo se controla uno. (1 Amo + 9 Esclavos)

## 1...10 V

For light regulation 1...10V the control systems are provided of active terminal connection.

*Para la regulación a través de 1...10V, el sistema dispone de un terminal activo específico.*

## PUSH

Light regulation by means of PUSH function.

A short push to turn on and off; a longer push to increase or decrease light intensity. Regulation automatically stops at minimum and maximum values. For another on, regulation or off command, release the push button and give the desired command again.

Attention: only use normally open push buttons with no incorporated warning light.

0145

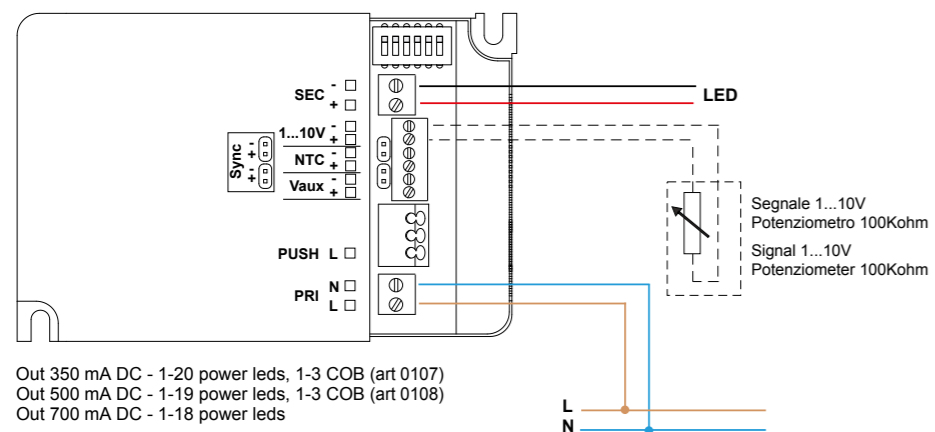
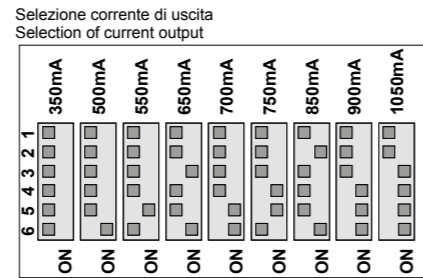

0145

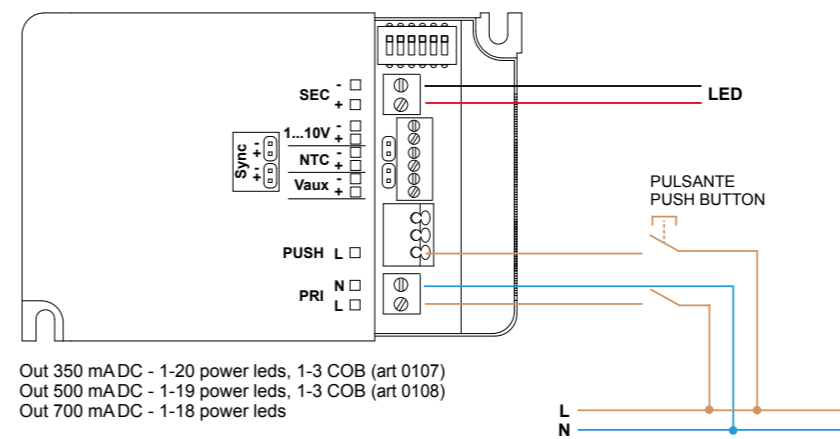
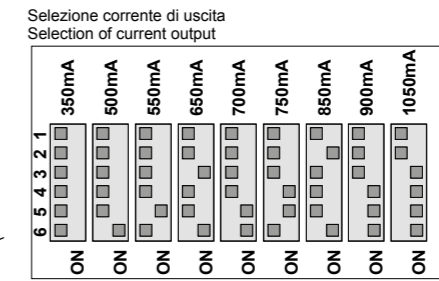

# DALI DIMMING PARA COB Y POWER LED



Multi-power drivers supplied with dip-switch for selection of the output current.

Features DALI dimming (0,5-100%):

- memory function for sets or light groups
- recall of stored functions
- compatible with standard DALI interfaces

**Art. 0133** synchronisation cable supplied separately; max. 10 synchronised power supplies, of which only one is controlled.

Balastos multipotencia equipados con interruptores DIP para la selección de la corriente de salida.

Funciones de regulación DALI (0,5-100%):

- función de memoria para escenas o grupos de iluminación
- recuperación de funciones almacenadas
- compatibilidad con interfaces estándar DALI

**Art. 0133** synchronisation cable is sold separately, one commanded master driver can synchronise up to max. 9 slaves



0129/DALI



0145/DALI

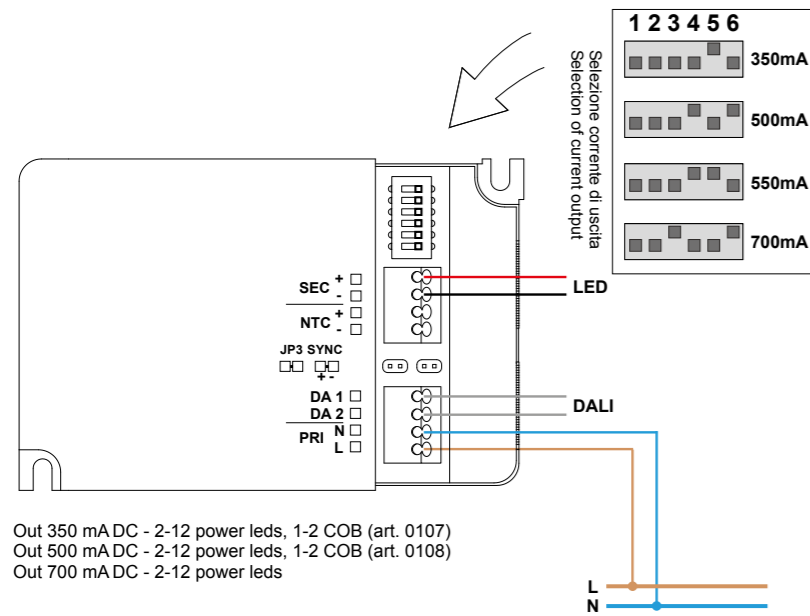

Out 350 mA DC - 2-12 power leds, 1-2 COB (art. 0107)  
Out 500 mA DC - 2-12 power leds, 1-2 COB (art. 0108)  
Out 700 mA DC - 2-12 power leds

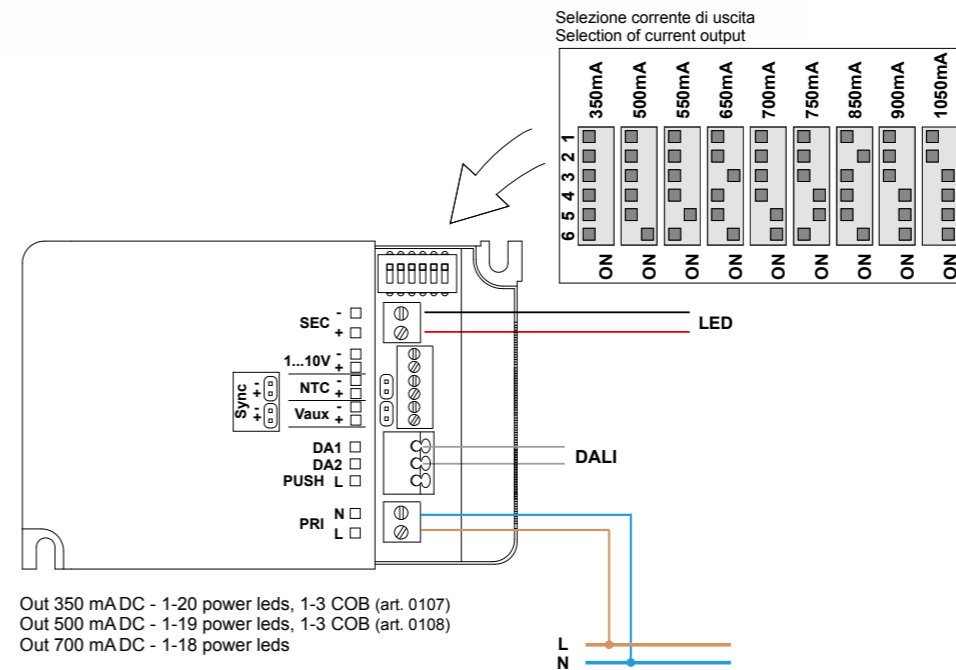

Out 350 mA DC - 1-20 power leds, 1-3 COB (art. 0107)  
Out 500 mA DC - 1-19 power leds, 1-3 COB (art. 0108)  
Out 700 mA DC - 1-18 power leds

# Installations / Instalaciones

0220 - 0228 - 0250 - 0251

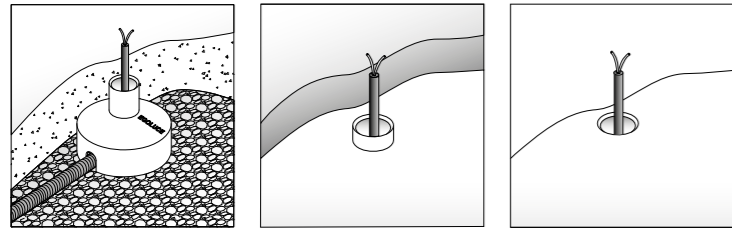

0230 - 0231

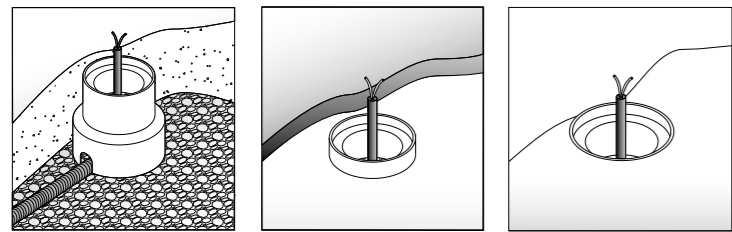

0229

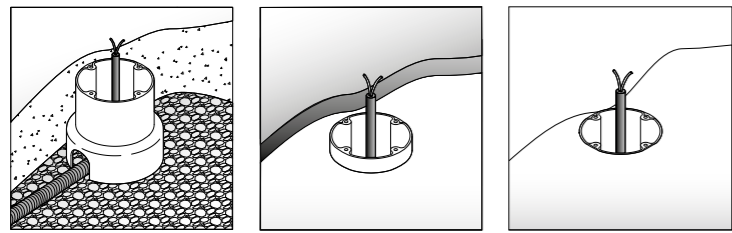

6615 - 6616 - 6617 - 6618

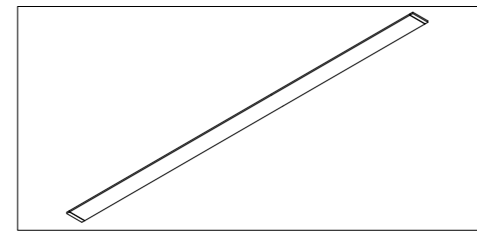
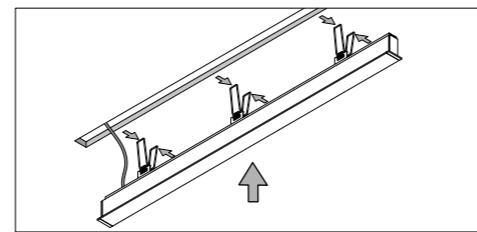
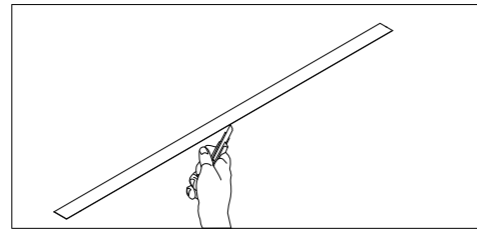

0249

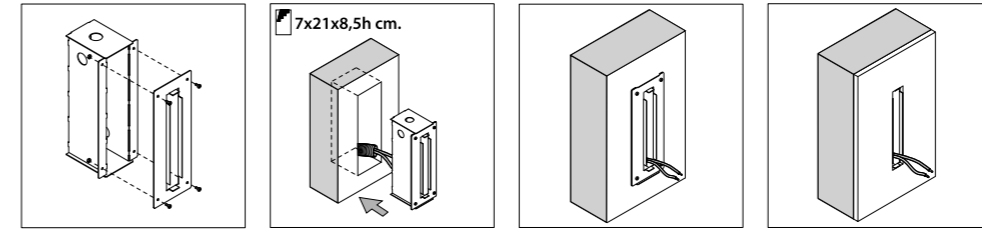

0212 - 0213 - 0214

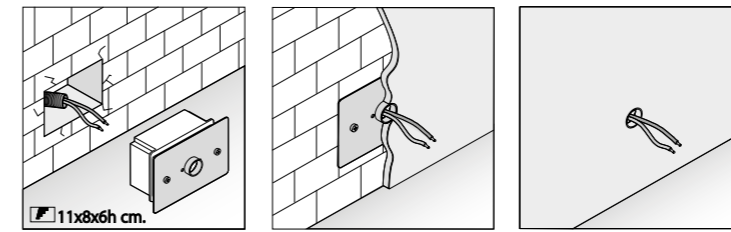

0215 - 0216 - 0217 - 0232

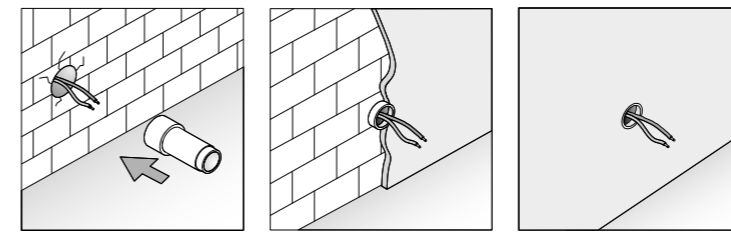

0234

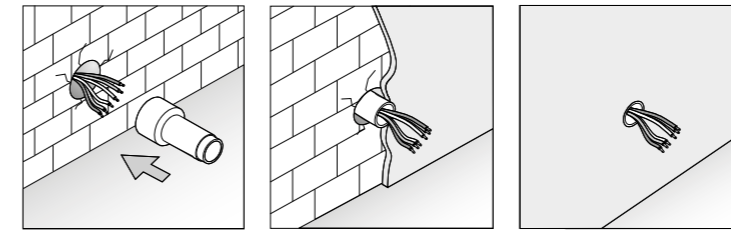

0298 - 0299

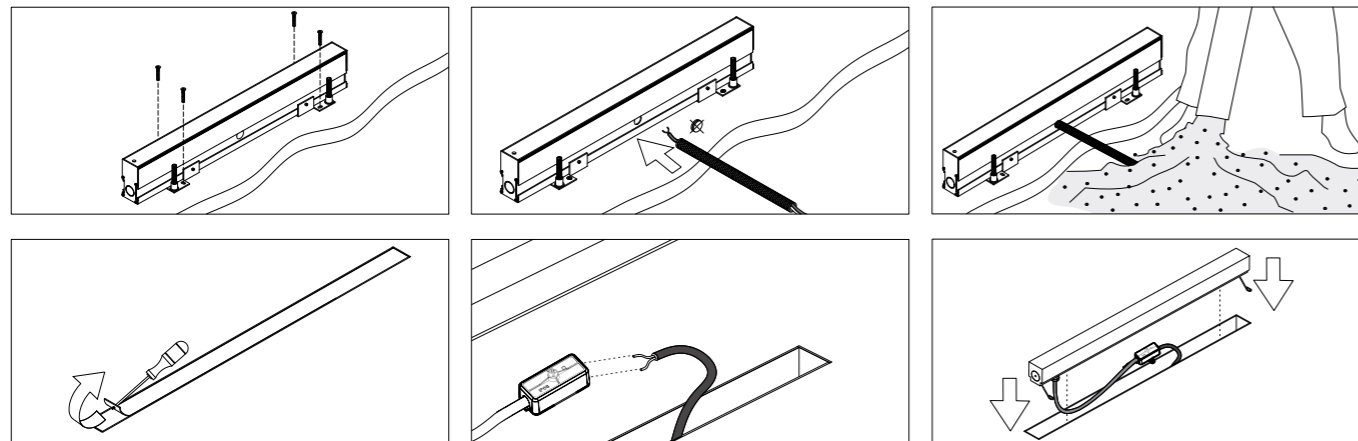

# Accessories / Accesorios

## 0216

Plastic Box  
Caja de plástico

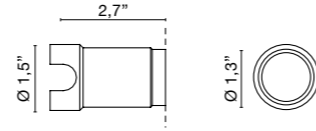

Zeppelin, Zeppelin 25 Plus, Kross, Vista, Fire, Ice, Top, Cerchietto, Joy

## 0220

Kit draining junction box + IP68 connector  
Kit de encofrado de drenaje + conector IP68

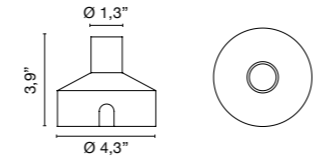

Zeppelin, Zeppelin 25 Plus, Kross, Vista

## 0230

Kit draining junction box + IP68 connector  
Kit de encofrado de drenaje + conector IP68

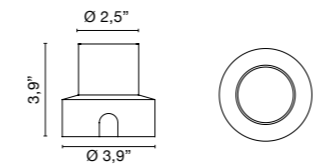

Zeppelin Maxi, Zeppelin turnable

## 0232

Wall Plastic Box  
Encofrado de muros

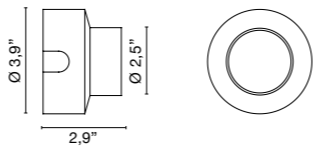

Zeppelin Maxi, Zeppelin turnable, Step

## 0260

Spring for plasterboar  
Accesorio de montaje en cartón yeso



2,36"

Zeppelin Maxi

## 0238

Spring for plasterboar  
Accesorio de montaje en cartón yeso



2,36"

Zeppelin turnable

## 0210/100

Recessed box 40,7"  
Encofrado 40,07"

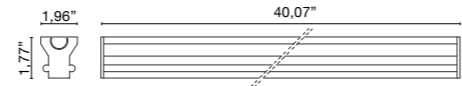

Linea

## 0210/150

Recessed box 59,76"  
Encofrado 59,76"

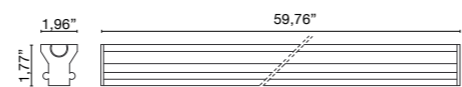

Linea

## 0242/100

Optional L shaped profile to ease installation into plasterboard 39,37"  
Perfil angular opcional para facilitar la instalación en cartón yeso 39,37"

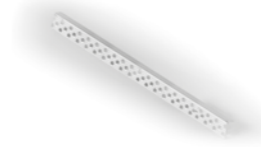

Linea

## 0267

Louvres  
Lightbreak



Newton Spots, Newton Track 48V

## 0274

Anti-glare screen  
Pantalla antirreflejos



Newton Spots, Newton Track 48V

## 0265

Sand-blasted Pirex glass diffuser  
Difusor de vidrio Pyrex arenado



Newton Spots Slim, Newton Slim Track 48V

## 0264

Decorative parabolic reflector  
Parábola decorativa



Newton Spots Flat, Newton Flat Track 48V

## 0247

Stake  
Clavija

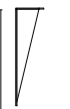

Vision 1

## 0243

IP68 Connector for cables  
Conector IP68 para cables

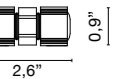

Vision 1, Vision 3

## 0248

Stake  
Clavija para instalación temporal en el suelo



Vision 3

# Accessories / Accessorios

**0231**

Kit draining junction box + IP connector  
Kit de encofrado de drenaje + conector IP

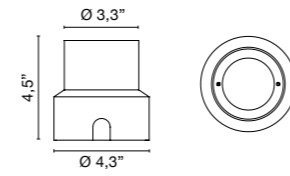

Tris

**0235**

Wall Plastic Box  
Encofrado de muros

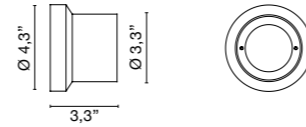

Tris

**0233**

Spring for plasterboard  
Accesorio de montaje en cartón yeso



3,35"

Tris

**0217**

Plastic Box  
Caja de plastico

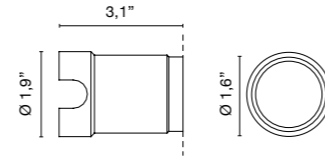

Soft, Cerchio, Spoon

**0250**

Kit draining junction box + IP68 connector  
Kit de encofrado de drenaje + conector IP68

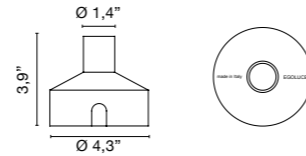

Soft, Cerchio

**0229**

Kit draining junction box + IP68 connector  
Kit de encofrado de drenaje + conector IP68

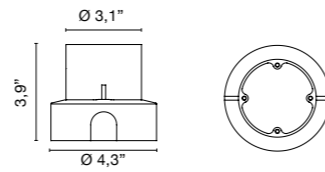

Drive

**0208**

Adapter for slats  
Adaptador de duelas

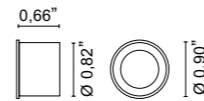

Dot

**0215**

Plastic Box  
Caja de plastico

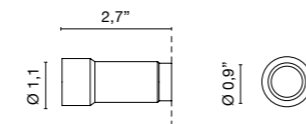

Dot, Sirio, Alcor, Vega, Top Mini, Snorky, Cruise

**0212**

Kit: box + perforated plaster  
Kit: caja + yeso perforado

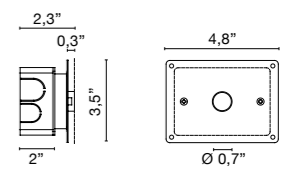
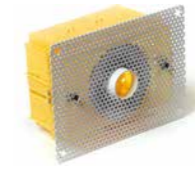

Dot, Sirio, Alcor, Vega, Top Mini, Snorky, Cruise

**0213**

Kit: box + perforated plaster  
Kit: caja + yeso perforado

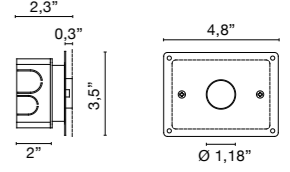

Fire, Ice, Top, Pix, Cerchietto, Joy

**0209**

Adapter for slats  
Adaptador de duelas

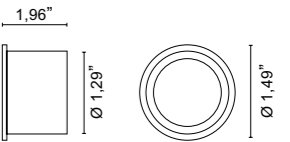

Pix

**0234**

Plastic Box  
Caja de plastico

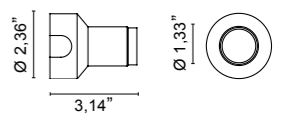

Pix

**0214**

Kit: box + perforated plaster  
Kit: caja + yeso perforado

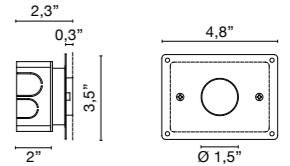

Spoon

**0249**

Box + plaster  
Caja + yeso

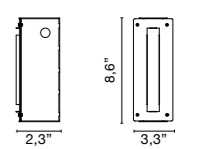

Vision 1, Vision 3, Tris, Step, Slot

**7521.\_ \_**

Aluminium wall base with cover disc  
Base mural de aluminio con disco de cubierta de base

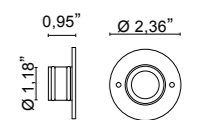

**.01** ■ White - Blanco

**.02** ■ Black - Negro

**.06** ■ Green - Verde

**.33** ■ Stainless steel AISI 316L - Acero cepillado

**.34** ■ Painted corten finishing - Corten pintado

Joy

# Accessories / Accesorios

## 0246/R

Box + plate with steel screws  
Caja + placa con tornillos de acero



Joy

## 7510.\_ \_

Junction element  
Elemento de unión

.02 ■ Black - Negro



Joy

## 0228/R

Draining box  
Encofrado drenante



Joy

## 7522.\_ \_

Base with cover disc  
Base con disco de cubierta de base

.01 ■ White - Blanco

.02 ■ Black - Negro

.06 ■ Green - Verde

.33 ■ Stainless steel AISI 316L - Acero cepillado

.34 ■ Painted corten finishing - Corten pintado

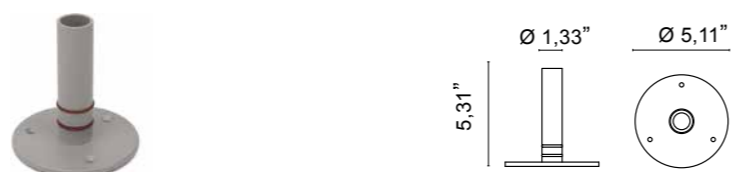

Joy

# Numerical index / Índice numérico

code / código	product / producto	pag.	code / código	product / producto	pag.
1665	Wanda System	212	6722	Tiny - 24V track products	94
1690	Lara Maxi	195	6723	Tiny - 24V track products	94
2550	Lara	191	6724	Tiny - 24V track products	94
2552	Lara Maxi	193	6725	Tiny - 24V track products	94
2553	Lara Maxi	193	7516	Joy	170
4510	Vision 1	289	U1540	Lancia	43
4511	Vision 3	290	U1562	Lancia Tonda	16
4536	Wanda	202	U1563	Lancia Tonda	16
4537	Wanda	202	U1564	Lancia Tonda	16
4672	Joy	176	U1566	Lancia Tonda	16
4673	Joy	176	U1567	Lancia di Achille	58
5690	Joy	176	U1570	Radar	72
6320	Dot	301	U1571	Radar	72
6321	Dot	301	U1572	Radar	72
6322	Pix	305	U1573	Lancia Tonda System	18
6323	Pix	305	U1574	Lancia Tonda System	19
6340	Fire	321	U1575	Lancia Tonda XL/XXL	22
6348	Zeppelin	243	U1576	Lancia Tonda XL/XXL	22
6349	Zeppelin	243	U1580	Stick system	147
6350	Spoon	341	U1581	Stick system	147
6351	Spoon	341	U1582	Stick system	147
6354	Ice	325	U1591	Newton System	136
6355	Ice	325	U1592	Newton System	136
6358	Vega	317	U1673	Lancia no limits	50
6359	Sirio	309	U1674	Matita	65
6360	Alcor	313	U1675	Matita	65
6361	Kross	270	U2513	Lancia Tonda	35
6362	Vista	265	U2514	Lancia Tonda	35
6363	Top	295	U3513	Lancia Tonda	36
6364	Top Mini	297	U3514	Lancia Tonda	36
6366	Drive	261	U4582	Moonlight	79
6368	Zeppelin Maxi	247	U4583	Moonlight	79
6369	Step	275	U4620	Moonlight	79
6371	Tris	257	U6342	Newton Spots	112
6373	Snorky	329	U6343	Newton Track 48V	124
6381	Slot	349	U6344	Newton Spots	112
6382	Cruise	337	U6345	Newton Track 48V	124
6383	Zeppelin Maxi	247	U6346	Newton Track 48V	124
6384	Zeppelin 25 Plus	245	U6448	Newton Flat Track 48V	130
6387	Step	275	U6449	Newton Flat Track 48V	130
6388	Soft	279	U6450	Newton Flat Track 48V	130
6389	Cerchio	283	U6451	Newton Slim Track 48V	128
6391	Cerchietto	333	U6452	Newton Slim Track 48V	128
6394	Zeppelin 25 Plus	245	U6468	Newton Spots Flat	123
6397	Zeppelin COB	250	U6469	Newton Spots Flat	123
6411	Zeppelin turnable	253	U6470	Newton Spots Slim	118
6417	Spooky	232	U6471	Newton Spots Slim	118
6418	Spooky	232	U7341	Track 48V	132
6419	Spooky	232	U7342	Track 48V	132
6615	Linea	157	U7343	Track 48V	132
6616	Linea	157			



Our fittings are manufactured in conformity with the european standard CEI-EN 60598 and, consequently, get the mark CE.

*Nuestros productos se fabrican de conformidad con las normas europeas CEI-EN 60598 y, como tales, llevan el marcado CE.*

---

Egoluce s.r.l. reserves the right to change, at any time and without prior warning, the technical specification of any product illustrated in this catalogue.  
Colours are simply indicative of the real nuance.

*Egoluce s.r.l. se riserva el derecho de modificar, en cualquier momento y sin previo aviso, los en cualquier momento y sin previo aviso, las características técnicas de los modelos ilustrados en este catálogo. Los colores son indicativos.*

associato a  
**ASSOLUCE**  
FEDERLEGNO-ARREDO

**ECO LIGHT**



MADE IN ITALY

**EGOLUCE s.r.l.**

Via I. Newton, 12 - 20016 Pero - Milano - Italy

Tel. +39 02339586.1 - Italia fax +39 023535112 - Int. fax +39 0233911087

E-mail: [export@egoluce.com](mailto:export@egoluce.com) - Int. E-mail: [infoworld@egoluce.com](mailto:infoworld@egoluce.com)

[www.egoluce.com](http://www.egoluce.com)